

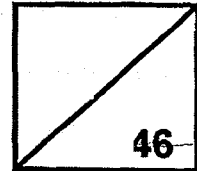

Rosyth School
Second Semestral Examination for 2018
SCIENCE
Primary 3

**Total
Marks:**



Name: _____

Class: Pr 3 - _____ **Register No.** _____ **Duration:** 1 h 30 min

Date: 31 October 2018 **Parent's Signature:** _____

Booklet A

Instructions to Pupils:

- 1. Do not open the booklets until you are told to do so.**
- 2. Follow all instructions carefully.**
- 3. This paper consists of 2 booklets, Booklet A and Booklet B.**
- 4. For questions 1 to 23 in Booklet A, shade the correct ovals on the Optical Answer Sheet (OAS) provided using a 2B pencil.**

*** This booklet consists of 13 printed pages (including cover page).**

Part 1

For each question from 1 to 23, four options are given. One of them is the correct answer. Make your choice (1, 2, 3 or 4). Shade the correct oval (1, 2, 3 or 4) on the Optical Answer Sheet. (46 Marks)

1. A snail hides itself in its shell when touched

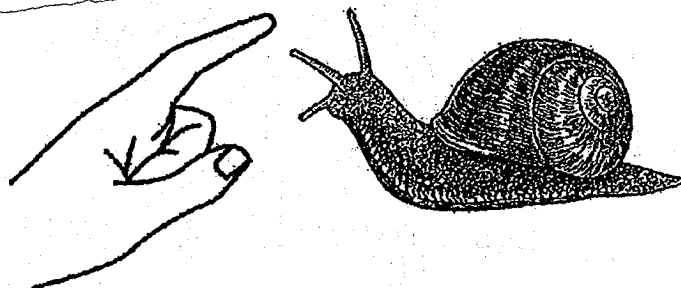

This shows that the snail is a living thing because it can _____.

- | | |
|-------------|---------------|
| (1) breathe | (2) grow |
| (3) respond | (4) reproduce |

2. Which one of the following statements is true for all insects?

- (1) They live on land.
- (2) They have wings.
- (3) They feed on other animals.
- (4) They have the same number of legs.

3. Study the chart below.

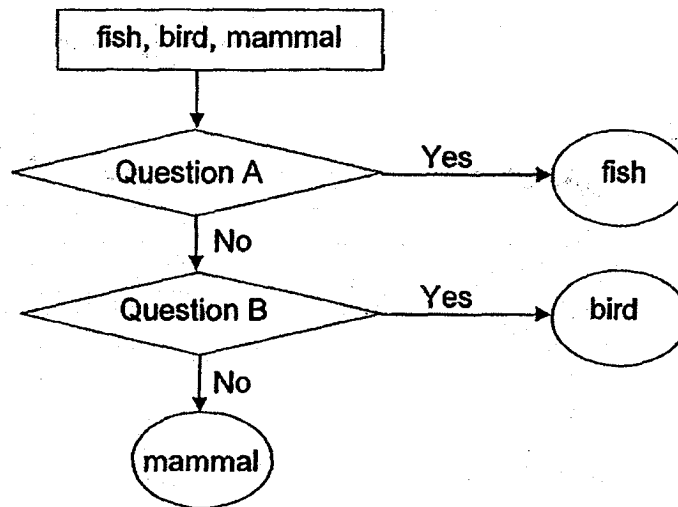

Which of the following are the missing questions A and B?

	Question A	Question B
(1)	Does it have gills?	Does it have hair?
(2)	Does it have a tail?	Does it have wings?
(3)	Does it have hair?	Does it have a beak?
(4)	Does it have fins?	Does it have feathers?

4. Which one of the following living things can bear flowers?

(1) fern



(2) banana plant



(3) mushroom

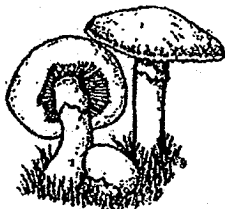

(4) bracket fungi

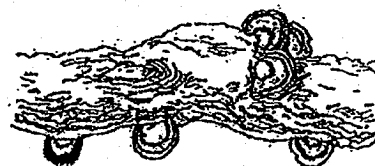

5. Ben compared two living things, P and Q.

Difference: P does not make its own food but Q makes its own food.

Similarity: Both P and Q reproduce from spores.

What could P and Q be?

	P	Q
(1)	fern	mushroom
(2)	flowering plant	mushroom
(3)	fern	flowering plant
(4)	mushroom	fern

6. How is bacteria similar to fungi?

- (1) Both are micro-organisms.
- (2) Both reproduce by spores.
- (3) Both are able to make food.
- (4) Both need air, food and water.

7. Study the diagram below.

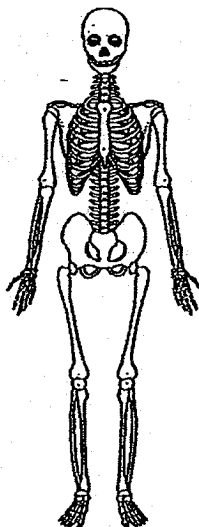

The above diagram shows the _____ system.

- (1) skeletal
- (2) digestive
- (3) muscular
- (4) respiratory

8. The picture below shows an organ system in the human body.

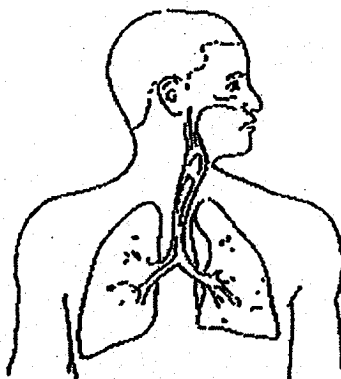

Which of the following statements are true of the organ system?

- A: The organ system is made up of different parts.
- B: Without the organ system, oxygen cannot be absorbed into the body.
- C: The organ system removes carbon dioxide from the body.

- (1) A and B only
- (2) A and C only
- (3) B and C only
- (4) A, B and C

9. Study the description about an organ system in the human body as shown below.

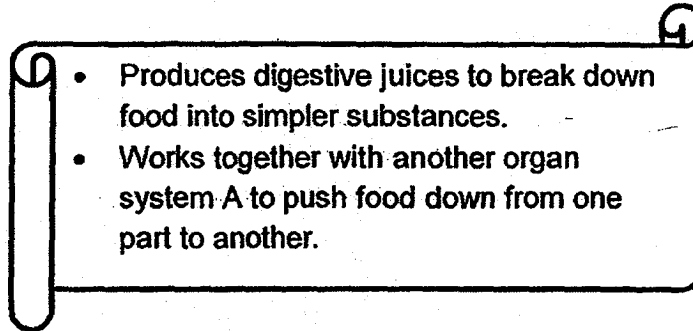

Which of the following is organ system A?

- (1) skeletal system
- (2) muscular system
- (3) respiratory system
- (4) circulatory system

10. Organ systems, P and Q are found in the human body. One of the functions of each organ system is described in the table below.

Organ System P	Organ System Q
<ul style="list-style-type: none"> • Works with another body system to enable different parts of the body to move. 	<ul style="list-style-type: none"> • Stores undigested food until it is removed.

Identify organ system P and organ system Q.

	Organ System P	Organ System Q
(1)	skeletal	digestive
(2)	circulatory	digestive
(3)	skeletal	circulatory
(4)	muscular	respiratory

11. Which one of the following shows correctly how the food travels through a human digestive system in a healthy person?

- (1) anus → large intestine → small intestine → stomach → gullet → mouth
- (2) stomach → gullet → mouth → anus → large intestine → small intestine
- (3) mouth → gullet → stomach → large intestine → small intestine → anus
- (4) mouth → gullet → stomach → small intestine → large intestine → anus

12. The diagram below shows a human digestive system.

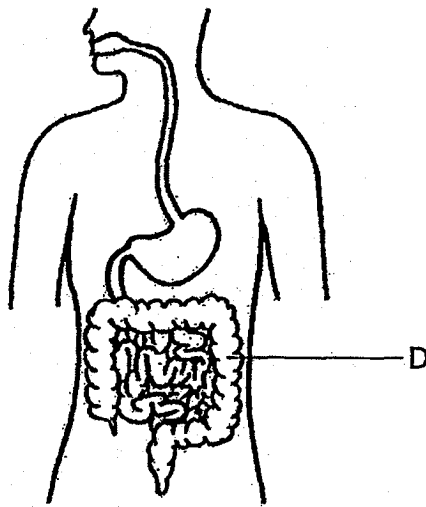

What would possibly happen when organ D is not functioning properly?

- (1) More digestive juices are produced.
- (2) Watery faeces will be passed out from the body.
- (3) Food will be broken up into smaller pieces slowly.
- (4) Undigested food will be removed from the stomach directly.

13. A model of the human digestive system was built as shown below. Each part of the model represents a part of the human digestive system. Use the model below to answer questions 13 and 14.

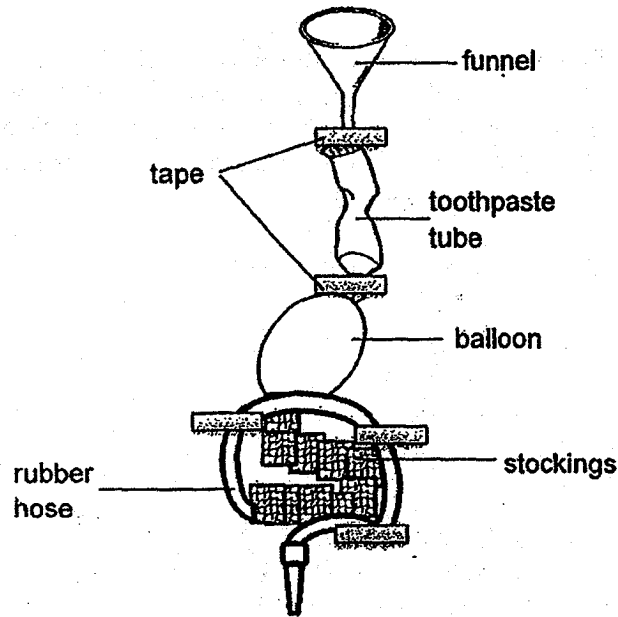

Which one of the following part of the model correctly represents the part of the human digestive system?

	Part of the Model	Part of the Human Digestive System
(1)	balloon	stomach
(2)	funnel	small intestine
(3)	stocking	gullet
(4)	toothpaste tube	mouth

14. If the rubber hose is the large intestine, it cannot perform the function of a large intestine.

Which one of the following best explains why the rubber hose cannot perform the function of a large intestine?

- (1) The rubber hose cannot absorb water.
- (2) The rubber hose cannot absorb digested food.
- (3) The rubber hose cannot produce digestive juices.
- (4) The rubber hose cannot cut the food into smaller pieces.

15. On a stormy day, a tree fell onto a house as shown below.

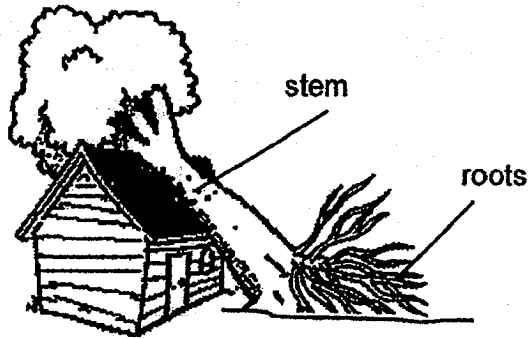

Which of the following best explains why the tree fell?

- (1) The stem is not strong.
- (2) The stem cannot support the tree.
- (3) The roots are not able to absorb water.
- (4) The roots are not able to hold it firmly to the ground.

16. Study the plant below.

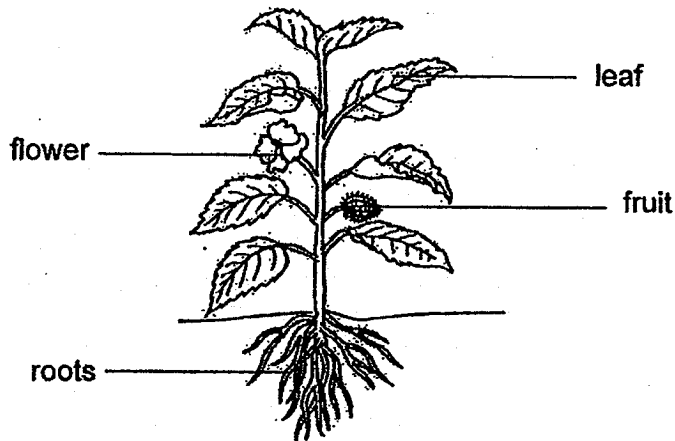

Which part of the plant makes food?

- (1) leaf
- (2) fruit
- (3) flower
- (4) roots

17. There are three similar adult plants, A, B and C. They are placed under the sun and watered every day. One part of each plant is removed completely as shown in the table below.

Plant	Part of the Plant that is Removed Completely
A	roots
B	fruits
C	flowers

After one month, which of the following plant(s) will not die?

- (1) A only
- (2) B only
- (3) A and C only
- (4) B and C only

18. Study the table below.

X	Y
chopsticks	wood
vase	ceramic
knife	metal

Which one of the following are suitable headings in place of X and Y?

	X	Y
(1)	Objects	Materials
(2)	Objects	Uses
(3)	Materials	Properties
(4)	Materials	Uses

19. The camping tent shown below keeps out the rain and the sun. It can be folded easily when not in use.

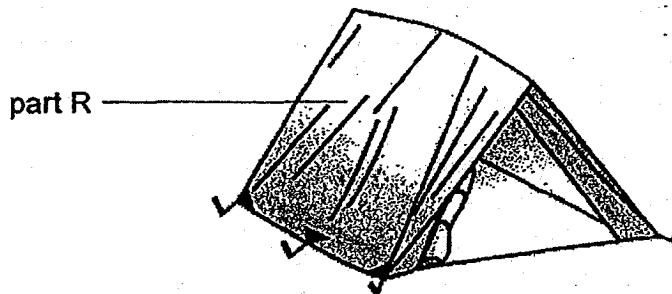

Which of the following most correctly states the properties of part R?

	Allows light to pass through	Waterproof	Flexible
(1)	Yes	Yes	Yes
(2)	Yes	No	No
(3)	No	Yes	Yes
(4)	No	No	No

22. The diagram below shows a flow chart.

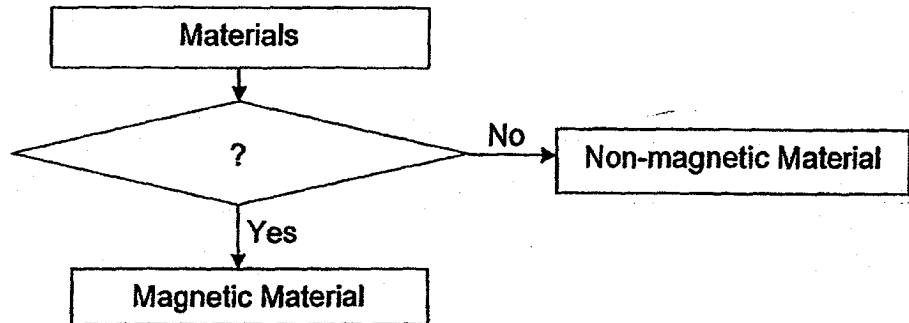

Which one of following is the missing question in the box?

- (1) Is it a metal?
- (2) Can it be made into a magnet?
- (3) Can it be repelled by a magnet?
- (4) Does it have a north and south pole?

23. Jill stroked two similar iron rods, A and B, with the same magnet as shown below.

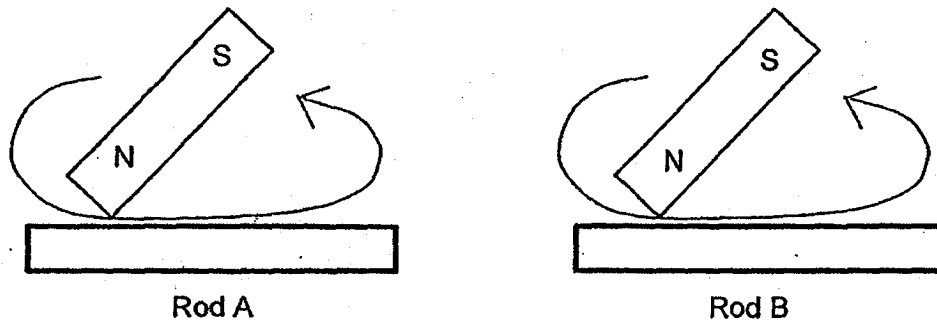

Both rods became magnets.
Rod A attracted fewer pins than rod B.

Which one of the following shows the possible number of strokes used for rod A and rod B respectively?

	Rod A	Rod B
(1)	30	30
(2)	15	30
(3)	15	15
(4)	30	15

End of Booklet A

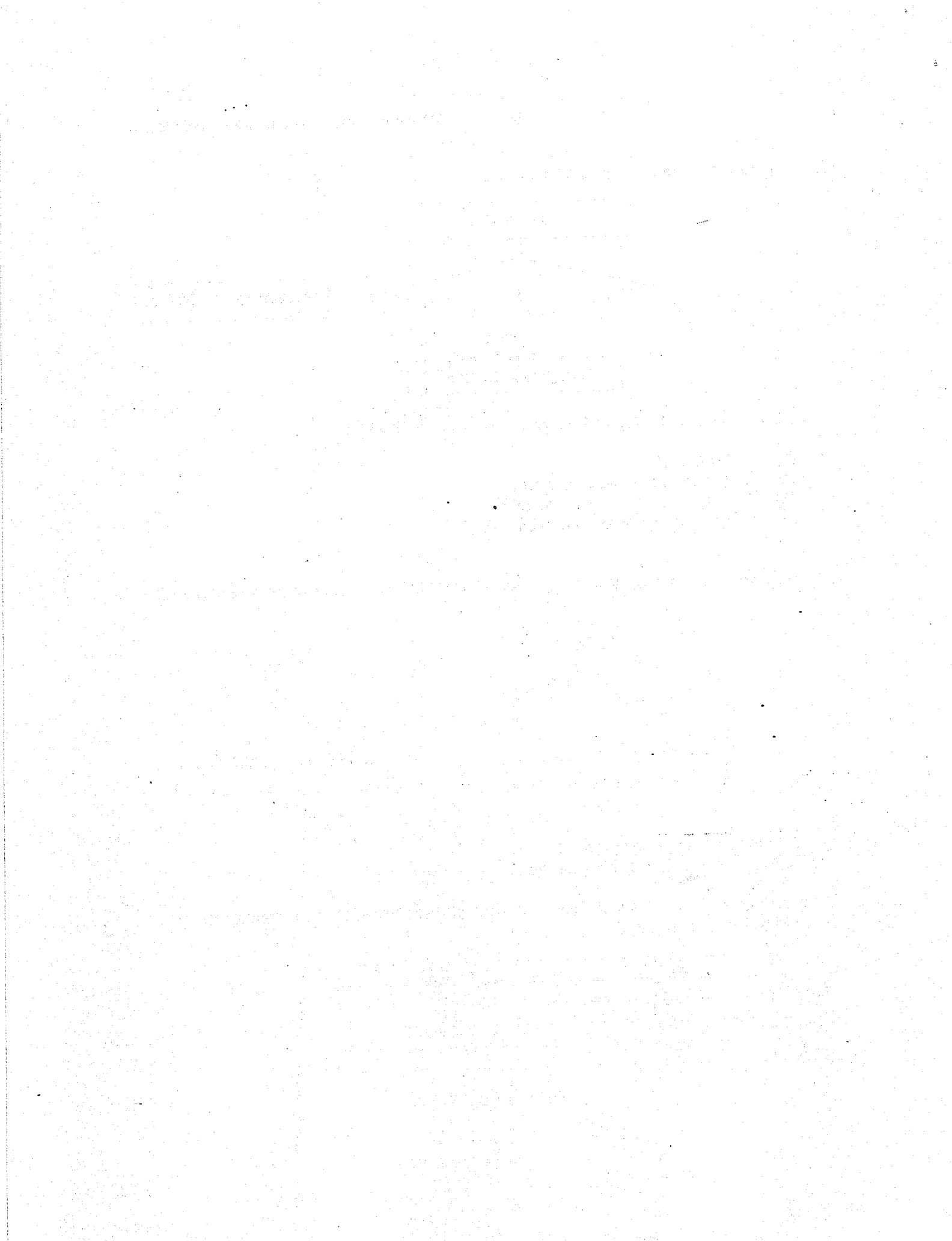



Rosyth School
Second Semestral Examination for 2018
SCIENCE
Primary 3

Name: _____

Total
Marks:

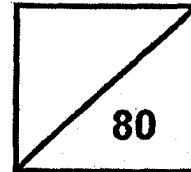

Class: Pr 3 - _____ Register No. _____ Duration: 1 h 30 min

Date: 31 October 2018 Parent's Signature: _____

Booklet B

Instructions to Pupils:

1. For questions 24 to 34, write your answers in the spaces given in this booklet.

	Maximum	Marks Obtained
Booklet A	46 marks	
Booklet B	34 marks	
Total	80 marks	

* This booklet consists of 11 printed pages (including cover page).

Part II

For questions 24 to 34, write your answers in the space provided.

(34 Marks)

24. Ron conducted an experiment from January to April. He set up two tanks, A and B, with two different things. Both tanks were provided with air, water and food. Every month, Ron counted the number of things in both tanks and drew the bars as shown below.

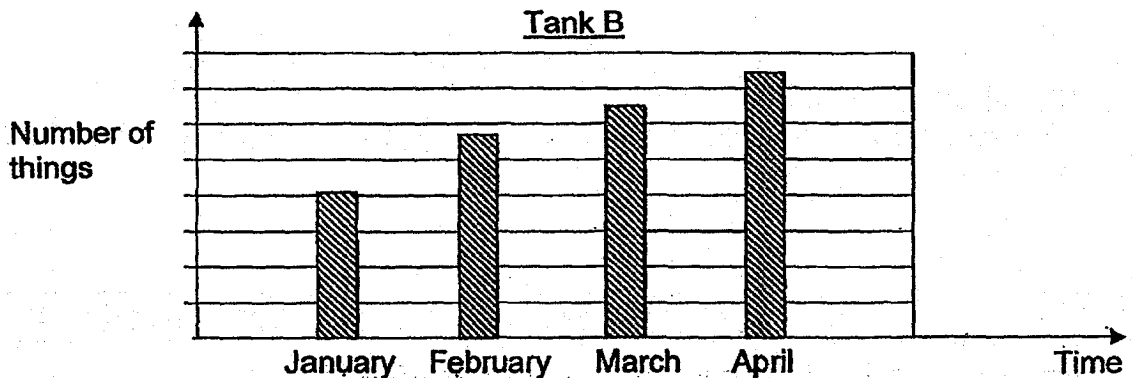
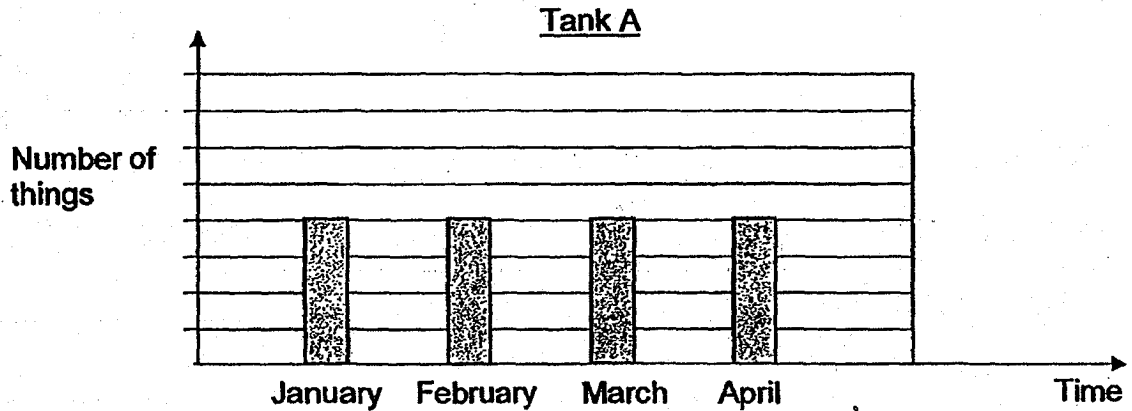

- (a) Based on the graph above, which tank possibly contained a living thing? Write A or B in the blank. [1]

Tank _____

- (b) Explain how you arrive at your answer in (a). [1]

25. A scientist discovered an animal Y in a jungle. He made an observation of the animal as listed below.

Feeds its young with milk

(a) Which group of animals does Y belong to? [1]

(b) Write down another characteristic of animal Y which other groups of animals do not have. [1]

The picture below shows another animal, Z, that the scientist saw in the forest.

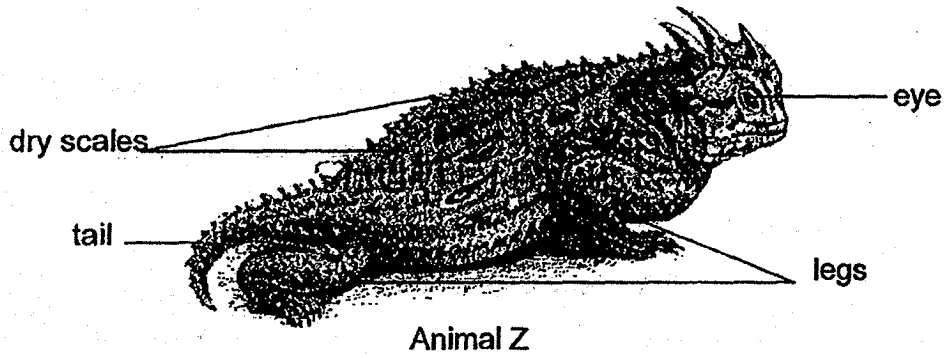

(c) Which group of animals does Z belong to? Give your reason. [2]

26. Study the classification table below.

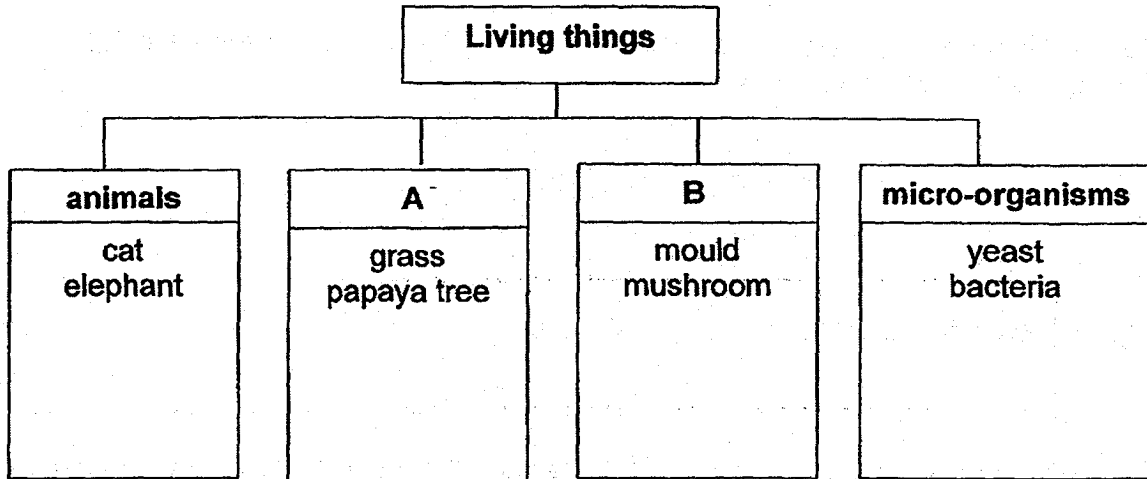

(a) Write down suitable headings for A and B. [1]

A: _____

B: _____

(b) Classify 'fern' using the classification table above. Write 'Fern' in the correct box. [1]

27. Match the correct human body system to its function. [2]

Function	Human Body System
Allows the exchange of gases to take place. •	• circulatory system
Carries food, water and oxygen to various parts of the body. •	• respiratory system
Supports the body and gives it shape. •	• muscular system
Helps different parts of the body to move. •	• skeletal system

28. Susan classified the parts of the organ systems as shown below.

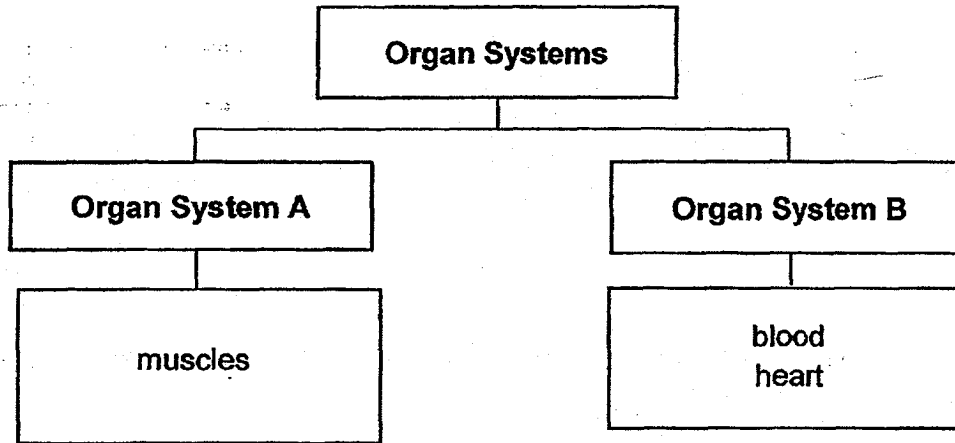

(a) Provide a suitable heading for the following: [2]

Organ System A: _____

Organ System B: _____

(b) In which organ system, A or B, should Susan place the "blood vessels"? [1]

Organ System

29. The graph below shows the amount of digested food in different parts, A, B, C and D of a human digestive system. The parts are not in the correct order.

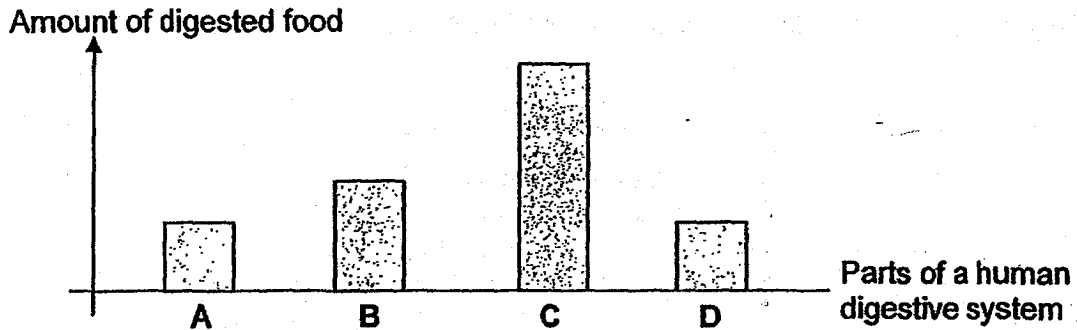

- (a) Using the results, identify parts C and D of a human digestive system by completing the table below.

Part A is the gullet. Part B is the stomach. They have already been done for you. [2]

Parts of a Human Digestive System	Part
<i>gullet</i>	A
mouth	
<i>stomach</i>	B
small intestine	

- (b) Which organ system will transport the digested food from the small intestine to other parts of the body? [1]
-

30. The diagram below shows some organs in the digestive system.

(a) Label the organs.

[2]

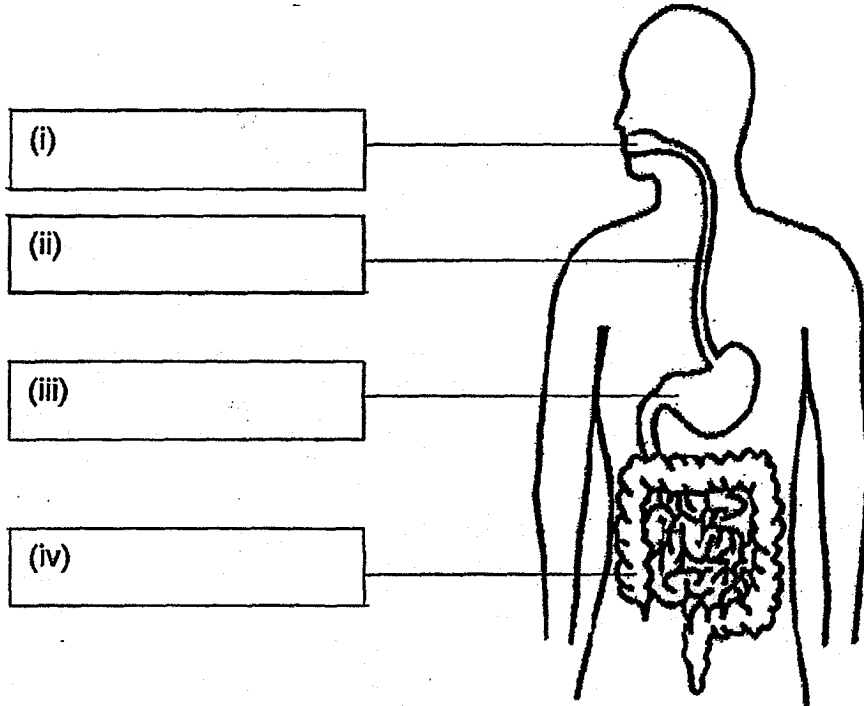

The diagram below shows a pair of scissors used to cut paper.

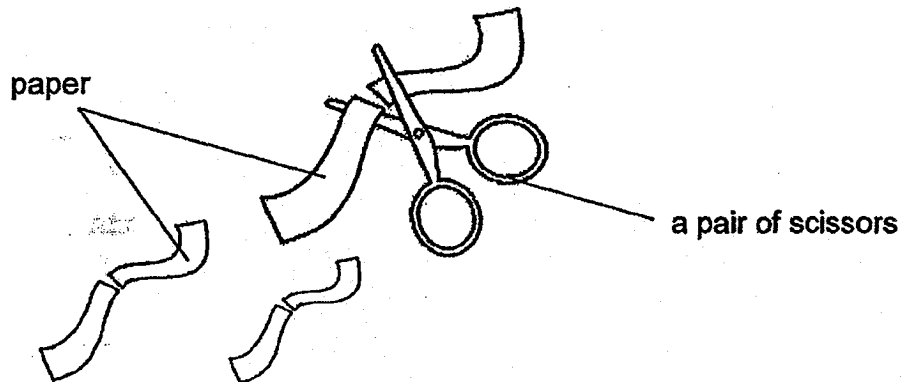

(b) Which organ in the digestive system has the similar function as a pair of scissors? Give a reason to your answer. [2]

31. Study the flowchart below.

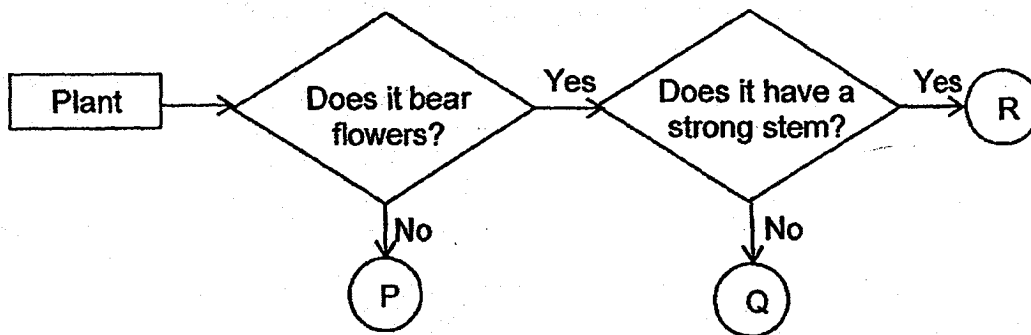

(a) State one characteristic of plant Q.

[1]

(b) State one difference between plant P and plant Q.

[1]

(c) State one similarity between plant Q and plant R.

[1]

32. Arul observed a plant growing in his garden.

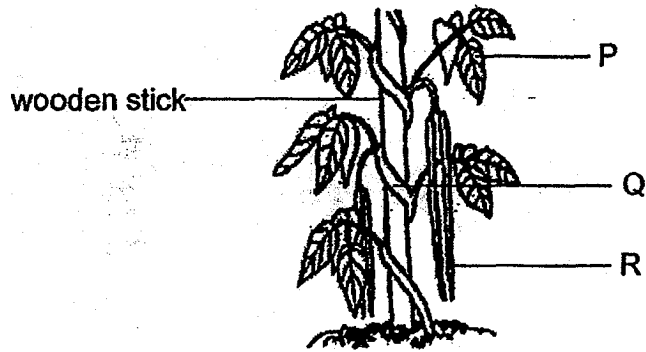

(a) Name parts P and Q shown in the plant above.

[2]

Part P: _____

Part Q: _____

(b) How does the wooden stick help the plant?

[1]

(c) Part R is the fruit of the plant. What is found inside R that helps it to reproduce?

[1]

33. Baoli had the following set-up for her experiment.

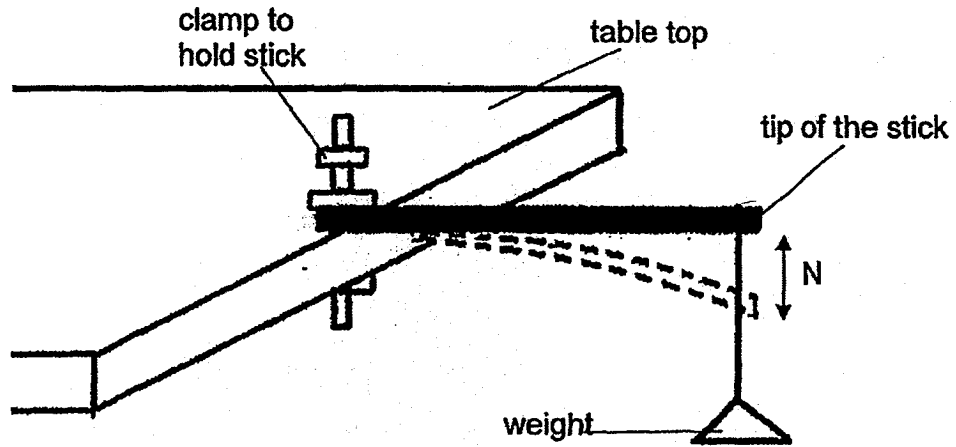

She measured N , the distance travelled by the tip of the stick when a weight is hung on it. She repeated the experiment with stick Y which is made of a different material.

(a) What property was Baoli testing?

[1]

Baoli recorded her results as shown below.

	Stick X	Stick Y
N (Distance travelled by the tip of the stick when a weight is hung on it.)	5 cm	0 cm

The diagram below shows a pair of chopsticks and its use.

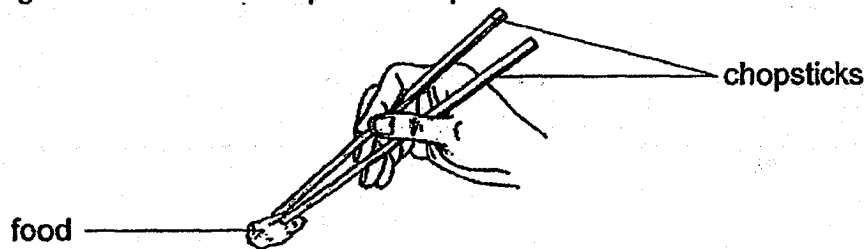

(b) Which stick, X or Y, is more suitable for making a pair of chopsticks? Explain your answer.

[2]

34. Sammy made an electromagnet as shown below.

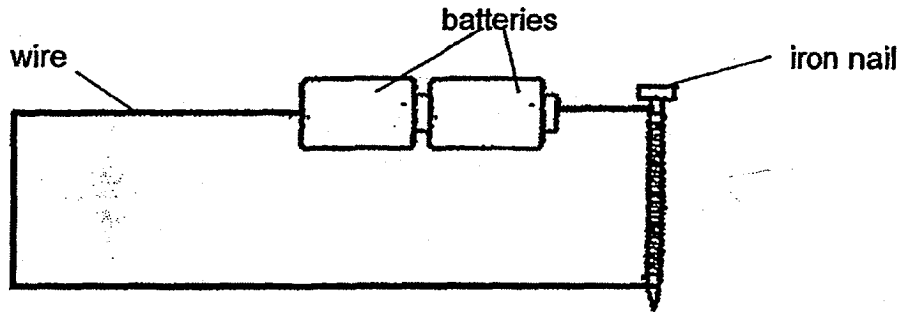

(a) What could Sammy do to find out if the iron nail had become an electromagnet?

[1]

(b) State 2 changes that Sammy could do to increase the strength of the electromagnet.

[2]

(i) _____

(ii) _____

Sammy placed two magnets together as shown below.

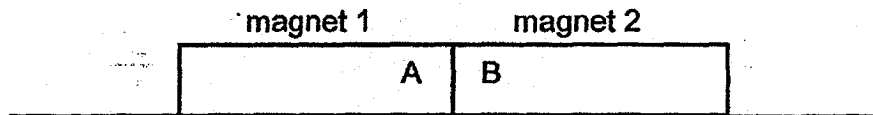

(c) Fill in the blank below with the correct word.

Based on the above observation, Sammy inferred that A and B are

_____ poles.

[1]

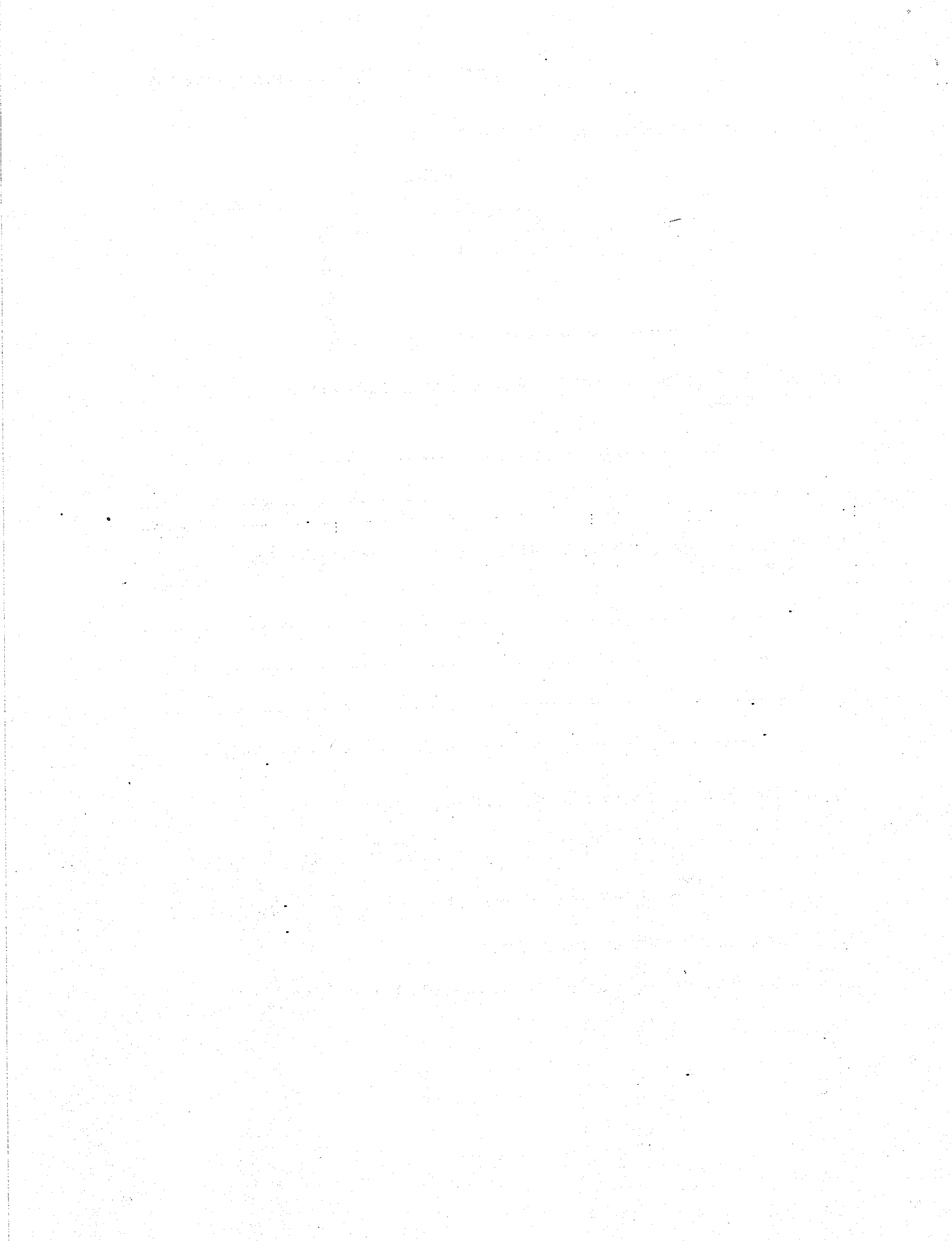

EXAM PAPER 2018 (P3)

SCHOOL : Rosyth

SUBJECT : SCIENCE

TERM : SA2

Q1	Q2	Q3	Q4	Q5	Q6	Q7	Q8	Q9	Q10
3	4	4	2	4	4	1	4	2	1
Q11	Q12	Q13	Q14	Q15	Q16	Q17	Q18	Q19	Q20
4	2	1	1	4	1	4	1	3	1
Q21	Q22	Q23							
3	2	2							

Q24) a) Tank B

b) The number of living thing in tank B increases as living things reproduce.

Q25) a) mammal

b) They have hair as outer covering

c) Reptile because it has dry scales.

Q26) a) A : plants

B : fungi

b) box A

Q27)

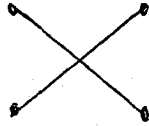
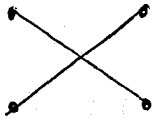

Q28) a) Organ System A : muscular system.

Organ System B : circulatory system

b) Organ System B

Q29) a) mouth – D small intestine – C

b) circulatory system

Q30) a) i) mouth ii) gullet iii) stomach iv) small intestine

b) Mouth. Because it chew the food into smaller pieces just like the scissor.

Q31) a) Plant Q is a flowering plant.

b) Plant Q bear flowers but plant P does not bear flowers.

c) Both bear flowers.

Q32) a) Part P : leaves

Part Q : stem

b) It helps to support the plant from falling.

c) seeds

Q33) a) flexibility

b) Y. Less flexible while X when a weight was added chopsticks must be stiff when picking up food.

Q34) a) Put the iron nail near to some iron clips it should attract some of them.

b) i) Increase the number of batteries.

ii) Increase the number of coils around the iron nail

c) unlike poles.

