



PEI HWA PRESBYTERIAN PRIMARY SCHOOL
SEMESTRAL ASSESSMENT 1

PRIMARY 4
MATHEMATICS PAPER

11 MAY 2016

Name: _____

Form Class / Register No. : 4TW _____ / _____

Banded Class / Register No. : 4M _____ / _____

Total time: 1 h 45 min

INSTRUCTIONS TO CANDIDATES

1. Write your Name, Class and Register No. in the spaces provided above.
2. DO NOT turn over this page until you are told to do so.
3. Follow all instructions carefully.
4. Answer all questions.
5. For Section A, shade your answers on the Optical Answer Sheet (OAS) provided.
6. For Section B and C, write all your answers in this booklet
7. The use of calculator is **NOT ALLOWED**.

Total Marks :

100

This booklet consists of 22 printed pages, excluding the cover page.

Section A: Multiple Choice Questions (20 × 2 = 40 marks)

For each question, four options are given. One of them is the correct answer. Make your choice (1, 2, 3 or 4). Shade the oval (1, 2, 3 or 4) on the Optical Answer Sheet.

1. In which of the following numbers does the digit 5 have a value of 5 000?

- (1) 89 065
- (2) 67 251
- (3) 52 479
- (4) 35 795

()

2. Which one of the following is not a factor of 64?

- (1) 32
- (2) 14
- (3) 8
- (4) 4

()

3. The product of 246 and 13 is _____.

- (1) 3088
- (2) 3188
- (3) 3189
- (4) 3198

()

4. Express $2\frac{4}{7}$ as an improper fraction.

- (1) $\frac{8}{7}$
- (2) $\frac{14}{7}$
- (3) $\frac{18}{7}$
- (4) $\frac{4}{14}$

()

5. Find the value of $\frac{1}{6} + \frac{5}{12}$.

(1) $\frac{1}{2}$

(2) $\frac{5}{72}$

(3) $\frac{6}{18}$

(4) $\frac{7}{12}$

()

6. The product of 8 and a number is 7608. What is the number?

(1) 826

(2) 951

(3) 5684

(4) 6084

()

7. Find the missing number in the box.

$$\frac{1}{2} + \frac{1}{\boxed{?}} + \frac{1}{4} = \frac{11}{12}$$

(1) 6

(2) 12

(3) 3

(4) 4

()

8. Jeremy used $\frac{3}{10}$ kg of cherries to bake a pie and had $\frac{2}{5}$ kg of cherries left.

How many kg of cherries did he have at first?

(1) $\frac{1}{10}$

(2) $\frac{1}{5}$

(3) $\frac{1}{3}$

(4) $\frac{7}{10}$

()

9. Tricia bought some stationery consisting of erasers and pencils. $\frac{3}{8}$ of the stationery bought were erasers. Tricia bought 24 erasers. How many pencils did she buy?

(1) 8

(2) 30

(3) 40

(4) 64

()

10. Annie had twice as many paper clips as Beth. After Beth had used 15 paper clips, Annie had 4 times as many as Beth. How many paper clips did Annie have?

(1) 15

(2) 45

(3) 60

(4) 75

()

11. Barry spent $\frac{3}{4}h$ completing his Chinese homework. He spent $\frac{1}{6}h$ less on his English homework. How much time did he spend on both his Chinese and English homework altogether?

(1) $\frac{7}{12}h$

(2) $\frac{10}{16}h$

(3) $1\frac{1}{3}h$

(4) $1\frac{3}{4}h$

()

12. In the figure below, which angle is greater than a right angle?

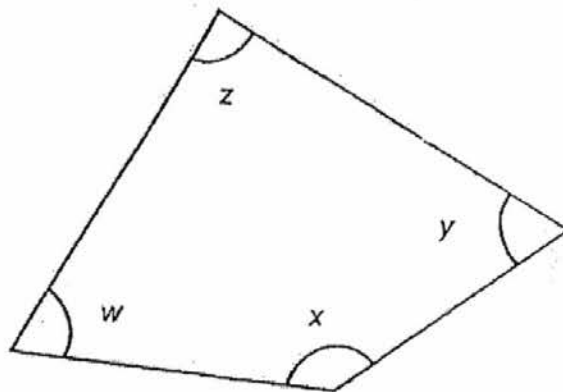

(1) $\angle w$

(2) $\angle x$

(3) $\angle y$

(4) $\angle z$

()

13. Joanne is facing South. She makes a $\frac{1}{4}$ -turn in a clockwise direction.
Which direction is Joanne facing after making the turn?

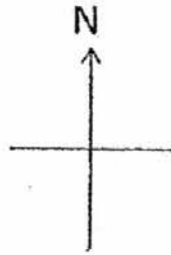

- (1) East
- (2) West
- (3) North
- (4) South

()

Refer to the 8-point compass below and answer questions 14 and 15.

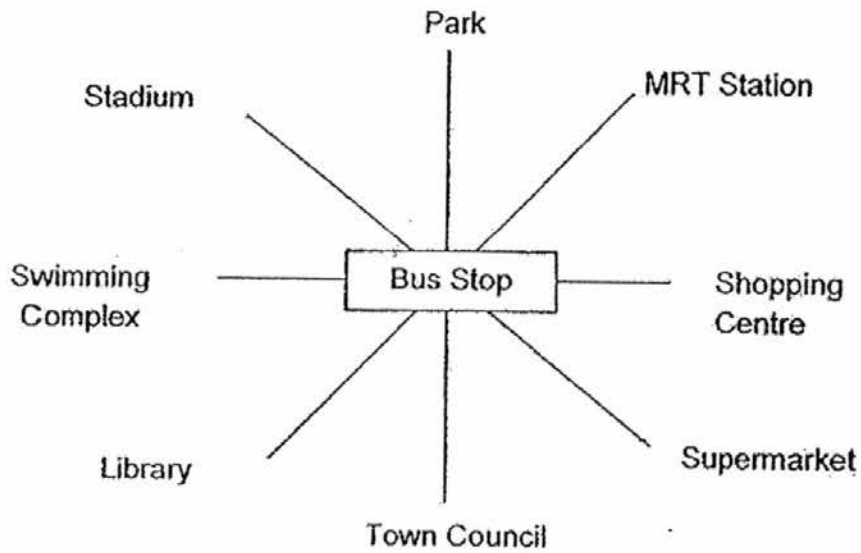

14. Alvin is at the bus stop facing the Stadium, what is the angle in the anti-clockwise direction that he has to turn in order to face the Shopping Centre?

- (1) 135°
- (2) 180°
- (3) 225°
- (4) 270°

()

15. Ren Yi was standing at the Bus Stop. After turning 135° in an anti-clockwise direction, Ren Yi faced the MRT Station. Where was Ren Yi facing before the turn?

- (1) Library
- (2) Supermarket
- (3) Swimming Complex
- (4) Town Council

()

16. ABCD is a rectangle. Find $\angle g$.

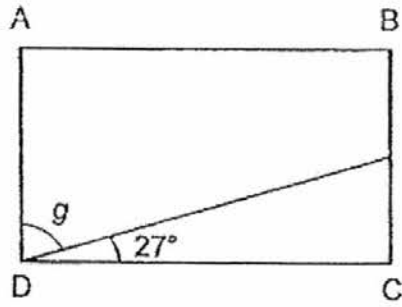

- (1) 63°
- (2) 73°
- (3) 117°
- (4) 153°

()

17. The figure shown below is made up of Rectangle E of breadth 8 cm and Square F with sides 5 cm. What is the length of the rectangle?

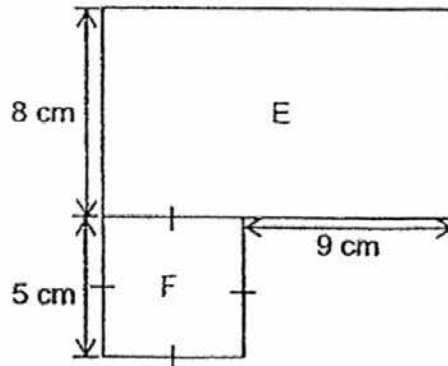

- (1) 10 cm
- (2) 13 cm
- (3) 14 cm
- (4) 17 cm

()

18. A square piece of paper is folded as shown. Find $\angle y$.

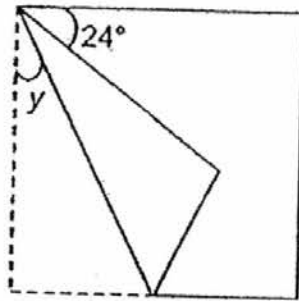

- (1) 21°
 (2) 33°
 (3) 66°
 (4) 78°

()

19. Which one of the following figures is symmetrical?

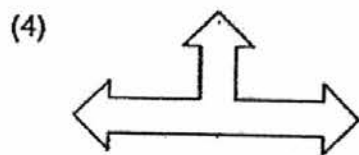
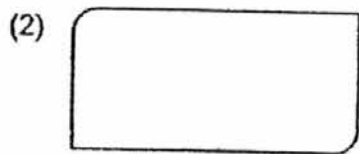
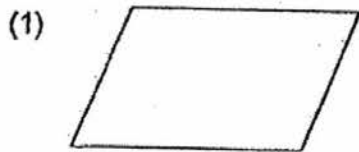

()

20. Which one of the following figures has the dotted line as a line of symmetry?

(1)



(2)

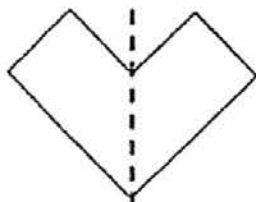

(3)

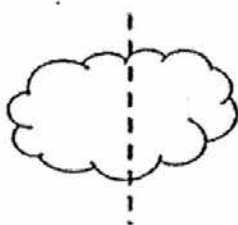

(4)

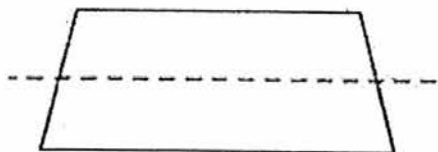

()

Section B (20 × 2 = 40 marks)

Write your answers in the answer blanks provided.
For questions that require working, show your working clearly in the space provided.

21. Write 20 thousands, 17 hundreds, 3 tens and 21 ones in numerals.

Answer: _____

22. Complete the number pattern.

12 882, 13 032, 13 332, 13 782, _____, 15 132

Answer: _____

23. Find the first common multiple of 6 and 10.

Answer: _____

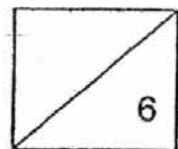

24. Danny runs at the park once every 3 days and plays soccer once every 5 days. If he both runs at the park and plays soccer on 11th May, when will be the next time he both runs and plays soccer again?

Answer: _____ May

25. What is the remainder when you divide 836 by 7?

Answer _____

26. The mass of a chair is 2678 g. What is the total mass of 4 such chairs? Round off your answer to the nearest thousand?

Answer: _____ g

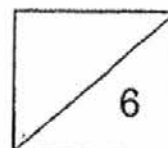

27. Mr Ramdan bought 2 tins of biscuits. One tin contained 3500 g of biscuits and the other contained 4550 g of biscuits. He repacked all the biscuits equally into 7 smaller packets. What was the mass of the biscuits in each packet?

Answer: _____ g

28. Uncle Sam had an equal number of oranges and apples at first. After he threw away 34 rotten oranges and 100 rotten apples, he had 3 times as many oranges as apples. How many apples did he have at first?

Answer: _____

29. Mdm Lee bought a total of 11 slices of cakes and some fruit tarts for a gathering. Each slice of cake cost \$5 and each fruit tart cost \$2. She paid a total of \$83. How many fruit tarts did Mdm Lee buy?

Answer: _____

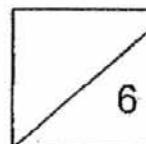

30. Use a protractor to measure and write down the size of $\angle ABD$.

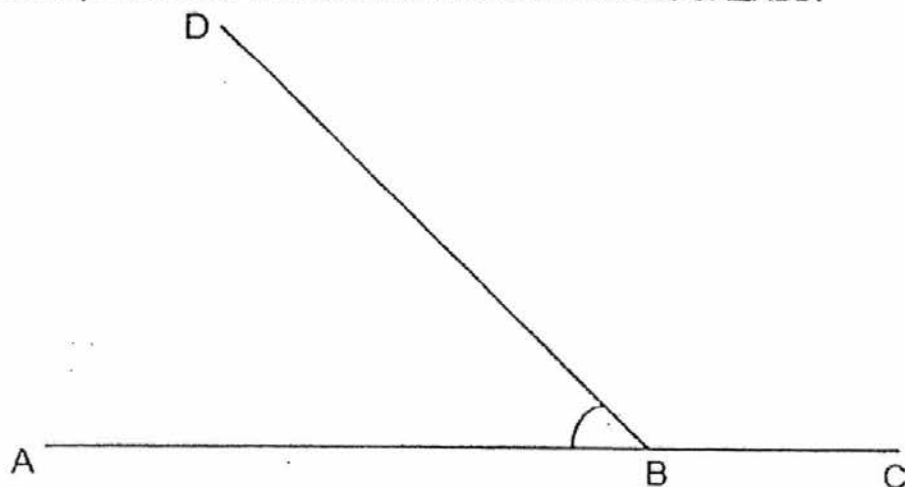

Answer: _____

31. Using the given protractor and the line AB below, draw $\angle CBA$ of 155° .

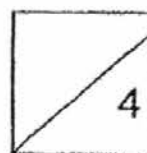
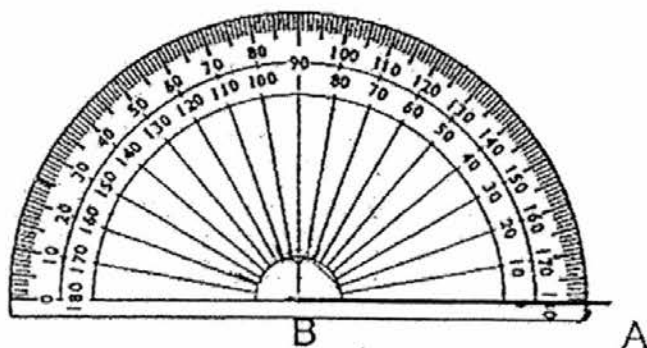

32. The clock below shows 3.10 p.m. What is the time shown on the clock when the minute hand moves $\frac{3}{4}$ -turn in a clockwise direction?



Answer: _____ p.m.

33. Look at the grid below. Ravi was at Point Q. He moved 1 step to the north, 3 steps to the west and finally 2 steps to the south. Mark with the letter 'X' where Ravi was in the end.

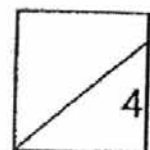
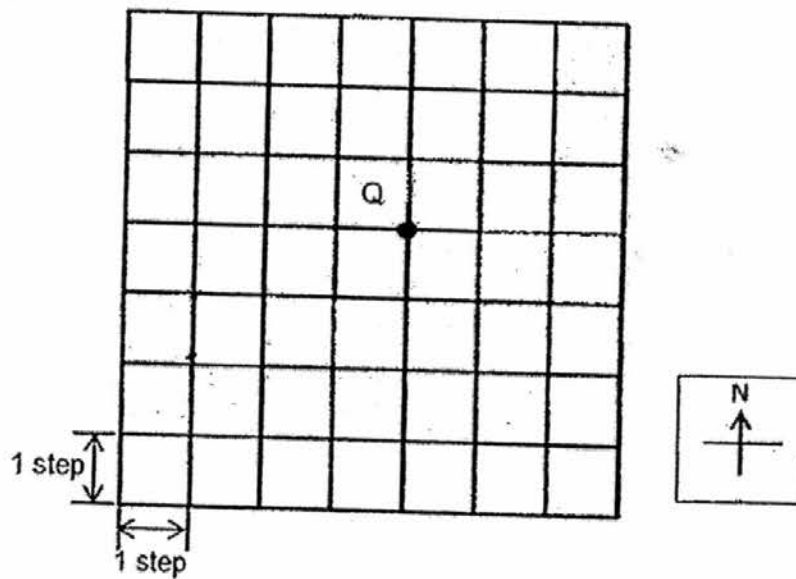

34. The grid below is filled with 1-cm squares.
 Draw and label a rectangle WXYZ in which $WX = 9\text{ cm}$ and $XY = 5\text{ cm}$.

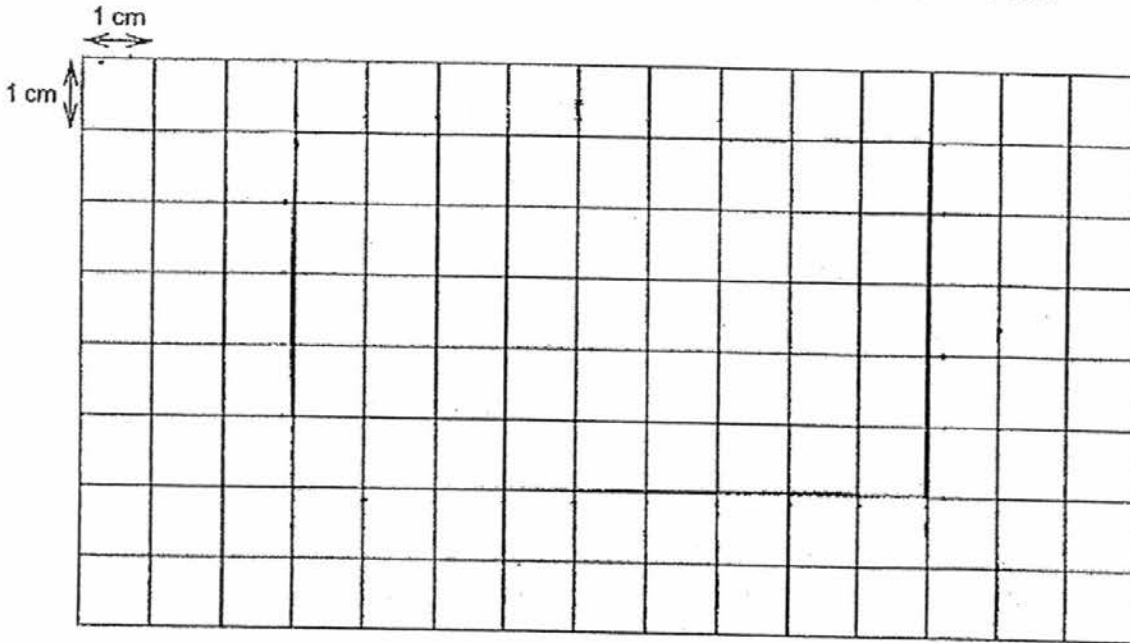

35. The dotted line below is a line of symmetry. Shade the correct squares on the left side of the picture to make a symmetric figure.

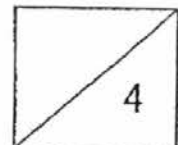
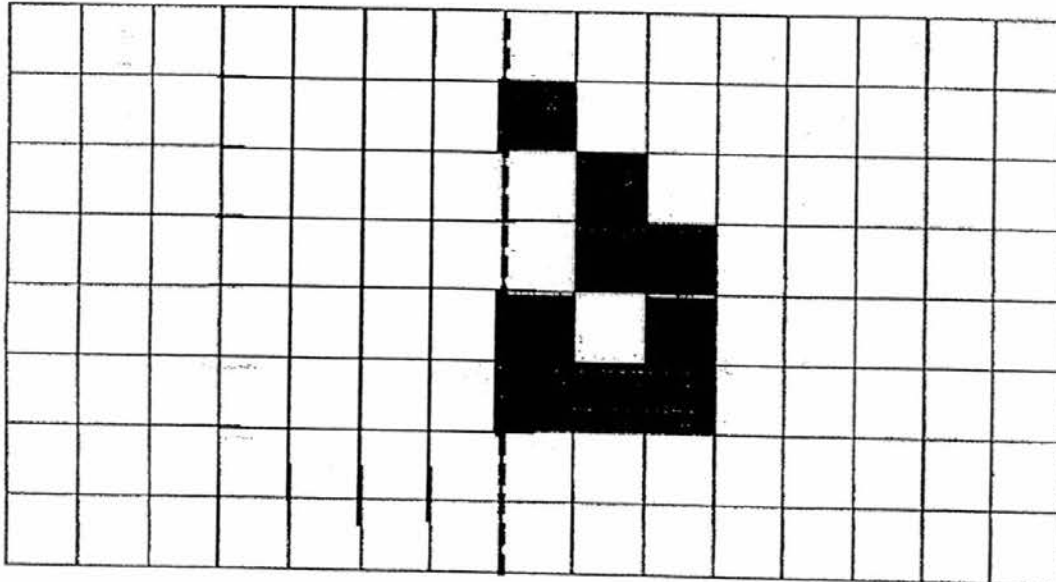

36. Arrange the following fractions from the greatest to the smallest.

Answer: _____, _____, _____
 (greatest) (smallest)

37. The figure below is made up of 2 identical overlapping squares, ABCD and EFGH. The length of each side of the shaded part is $\frac{1}{3}$ the length of each square where $HK = KL = LG$. What fraction of the figure is not shaded?

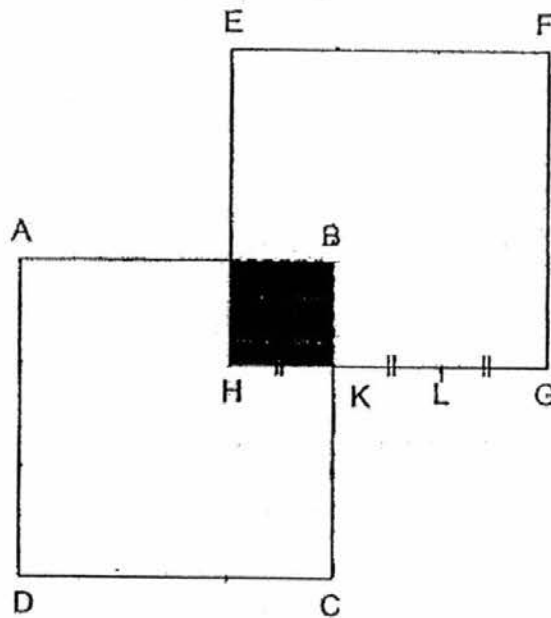

Answer: _____

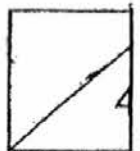

38. $3 - \frac{5}{12} - \frac{1}{4} =$ _____ . Give your answer in the simplest form.

Answer: _____

39. 180 people went for a concert. $\frac{1}{3}$ of the people were men, $\frac{4}{9}$ of them were women and the rest were children. How many children attended the concert?

Answer: _____

40. Farah writes two fractions that are smaller than 1. She asks Jia Qi to guess the two fractions and gives her the following hints:

- The sum of the fractions is $1\frac{1}{2}$.

- The difference between the fractions is $\frac{1}{6}$.

What are the two fractions?

Answer: _____ and _____

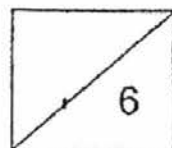

Section C (5 x 4 = 20 marks)

Solve each of the following problems. Show all your working and statements clearly. Write your answers in the spaces provided.

41. The mass of a container with 80 identical metal balls is 940 g. When 20 of the balls are removed, the mass of the container with the remaining balls is 780 g. What is the mass of the container?

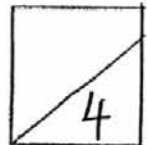

Working

Answer: _____



42. A gift shop sold two types of personalised stickers in packs at the prices shown below.

Working

	
<p style="text-align: center;">Picture Stickers</p> <p style="text-align: center;">Pack of 3 sheets for \$10</p>	<p style="text-align: center;">Name Stickers</p> <p style="text-align: center;">Pack of 3 sheets for \$14</p>

The shop sold a total of 384 sheets of stickers. The number of sheets of Picture Stickers sold was 7 times the number of sheets of Name Stickers sold. How much money was collected from the sale of Name Stickers?

Answer: _____

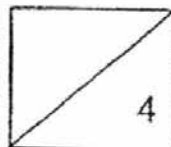

43. Every day, Fred makes 30 cards while Mike makes 2 cards. Presently, Fred has made 912 cards and Mike has made 996 cards. How many days will it take for both of them to make the same number of cards at the end?

Working

Answer: _____

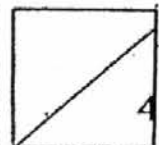

44. The figure below (not drawn to scale) shows the floorplan of Hope Primary School which is made up of 2 rectangles ABCD and PQRS.

The school is planning to fence up the perimeter of the school.

If 1 m of fencing cost \$18, find the total cost of fencing the school.

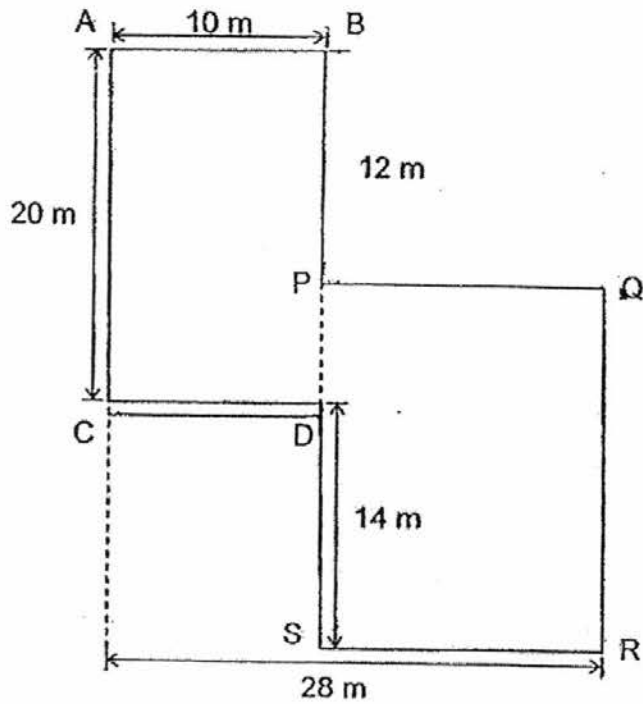

Working

Answer: _____

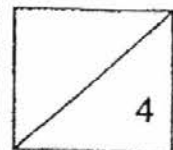

45. Box A contains $\frac{1}{3}$ kg of strawberries. Box B contains $\frac{3}{4}$ kg of strawberries.

How much strawberries must Nisha transfer from Box B to Box A so that Box B will contain $\frac{1}{12}$ kg more strawberries than Box A?

Give your answer in the simplest form.

Working

Answer: _____

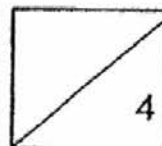

***** END OF PAPER *****
PLEASE CHECK YOUR WORK.

EXAM PAPER 2016 (P4)

SCHOOL : PEI HWA

SUBJECT : MATHEMATICS

TERM : SA1

Q1	Q2	Q3	Q4	Q5	Q6	Q7	Q8	Q9	Q10
4	2	4	3	4	2	1	4	3	3
Q11	Q12	Q13	Q14	Q15	Q16	Q17	Q18	Q19	Q20
3	2	2	3	4	1	3	2	4	2

21)21751 22)14382 23)30 24)26th 25)3 26)11000g

27)1150g 28)133 29)14 30)44° 31)

32)3.55p.m. 33)

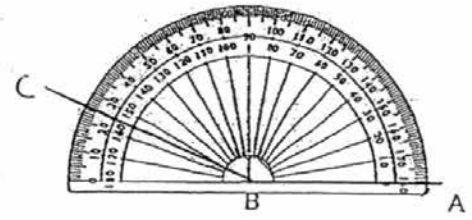
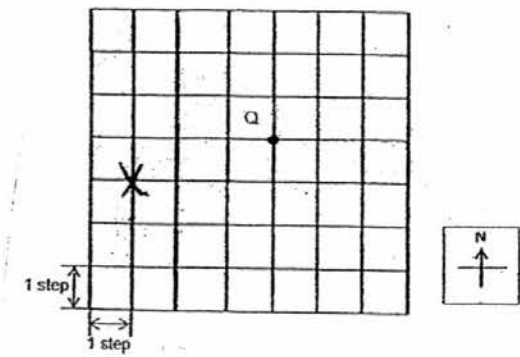

34)

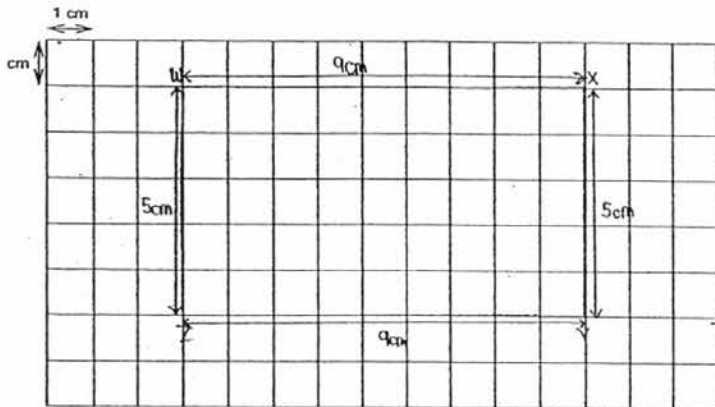

35)

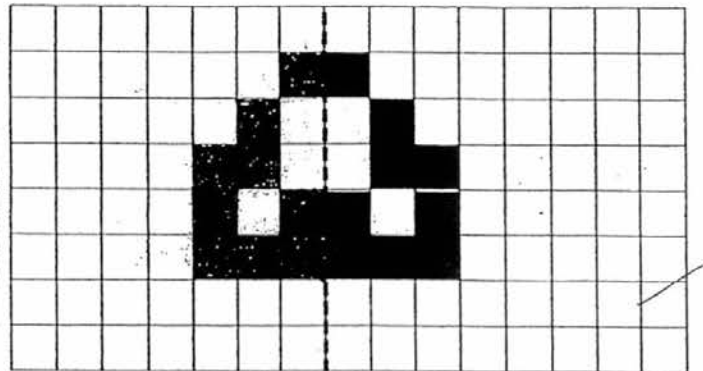

36) $3/5, 3/7, 1/3$ 37) $16/17$

38) $36/12 - 5/12 - 3/12 = 28/12$

$= 24/12 = 2$

39) 40

40) $4/6$ and $5/6$

41) Metal Balls \rightarrow MB

Container \rightarrow C

$80 \text{ MB} + 1 \text{ C} = 940 \text{ g}$

$80 - 20 = 60$

$60 \text{ MB} + 1 \text{ C} = 780 \text{ g}$

$20 \text{ MB} \rightarrow 940 \text{ g} - 780 \text{ g} = 160 \text{ g}$

$1 \text{ MB} \rightarrow 160 \div 20 = 8 \text{ g}$

$60 \text{ MB} \rightarrow 60 \times 8 \text{ g} = 480 \text{ g}$

$1 \text{ C} \rightarrow 780 \text{ g} - 480 \text{ g} = 300 \text{ g}$

42) $1u \rightarrow 384 \div 8 = 48$

$48 \div 3 = 16$

Money collected from Name stickers $\rightarrow 16 \times \$14 = \224

43) Fred: 912, 942, 972, (1002)

Mike: 996, 998, 1000, (1002)

It will take 3 days for both of them to make the same number of cards at the end.

44) PD $\rightarrow 20 - 12 = 8$

AR $\rightarrow 20 + 14 = 34$

Perimeter $\rightarrow 34 + 28 + 34 + 28 = 124$

Cost of fencing $\rightarrow 124 \times 18 = 2232$

The total cost of fencing the school is \$2232

45) $1/3 = 4/12$ $3/4 = 9/12$

$9/12 - 2/12 = 7/12$

$4/12 + 2/12 = 6/12$

$2/12 = 1/6$

Nisha must transfer $1/6$ kg strawberries from Box B to Box A.