

**METHODIST GIRLS' SCHOOL (Primary)**  
**2009 End-of-Year Examination**  
**Primary 4**

**MATHEMATICS**

**BOOKLET A**

Name: \_\_\_\_\_ (       )

Class: P 4. \_\_\_\_\_

<b>Booklet A (40)</b>	
-----------------------	--

Total time for Booklets A, B and C: 1 h 45 min

---

Do not turn over this page until you are told to do so.

Follow all instructions carefully.

Answer all questions.

This booklet consists of 12 printed pages.

**Section A (40 marks)**

For each of the following question, four options are given.

One of them is the correct answer.

Make your choice (1, 2, 3, 4). Shade the oval (1, 2, 3, 4) on the Optical Answer Sheet.

1. 45 thousands and 3 tens is the same as \_\_\_\_\_.

- (1) 453
- (2) 4 530
- (3) 45 003
- (4) 45 030

2. In which of the following are the numbers arranged from the smallest to the greatest?

- |     | <i>(smallest)</i> |         | <i>(greatest)</i> |
|-----|-------------------|---------|-------------------|
| (1) | 4 680 ,           | 4 608 , | 4 068             |
| (2) | 4 068 ,           | 4 680 , | 4 608             |
| (3) | 4 680 ,           | 4 068 , | 4 608             |
| (4) | 4 068 ,           | 4 608 , | 4 680             |

(Go to page 3)

3

3. What fraction of the shapes in the box are  ?

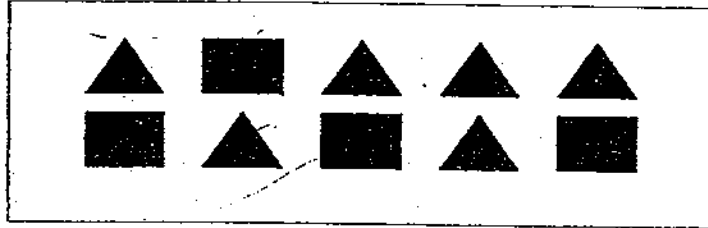

- (1)  $\frac{2}{5}$
- (2)  $\frac{1}{2}$
- (3)  $\frac{3}{5}$
- (4)  $\frac{3}{4}$
4. Find the value of  $\frac{5}{12} - \frac{1}{4}$

- (1)  $\frac{1}{3}$
- (2)  $\frac{1}{4}$
- (3)  $\frac{1}{6}$
- (4)  $\frac{1}{12}$

(Go to page 4)

5. The digit 5 in 4.659 stands for 5 \_\_\_\_\_.
- (1) tens
  - (2) tenths
  - (3) hundreds
  - (4) hundredths
6. Express 0.05 as a fraction in its simplest form.
- (1)  $\frac{1}{2}$
  - (2)  $\frac{1}{5}$
  - (3)  $\frac{1}{20}$
  - (4)  $\frac{1}{25}$
7. What is the best estimate for the product of 949 and 47?
- (1)  $900 \times 40$
  - (2)  $900 \times 50$
  - (3)  $1\ 000 \times 40$
  - (4)  $1\ 000 \times 50$

(Go to page 5)

The graph below shows the number of people in a cinema in the morning on a weekday. Each adult ticket costs \$9 while each child ticket costs \$6.

Study the graph carefully and answer questions 8 and 9.

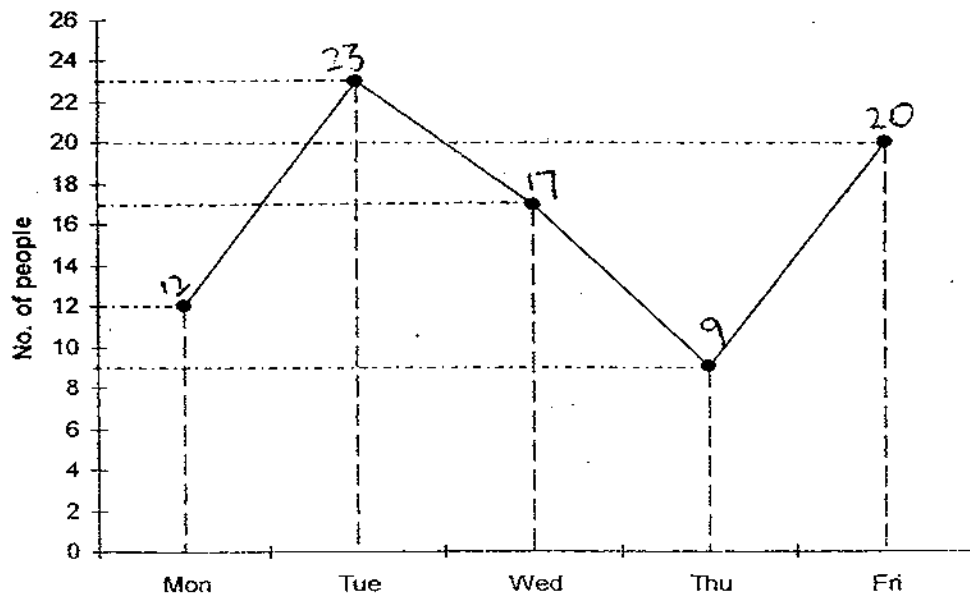

8. How many people went to the cinema from Monday to Wednesday?
- (1) 35  
 (2) 52  
 (3) 61  
 (4) 81
9. Of the people who were at the cinema on Thursday and Friday, 12 of them were adults and the rest were children. How much was collected from the sale of cinema tickets for both days?
- (1) \$102  
 (2) \$108  
 (3) \$210  
 (4) \$225

6

For questions 10 and 11, refer to the figure below.

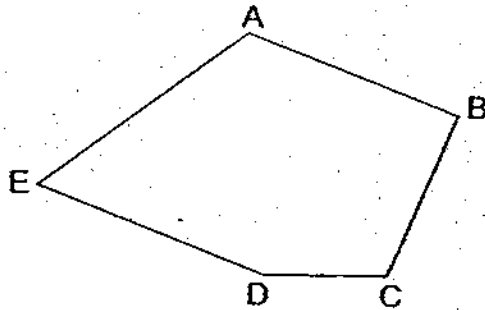

10. Which 2 lines are perpendicular?
- (1) AB and BC
  - (2) AB and ED
  - (3) AE and ED
  - (4) AE and BC
11. Which 2 lines are parallel to each other?
- (1) AB and BC
  - (2) AB and ED
  - (3) AE and ED
  - (4) AE and BC
12. How many seconds are there in  $3\frac{1}{4}$  minutes?
- (1) 195 s
  - (2) 205 s
  - (3) 315 s
  - (4) 325 s

(Go to page 7)

13. How many lines of symmetry does the figure below have?

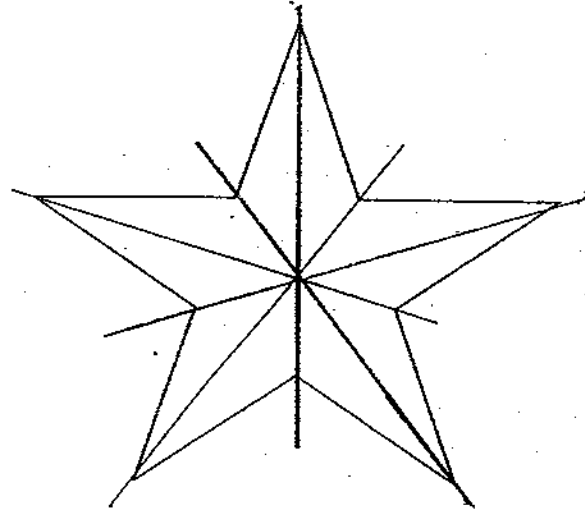

- (1) 1
- (2) 2
- (3) 5
- (4) 0

(Go to page 8)

14. Ben had some hexagons. He glued three hexagons together to form four different patterns as shown below. Taking each pattern as a unit shape, which of the following patterns cannot tessellate?

(1)

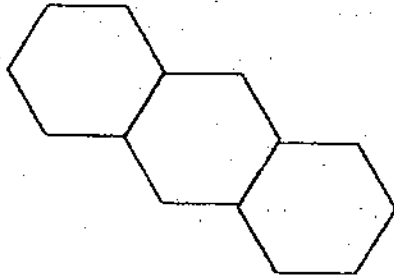

(2)

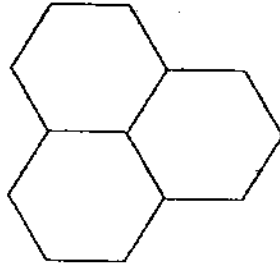

(3)

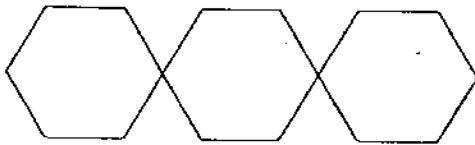

(4)

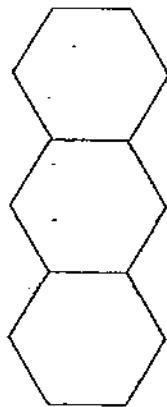



15. I am facing South-East. I make a  $180^\circ$  turn in the clockwise direction, and a  $\frac{1}{4}$ -turn in the anti-clockwise direction.

Where am I facing now?

- (1) North-West
  - (2) North-East
  - (3) South-West
  - (4) South-East
16. The following grid shows the position of the letters, P, Q, R, S, T and U. Each square represents 1 step.

	R					S	
			Q				
						T	
	P						
					U		

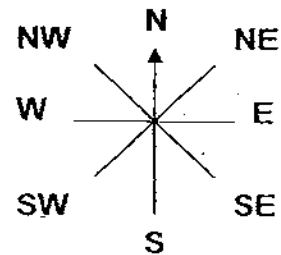

If I move 5 steps West, 2 steps South-East and 2 steps South-West,

I will be at P.

Where was I at the beginning?

- (1) R
- (2) S
- (3) T
- (4) U

10

17. Find the sum of 0.375 and 32.08.

Round off your answer to the nearest hundredth.

- (1) 32.40
- (2) 32.45
- (3) 32.46
- (4) 32.50

18. What is the sum of 3 tens, 17 tenths and 2 hundredths?

- (1) 3.172
- (2) 30.172
- (3) 30.19
- (4) 31.72

19. The area of a square is  $144 \text{ cm}^2$ .  
What is the perimeter of the square?

- (1) 12 cm
- (2) 24 cm
- (3) 36 cm
- (4) 48 cm

(Go to page 11)

20. The figure below is made up of 4 squares A, B, C and D.  
What is the perimeter of the figure?

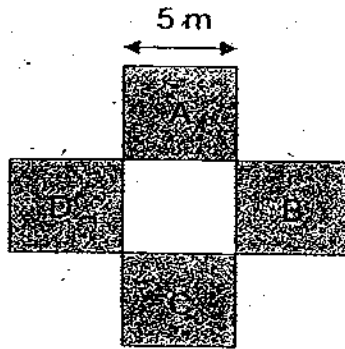

- (1) 60 m
- (2) 80 m
- (3) 100 m
- (4) 125 m

**METHODIST GIRLS' SCHOOL (Primary)**  
**2009 End-of-Year Examination**  
**Primary 4**

**MATHEMATICS**

**BOOKLET B**

Name: \_\_\_\_\_ ( )

Class: P 4. \_\_\_\_\_

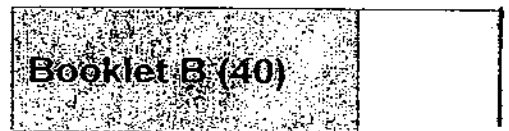

Total time for Booklets A, B and C: 1 h 45 min

---

Do not turn over this page until you are told to do so.

Follow all instructions carefully.

Answer all questions.

This booklet consists of 9 printed pages.

**Section B (40 marks)**

**Write your answers in the space provided.**

**For questions which require units, give your answers in the units stated.**

21. Fill in the blank with the correct number in the number pattern below.

22. What is the first common multiple of 4 and 9?

23. Round off 51 050 to the nearest hundred.

24. Write  $\frac{18}{8}$  as a mixed number in its simplest form.

(Go to page 13)

25. What is the missing number in the box?

$$\frac{2}{3} = \frac{\square}{12}$$

26. Round off 13.54 to the nearest whole number.

27. Write the decimal represented by A.

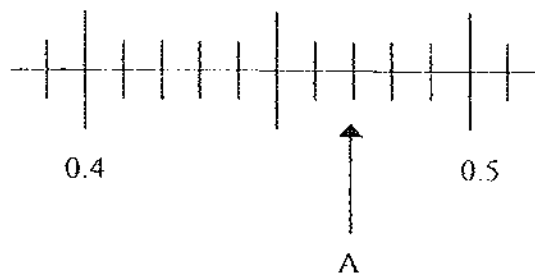

28. In the figure, ABCD is a rectangle. Find the value of  $\angle x$ .

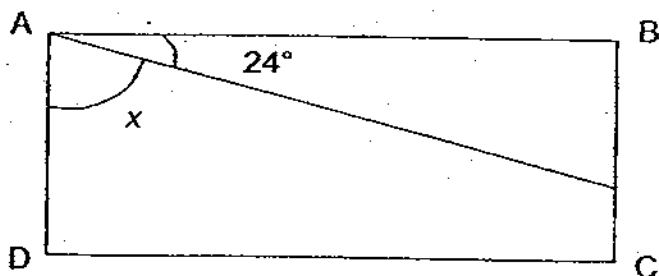

29. Measure and write down the size of  $\angle y$ .

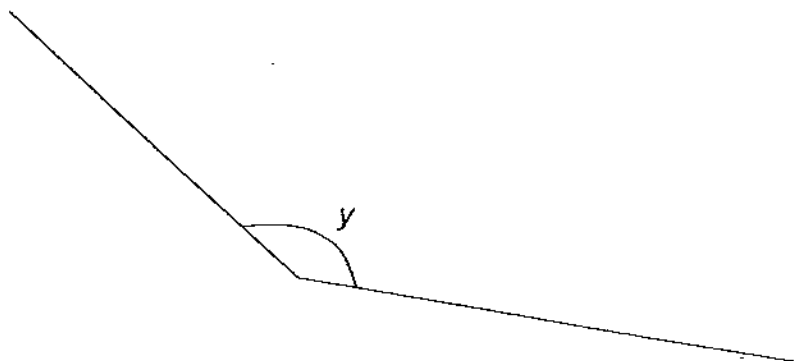

30. Ken watched a show which lasted for 1 hour 55 minutes.  
If the show ended at 17 20, what time did the show start?

(Go to page 15)

31. The flight from Singapore to Tokyo takes 6 hours 50 minutes.  
 Tokyo is one hour ahead of Singapore.  
 If the plane took off from Singapore at 3.30 p.m.,  
 what was the time in Tokyo when the plane landed?



32. In the figure below, the line XY is the line of symmetry.  
 Complete the figure below to make a symmetric pattern.

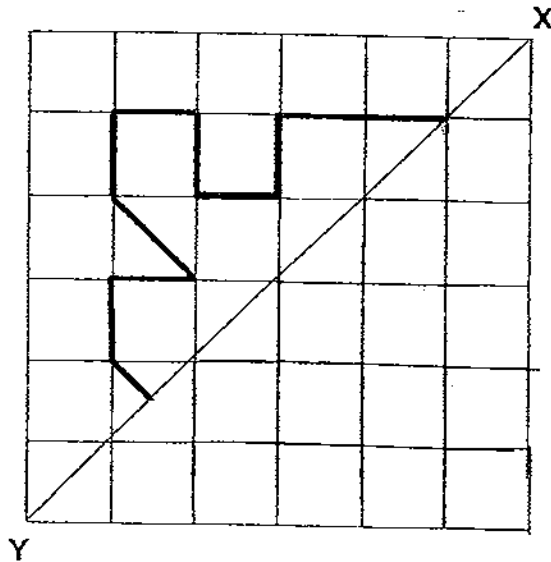

(Go to page 16)



33. Extend the tessellation by 5 more units.

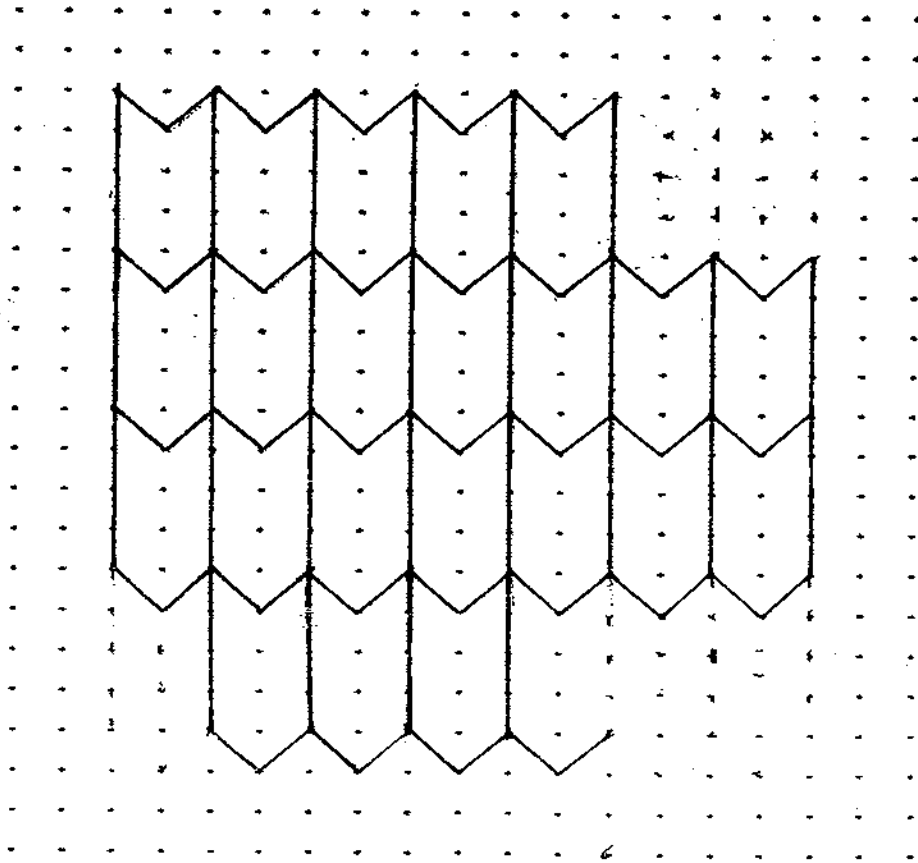

(Go to page 17)

Town X and Town Y are 250 km apart.

The table below shows the distance travelled by 3 cars from Town X to Town Y.

Study it carefully and answer questions 34 and 35.

Car	Distance travelled in km
A	85
B	135
C	210

34. What was the total distance left to be covered by the 3 cars to reach Town Y?

35. If all 3 cars were travelling at the same speed, which car would reach Town Y first?

(Go to page 18)

36. (a) Draw a line BC perpendicular to AB.  
(b) Draw a line CD parallel to AB.

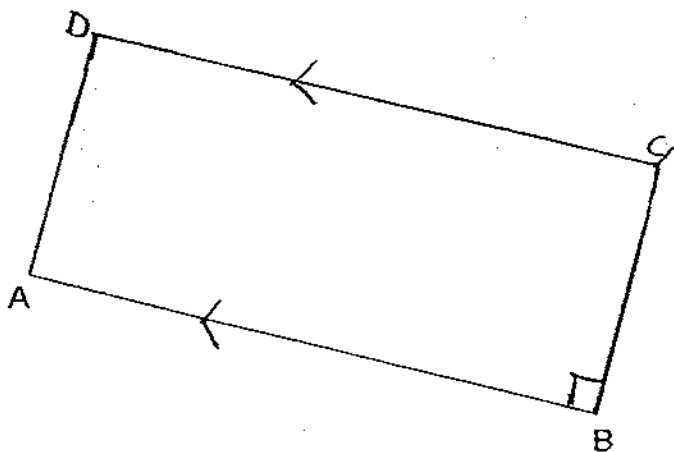

37. (a) Name the 4-sided figure above in Q36.

- (b) Name one other 4-sided figure.

(Go to page 19)

38. How many more squares must be shaded so that  $\frac{3}{4}$  the figure is shaded?

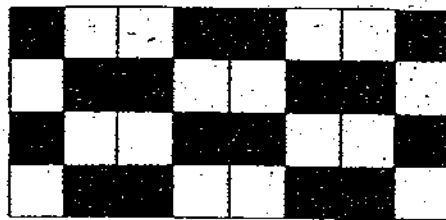

The figure below is made up of a square and 2 rectangles. Study it carefully and answer questions 39 and 40.

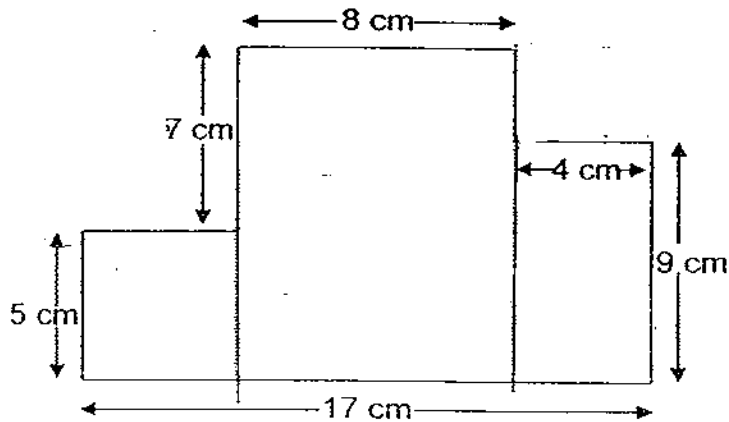

39. Find the perimeter of the figure.

40. Find the area of the figure.

(Go to page 20)

**METHODIST GIRLS' SCHOOL (Primary)**  
**2009 End-of-Year Examination**  
**Primary 4**

# **MATHEMATICS**

## **BOOKLET C**

Name \_\_\_\_\_ ( )

Class: P 4 \_\_\_\_\_

Total time for Booklets A, B and C: 1 h 45 min

<b>Booklet A (40)</b>	
<b>Booklet B (40)</b>	
<b>Booklet C (20)</b>	
<b>Total (100)</b>	

---

Do not turn over this page until you are told to do so.

Follow all instructions carefully.

Answer all questions.

Show your working clearly as marks are awarded for correct working.

Write your answers in this booklet.

This booklet consists of 4 printed pages.

**Section C (20 marks)**

Show your working clearly in the space provided for each question and write your answers in the space provided.

The number of marks available is shown in brackets [ ] at the end of each question or part-question.

41. Anne had \$165 and Cally had \$200 at first.  
After spending an equal amount of money, Cally had twice as much money as Anne.  
How much money did each of them spend?

Ans: \_\_\_\_\_ [ 4 ]

42. A box contained 282 black and white beads.  
After 36 of the black beads were taken out and 58 white beads were added, there is an equal number of black and white beads in the box.  
How many white beads were there in the box at first?

Ans: \_\_\_\_\_ [ 4 ]

(Go to page 21)

43. 23 books are put one on top of the other.  
6 of them have a thickness of 1.6 cm each, 9 of them have a thickness of 2.4 cm each and the rest are of the same thickness each.  
If the height of the pile of books is 43.28 cm,  
what is the thickness of each of the remaining books?

Ans: \_\_\_\_\_ [4]

44. Sam has \$250. Peter has  $\frac{2}{5}$  of what Sam has while John has  $\frac{3}{4}$  of what Peter has. How much money do they have altogether?

Ans \_\_\_\_\_ [4]

(Go to page 22)

45. Mr Lim has a rectangular garden as shown in the figure below.
- (a) What is the length of fence needed to fence his garden?
- (b) He removed the grass at the 4 corners of his garden in order to build one fountain at each corner. What area of the garden is now covered with grass?

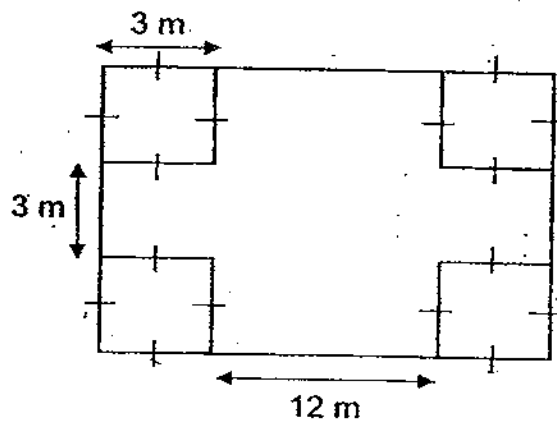

Ans: (a) \_\_\_\_\_ [2]

(b) \_\_\_\_\_ [2]





# ANSWER SHEET

## EXAM PAPER 2009

SCHOOL : MGS PRIMARY  
 SUBJECT : PRIMARY 4 MATHEMATICS

TERM : SA2

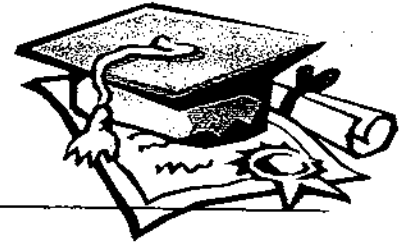

Q1	Q2	Q3	Q4	Q5	Q6	Q7	Q8	Q9	Q10	Q11	Q12	Q13	Q14	Q15	Q16	Q17
4	4	3	3	4	3	2	2	3	1	2	1	3	3	3	2	3

Q18	Q19	Q20
4	4	2

- 21)101    22)36    23)51100    24) $2\frac{1}{4}$     25)8    26)14    27)0.47  
 28) $66^\circ$     29) $147^\circ$     30)1525    31)11.20p.m.    32)

33)

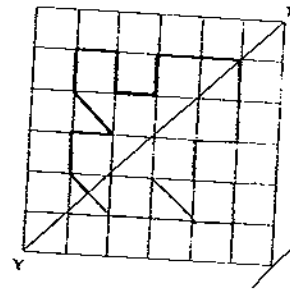
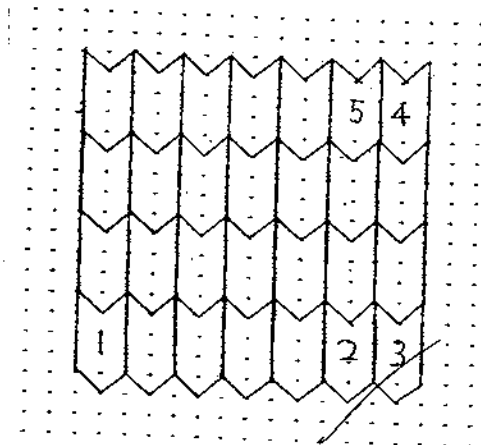

- 34)320km    35)C    36)a,b

- 37)a)Rectangle  
 b)Square

**38)8**

**39)58cm**

**40)157cm<sup>2</sup>**

**41)\$135**

**42)94**

**43)1.51**

**44)\$425**

**45)a)54m**

**b)126m<sup>2</sup>**