

5



PEI HWA PRESBYTERIAN PRIMARY SCHOOL  
SEMESTRAL ASSESSMENT 2

PRIMARY 4  
MATHEMATICS PAPER

25 OCT 2016

Name: \_\_\_\_\_

Form Class / Register No. : 4TW \_\_\_\_\_ / \_\_\_\_\_

Banded Class / Register No. : 4M \_\_\_\_\_ / \_\_\_\_\_

Total time: 1 h 45 min

**INSTRUCTIONS TO CANDIDATES**

1. Write your Name, Class and Register No. in the spaces provided above.
2. DO NOT turn over this page until you are told to do so.
3. Follow all instructions carefully.
4. Answer all questions.
5. For Section A, shade your answers on the Optical Answer Sheet (OAS) provided.
6. For Section B and C, write all your answers in this booklet
7. The use of calculator is **NOT ALLOWED**.

Total Marks :

100

This booklet consists of 16 printed pages, excluding the cover page.

**Section A: Multiple Choice Questions (20×2 = 40 marks)**

For each question, four options are given. One of them is the correct answer. Make your choice (1, 2, 3 or 4). Shade the oval (1, 2, 3 or 4) on the Optical Answer Sheet.

1 What is the missing number in the box?

$$97\ 165 = 90\ 000 + 7000 + \boxed{\phantom{000}} + 5$$

- (1) 165
- (2) 160
- (3) 60
- (4) 16

( )

2 In which of the following are the numbers arranged from the smallest to the greatest?

(smallest) (greatest)

- (1) 5078 , 5708 , 5780
- (2) 5780 , 5708 , 5078
- (3) 5078 , 5780 , 5708
- (4) 5780 , 5078 , 5708

( )

3 Which of the following has  $\frac{1}{5}$  of the figure shaded?



(1)

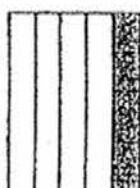

(2)



(3)

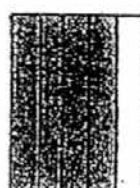

(4)

( )

4 Write  $4\frac{7}{20}$  as a decimal.

- (1) 4.035
- (2) 4.35
- (3) 4.7
- (4) 4.72

( )

5 What is the missing number in the box?

$$9.02 = 9 + \frac{2}{\square}$$

- (1) 1
- (2) 10
- (3) 100
- (4) 1000

( )

6 Which of the following mixed numbers is represented by the letter A in the number line shown?

- (1)  $7\frac{1}{5}$
- (2)  $7\frac{4}{5}$
- (3)  $8\frac{1}{5}$
- (4)  $8\frac{4}{5}$

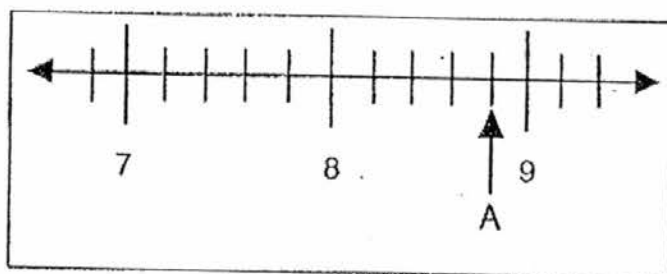

( )

7 Which of the following is multiple of 9?

- (1) 19
- (2) 27
- (3) 3
- (4) 46

( )

8 In the figure below, which one of the following is a  $\frac{3}{4}$ -turn?

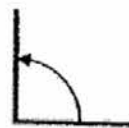
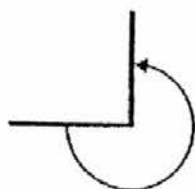
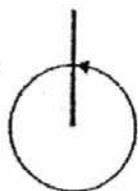

(1)

(2)

(3)

(4)

( )

9 In the figure below, which angle is a right angle?

- (1)  $\angle a$
- (2)  $\angle b$
- (3)  $\angle c$
- (4)  $\angle d$

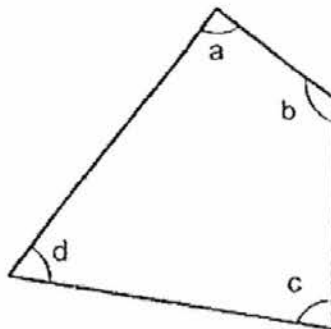

( )

10 A wire is used to make a rectangle as shown below. What is the length of the wire?

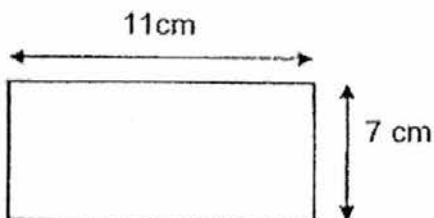

- (1) 4 cm
- (2) 18 cm
- (3) 36 cm
- (4) 77 cm

( )

11 In the figure below, MNOP is a square. Find  $\angle c$ .

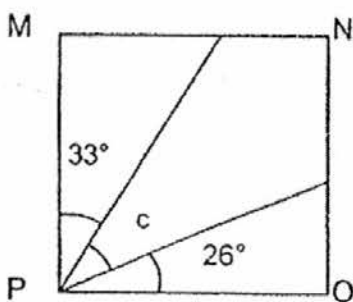

- (1)  $31^\circ$
- (2)  $57^\circ$
- (3)  $59^\circ$
- (4)  $64^\circ$

( )

12 Which of the following is the greatest?

(1)  $3\frac{1}{2}$

(2)  $2\frac{5}{3}$

(3)  $\frac{13}{3}$

(4) 4

( )

13 After turning  $225^\circ$  in an anti-clockwise direction, Jeremy faced the North direction. Which direction was Jeremy facing before the turn?

(1) East

(2) North-west

(3) South-east

(4) South-west

( )

14 If 1 kg of chicken costs \$5, how much does the chicken in the figure below cost?

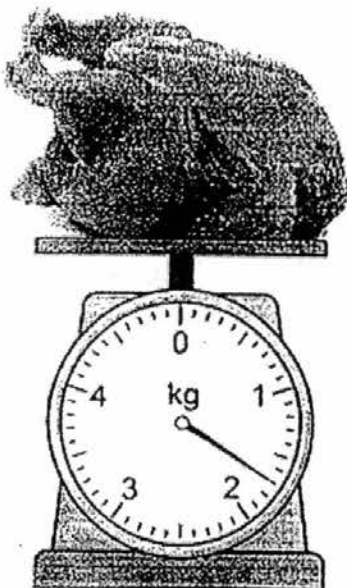

(1) \$1.70

(2) \$6.00

(3) \$8.50

(4) \$11.50

( )

- 15 Square A and rectangle B have the same area.  
What is the length of square A?

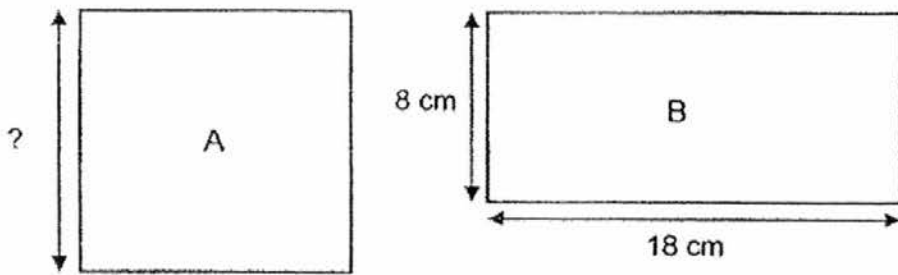

- (1) 10 cm  
(2) 12 cm  
(3) 54 cm  
(4) 144 cm ( )
- 16 Sherry cooked 150 fish nuggets. If she only sells them in boxes of 8, how many boxes of fish nuggets can she sell?
- (1) 6  
(2) 18  
(3) 19  
(4) 1200 ( )
- 17 If you subtract 3.62 from a number and multiply the result by 5, you will get 35. What is the number at first?
- (1) 3.38  
(2) 7  
(3) 10.62  
(4) 18.1 ( )
- 18 A movie started at 21 50 and ended at 23 05. How long did the movie last?
- (1) 1 h 15 min  
(2) 1 h 55 min  
(3) 2 h 15 min  
(4) 2 h 55 min ( )

19 Which one of these letters has no line of symmetry?

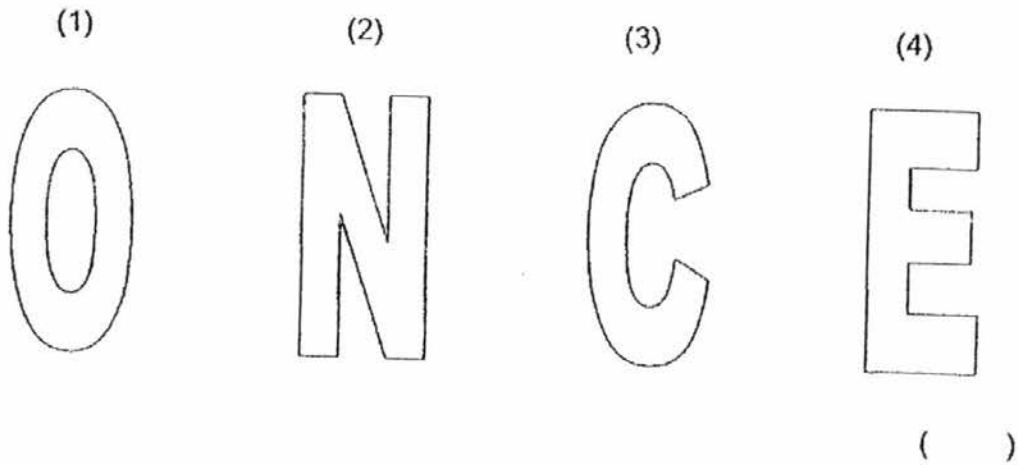

20 The bar graph below shows the number of goals scored by Players A to E. What is the difference between the number of goals scored by Player A and Player C?

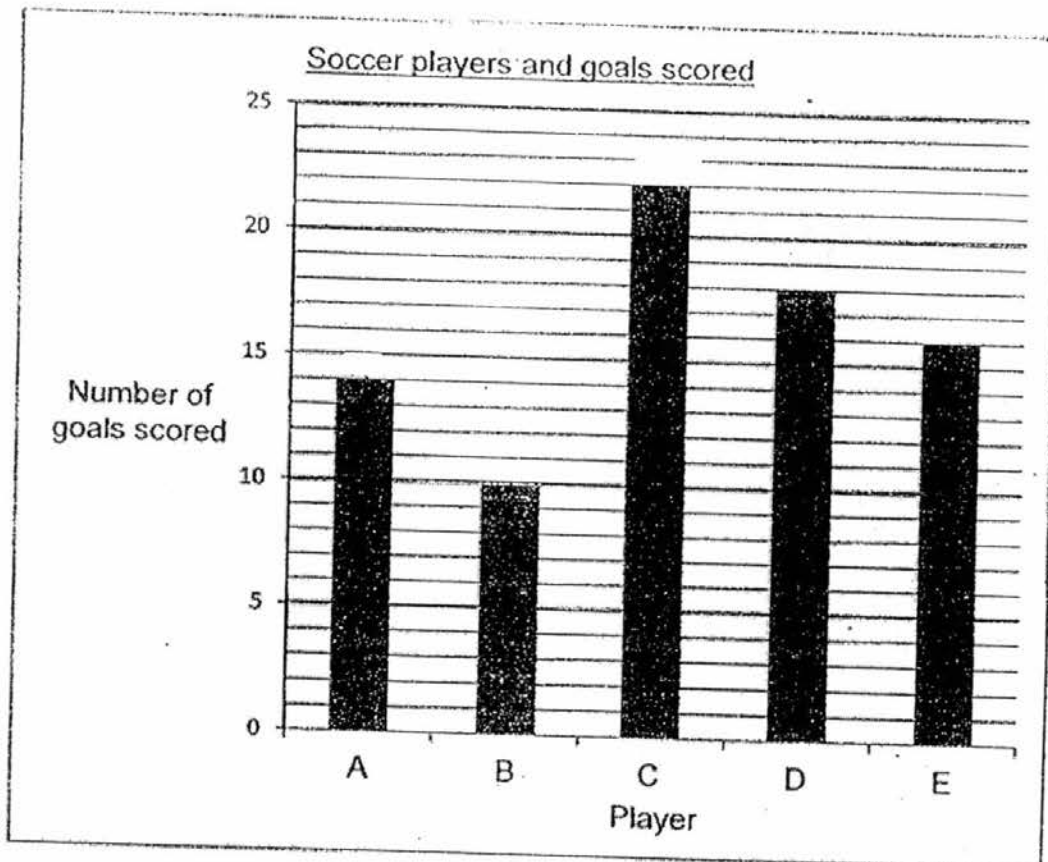

- (1) 6  
(2) 8  
(3) 14  
(4) 36

( )

**Section B (20 × 2 = 40 marks)**

Write your answers in the answer blanks provided.

For questions that require working, show your working clearly in the space provided.

---

21 Subtract 587 from 955.

Ans: \_\_\_\_\_

22 Some factors of 36 are 1, 2, 3, 6, 9, 12 and 36.  
What are the other 2 factors of 36?

Ans: \_\_\_\_\_ and \_\_\_\_\_

23 Find the product of 1336 and 8.

Ans: \_\_\_\_\_

24 Express  $\frac{8}{12}$  in its simplest form.

Ans: \_\_\_\_\_

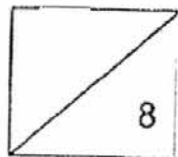



25  $\frac{5}{8} - \frac{1}{2} =$  \_\_\_\_\_

Ans: \_\_\_\_\_

26 Arrange the following numbers from the smallest to the greatest.

0.809 , 0.098 ,  $\frac{4}{5}$

Ans: \_\_\_\_\_ , \_\_\_\_\_ , \_\_\_\_\_  
(smallest) (greatest)

27 Roger bought 14 chairs at \$37 each. How much did he spend on all the chairs?

Ans: \$ \_\_\_\_\_

28 Round off 24.48 to the nearest whole number.

Ans: \_\_\_\_\_

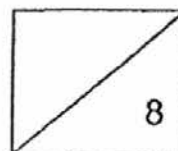

- 29 Measure and write down the size of  $\angle x$ .

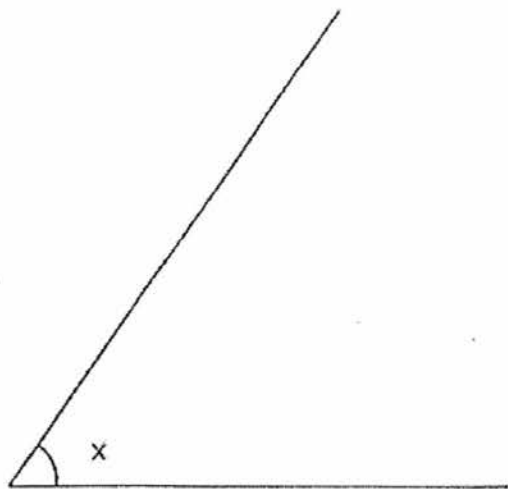

Ans: \_\_\_\_\_<sup>o</sup>

- 30 The figure below is made up of three identical rectangles. The figure has a perimeter of 30 cm. Find the area of the figure.

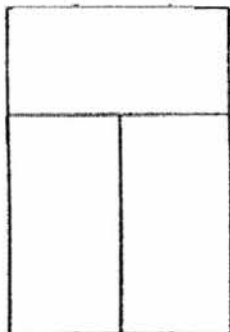

Ans: \_\_\_\_\_ cm<sup>2</sup>

- 31 The figure below is made up of two identical overlapping rectangles ABCD and PQRS. Find the perimeter of the figure.

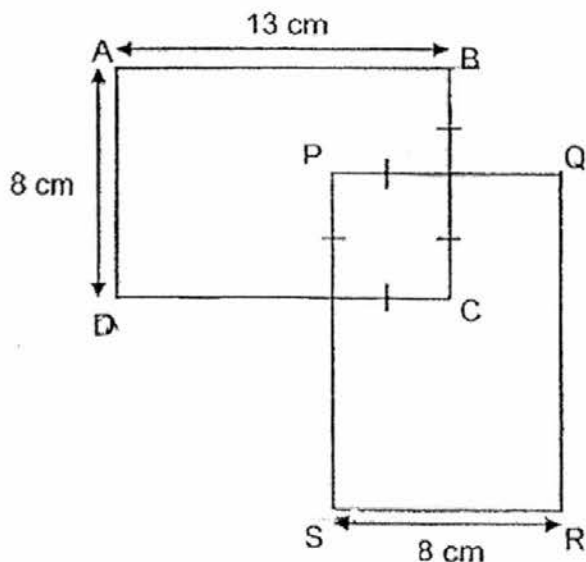

Ans: \_\_\_\_\_ cm

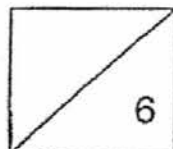

- 32 The figure below shows a soccer field, 80 m by 40 m with a path, 10 m wide around it. Find the area of the path.

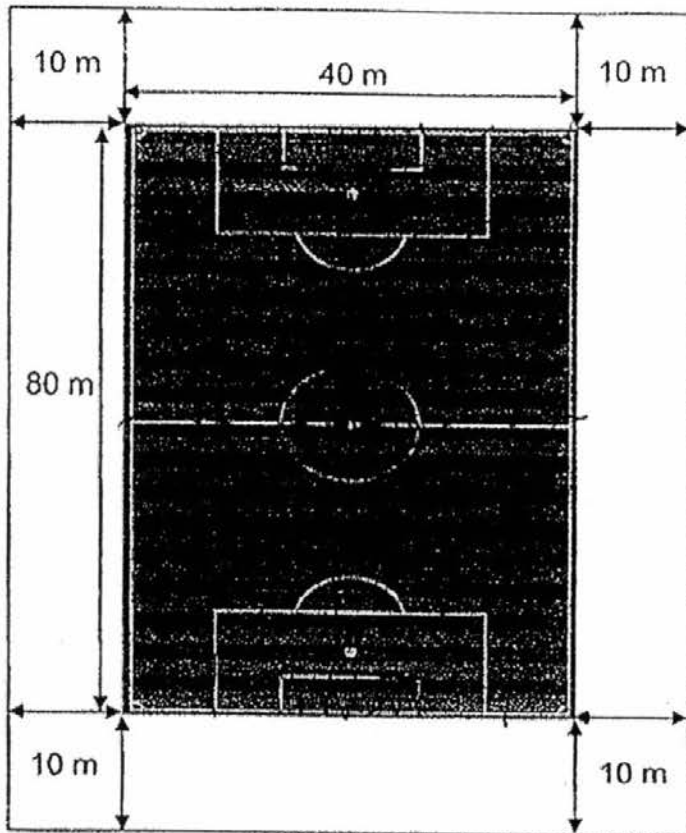

Ans: \_\_\_\_\_ m<sup>2</sup>

- 33 Find the value of  $6.84 \times 7$ .

Ans: \_\_\_\_\_ cm

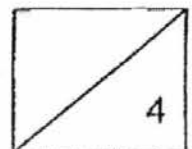

- 34 The mass of a packet of rice was 3.2 kg. Mdm Haryati used 0.55 kg of rice on first day and the same mass was used on the second day. How much rice was left?

Ans: \_\_\_\_\_ kg

- 35 In a long jump competition, Shanti jumped 3.57 m. Ravin jumped 0.23 m further than Shanti. What is their total distance jumped?

Ans: \_\_\_\_\_ m

- 36 Complete the symmetric figure with line AB as the line of symmetry.

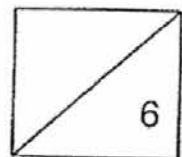
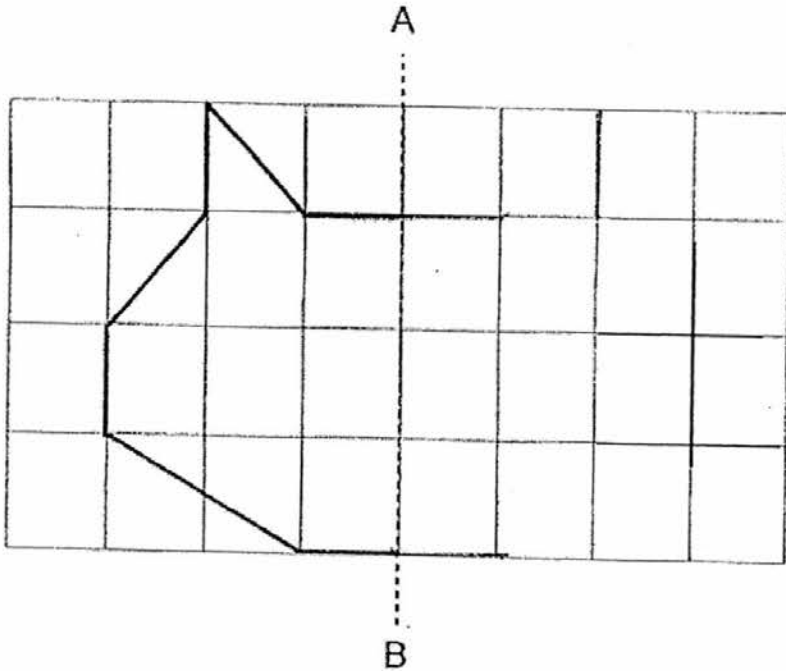

- 37 The line graph below shows Jasmine's heart rate over a 30-minute duration of exercise.

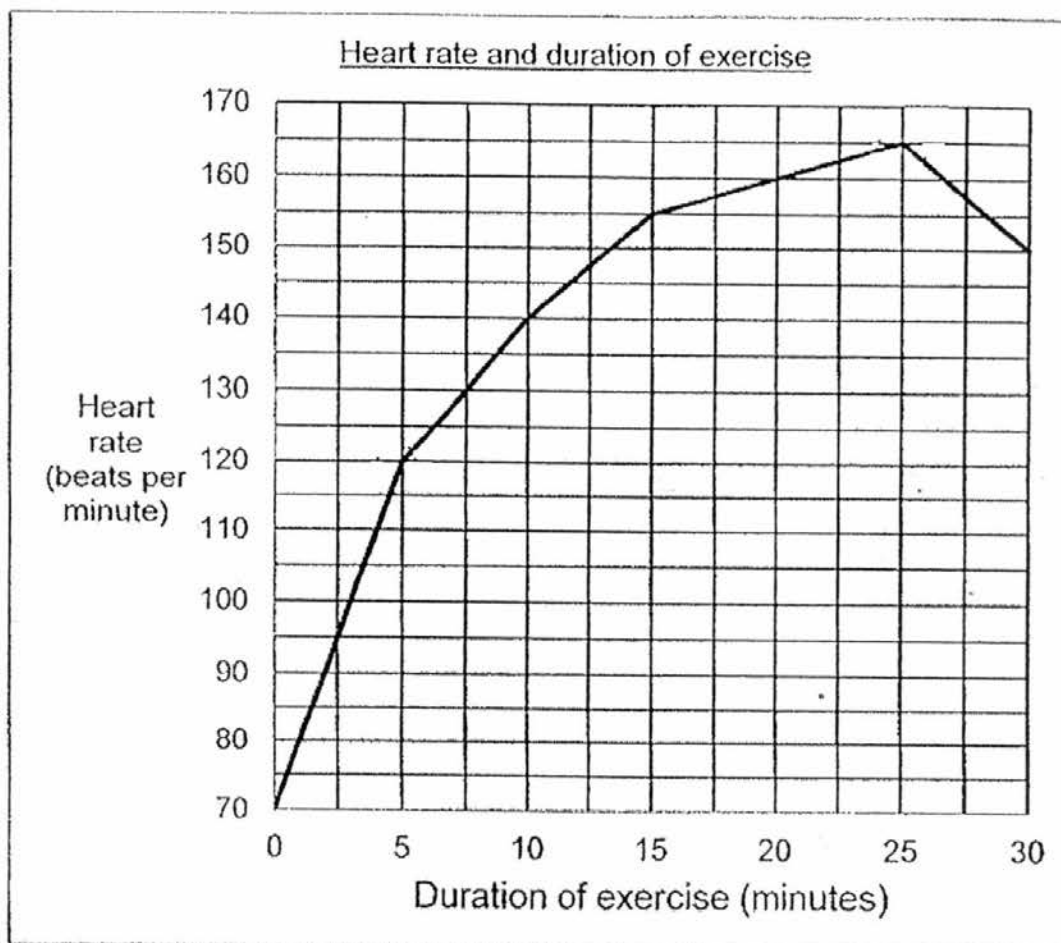

Use the line graph above to fill in the table below.

Duration of exercise (minutes)	0	5	10	15	20	25	30
Heart rate (beats per minute)	70		140	155	160		150

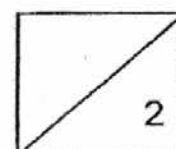

- 38 Singapore time is 7 h ahead of London time. A plane took off from Singapore at 05 00 and flew to London. When it landed in London, the clock there showed 11 00. How long did the flight take?

Ans: \_\_\_\_\_

- 39 A bottle contained  $\frac{7}{8}$  l of orange juice. Jody drank  $\frac{3}{4}$  l of orange juice from the bottle. How much orange juice was left in the bottle?

Ans: \_\_\_\_\_

- 40 Faizal took 30 minutes to run from home to the park. He spent 55 minutes at the park. Then, he took 25 minutes to run back home. If he left home at 8 a.m. for his run, at what time did he reach home?

Ans: \_\_\_\_\_

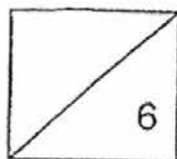

**Section C (5 × 4 = 20 marks)**

Solve each of the following problems. Show all your working and statements clearly. Write your answers in the spaces provided.

- 41 Ahmad and Bala had a total of 96 erasers. After giving away 12 erasers each, Ahmad had 3 times as many erasers as Bala. How many erasers does Bala have at first?

Working

Ans: \_\_\_\_\_

- 42 During an exhibition, an adult ticket cost \$5 and a child ticket costs \$2. On a particular day, the exhibition sold 689 more children tickets than adult tickets. A total of \$2505 was collected. How many adult tickets were sold?

Ans: \_\_\_\_\_

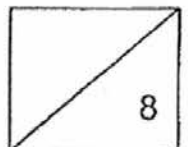

- 43 Rena bought some items at a grocery store.  $\frac{2}{3}$  of them were apples,  $\frac{1}{9}$  of them were bananas and the rest were lemons. She bought 12 more apples than lemons.

How many lemons did Rena buy?

Ans: \_\_\_\_\_

- 44 Shawn spent \$36.40 over 4 days. He spent \$2.60 more each day than the day before. How much did Shawn spend on the first day?

Ans: \_\_\_\_\_

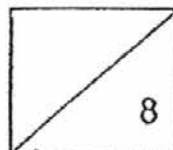



- 45 The figure below is made up of A, B, C and D and has a perimeter of 68 cm. A and B are squares while C and D are rectangles. Square A has an area of  $121 \text{ cm}^2$ . Find the area of rectangle D.

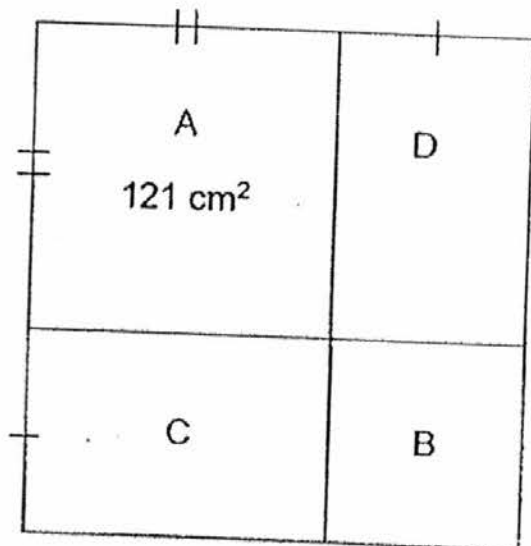

Working

Ans: \_\_\_\_\_

- End of Paper -

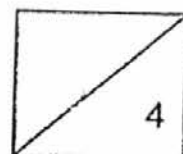

EXAM PAPER 2016 (P4)

SCHOOL : PEI HWA

SUBJECT : MATHEMATICS

TERM : SA2

Q1	Q2	Q3	Q4	Q5	Q6	Q7	Q8	Q9	Q10
2	1	2	2	3	4	2	2	1	3
Q11	Q12	Q13	Q14	Q15	Q16	Q17	Q18	Q19	Q20
1	3	4	3	2	2	3	1	2	2

21)368      22)18 and 4      23)10688      24) $\frac{2}{3}$       25) $\frac{1}{8}$

26)0.098,  $\frac{4}{5}$ , 0.809      27)\$518      28) $24^\circ$       29) $55^\circ$

30) $30 \div 10 = 3$

$$3 \times 3 = 9$$

$$3 \times 2 = 6$$

$$6 \times 9 = 54\text{cm}^2$$

31) $8 \div 2 = 4$

$$13 - 4 = 9$$

$$8 - 4 = 4$$

$$17 \times 4 = 68\text{cm}$$

32)  $80 \times 40 = 3200\text{m}^2$

$100 \times 60 = 6000$

$6000 - 3200 = 2800\text{m}^2$

33)  $6.84 \times 7 = 47.88$

34)  $0.55 \times 2 = 1.10$

$3.20 - 1.10 = 2.10\text{kg}$

35)  $3.57 + 0.23 = 3.80$

$3.80 + 3.57 = 7.37\text{m}$

36)

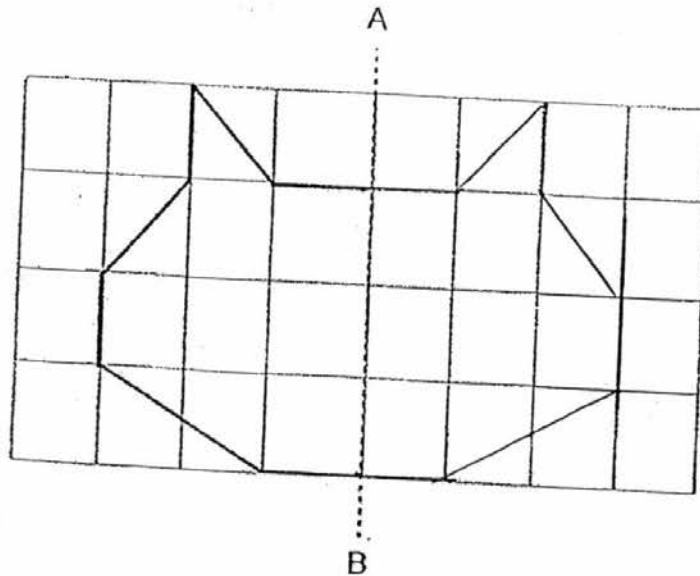

37)  $120 / 165$

38) 13 hours

39)  $\frac{3}{4} = \frac{6}{8}$

$\frac{7}{8} - \frac{6}{8} = \frac{1}{8}\text{L}$

40) 9.50 a.m.

$$41) 12 \times 2 = 24$$

$$96 - 24 = 72$$

$$72 \div 4 = 18$$

$$1u \rightarrow 18$$

$$18 + 12 = 30$$

Bala has 30 erasers at first.

$$42) 689 \times 2 = 1378$$

$$2505 - 1378 = 1127$$

$$2 + 5 = 7$$

$$1127 \div 7 = 161$$

161 adult tickers were sold.

$$43) 12 \div 4 = 3$$

$$1u \rightarrow 3$$

$$3 \times 2 = 6$$

Rena bought 6 lemons.

$$44) 2.60 \times 6 = 15.60$$

$$36.40 - 15.60 = 20.80$$

$$20.80 \div 4 = \$5.20$$

Shawn spend \$5.20 on the first day.

$$45) 11 \times 11 = 121$$

$$68 \div 4 = 17$$

$$17 - 11 = 6$$

$$11 \times 6 = 66\text{cm}^2$$

The area of rectangle D is  $66\text{cm}^2$