



PEI HWA PRESBYTERIAN PRIMARY SCHOOL  
SEMESTRAL ASSESSMENT 2

PRIMARY 4  
MATHEMATICS PAPER

27 OCT 2017

Name: \_\_\_\_\_

Form Class / Register No. : 4TW \_\_\_\_\_ / \_\_\_\_\_

~~Banded Class / Register No. : 4M \_\_\_\_\_ / \_\_\_\_\_~~

Total time: 1 h 45 min

**INSTRUCTIONS TO CANDIDATES**

1. Write your Name, Class and Register No. in the spaces provided above.
2. DO NOT turn over this page until you are told to do so.
3. Follow all instructions carefully and answer all questions.
4. For Section A, shade your answers on the Optical Answer Sheet (OAS) provided.
5. For Section B and C, write all your answers in this booklet
6. The use of calculator is **NOT ALLOWED**.

Marks (Section A) :	40
Marks (Section B) :	40
Marks (Section C) :	20
Total Marks:	100

This booklet consists of 22 printed pages, excluding the cover page.

**Section A: Multiple Choice Questions (20×2 = 40 marks)**

For each question, four options are given. One of them is the correct answer. Make your choice (1, 2, 3 or 4). Shade the oval (1, 2, 3 or 4) on the Optical Answer Sheet.

---

1 55 thousands and 7 tens is the same as \_\_\_\_\_.

- (1) 557
- (2) 5570
- (3) 55 007
- (4) 55 070

( )

2 How many one-sixths are there in 5 wholes?

- (1)  $1\frac{1}{5}$
- (2)  $\frac{5}{6}$
- (3) 6
- (4) 30

( )

3 Which of the following is not an equivalent fraction of  $\frac{4}{5}$ ?

- (1)  $\frac{2}{10}$
- (2)  $\frac{8}{10}$
- (3)  $\frac{12}{15}$
- (4)  $\frac{16}{20}$

( )

4 What fraction of the shapes in the box are  ?

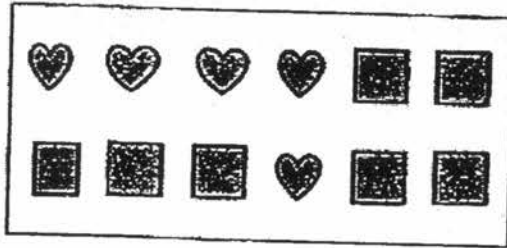

(1)  $\frac{5}{12}$

(2)  $\frac{5}{7}$

(3)  $\frac{7}{12}$

(4)  $\frac{7}{5}$

( )

5 Express  $\frac{34}{100}$  as a decimal.

(1) 0.304

(2) 0.034

(3) 0.34

(4) 3.04

( )

6 Arrange the following decimals from the smallest to the greatest.

8.1 , 0.81 , 8.01 , 0.18

(1) 0.18, 0.81, 8.01, 8.1

(2) 0.81, 0.18, 8.01, 8.1

(3) 0.18, 8.1, 8.01, 0.81

(4) 0.81, 0.18, 8.1, 8.01

( )

7 The top half of a symmetric figure is shown below.

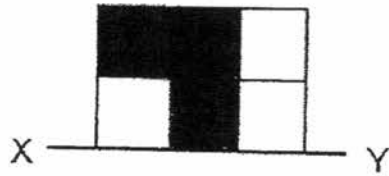

Given that XY is the line of symmetry, which one of the following completes the symmetric figure?

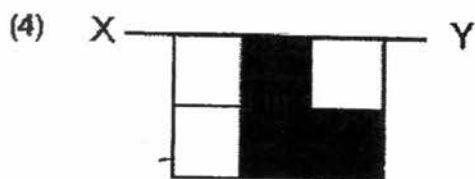
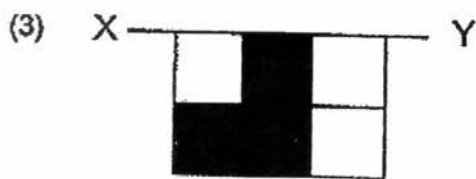
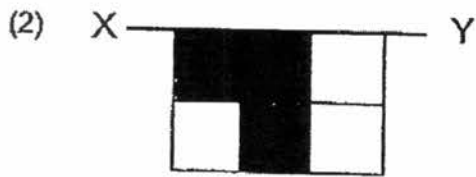
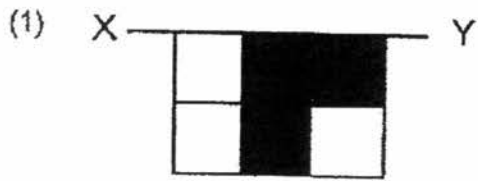

( )

- 8 Tony wants to estimate the answer for  $257 + 8$ .  
Which one of the following is the best estimation?

- (1)  $240 + 8$
- (2)  $240 + 10$
- (3)  $260 + 10$
- (4)  $300 + 8$

( )

- 9 Which is the best estimate for the size of  $\angle TUV$ ?

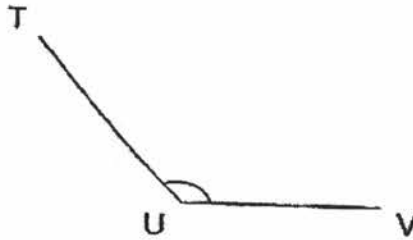

- (1)  $45^\circ$
- (2)  $90^\circ$
- (3)  $135^\circ$
- (4)  $180^\circ$

( )

- 10 What is the sum of the fourth and sixth multiples of 5?

- (1) 10
- (2) 20
- (3) 30
- (4) 50

( )

11 What is the sum of the values of the digit 6 in 18.36 and 3.607?

- (1) 0.6
- (2) 0.06
- (3) 0.66
- (4) 0.066

( )

12 Which one of the following numbers when added to 39 364 will give an even digit in the thousands place?

- (1) 2415
- (2) 4815
- (3) 6615
- (4) 8015

( )

13 Amanda was standing at Point X facing East. She made a  $\frac{1}{2}$ -turn. She would then be facing \_\_\_\_\_.

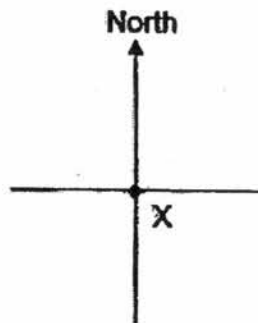

- (1) East
- (2) North
- (3) South
- (4) West

( )

- 14 In the figure below, PQRS is a rectangle.  $\angle UST = \angle TSR$  and  $\angle PSU = 52^\circ$ . Find the value of  $\angle UST$ .

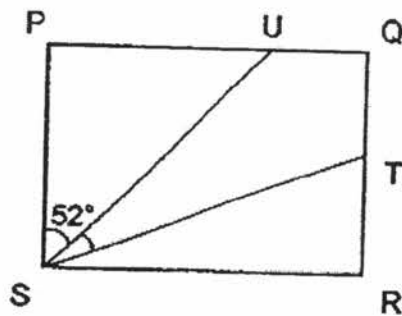

- (1)  $19^\circ$
- (2)  $38^\circ$
- (3)  $64^\circ$
- (4)  $128^\circ$

( )

- 15 The figure below is a rectangle with a breadth of 4 cm. Its length is 3 times its breadth. Find the perimeter of the rectangle.

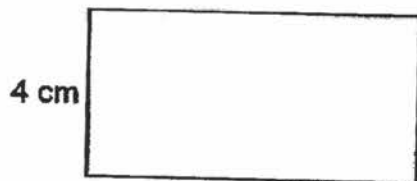

- (1) 12 cm
- (2) 16 cm
- (3) 32 cm
- (4) 48 cm

( )

- 16 Arielle's teacher started her piano lesson 35 minutes late.  
The lesson lasted for 1 hour and 15 minutes and ended at 2.45 p.m.  
What time was her lesson supposed to start?

- (1) 1.30 p.m.
- (2) 2.05 p.m.
- (3) 2.10 p.m.
- (4) 12.55 p.m.

( )

- 17 Michelle has 3 times as many marbles as Nelly.  
Olivia has 35 more marbles than Michelle.  
If Michelle and Nelly have 560 marbles altogether, how many marbles does Olivia have?

- (1) 260
- (2) 385
- (3) 420
- (4) 455



18 The graph below shows the time taken by 4 pupils for their 100-m run.

Time taken (seconds)

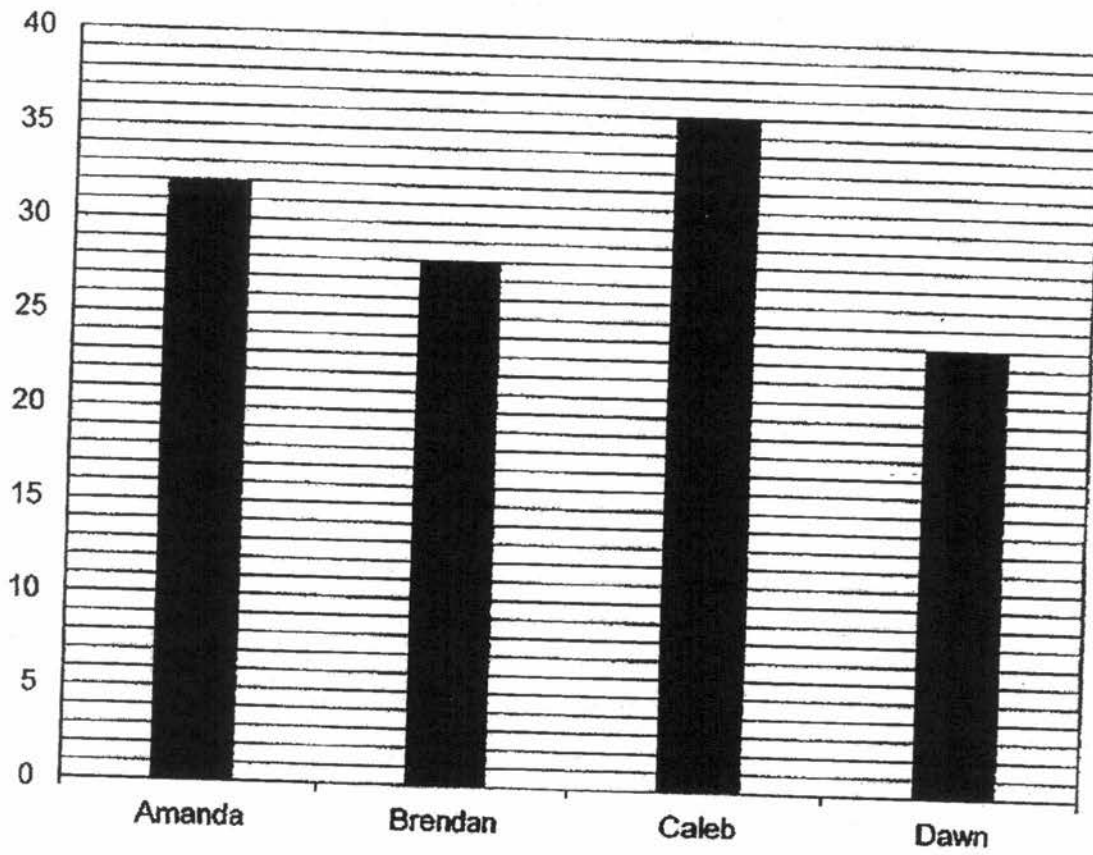

Who is the fastest pupil?

- (1) Amanda
- (2) Brendan
- (3) Caleb
- (4) Dawn

( )

- 19 U, O and V are three cities on a map. U is north of O and  $\angle UOV$  is  $45^\circ$ .  
In what direction is V from O?

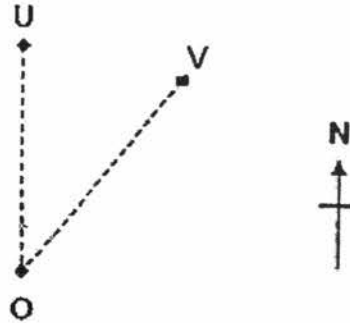

- (1) North-East  
(2) North-West  
(3) South-East  
(4) South-West
- ( )
- 20 Stall A sells cherries at \$2.80 for every 200 g.  
Stall B sells the same amount of cherries at \$0.90 less than Stall A.  
How much will Mrs Fong save if she buys 0.8 kg of cherries from Stall B instead?

- (1) \$3.60  
(2) \$7.20  
(3) \$7.60  
(4) \$11.20
- ( )

**Section B (20 × 2 = 40 marks)**

Write your answers in the answer blanks provided.

For questions that require working, show your working clearly in the space provided.

21  $98\ 403 = 90\ 000 + 8\ 000 + \underline{\quad ? \quad} + 3$

What is the missing number?

Ans: \_\_\_\_\_

22 What is the remainder when 4324 is divided by 6?

Ans: \_\_\_\_\_

23 In the figure below, name the smallest angle.

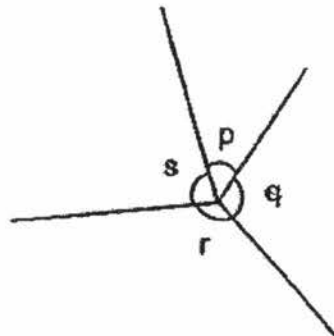

Ans:  $\angle$  \_\_\_\_\_

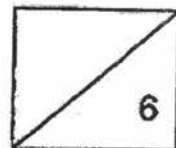

- 24 In the figure below, ABCD is a square.  
Find  $\angle x$ .

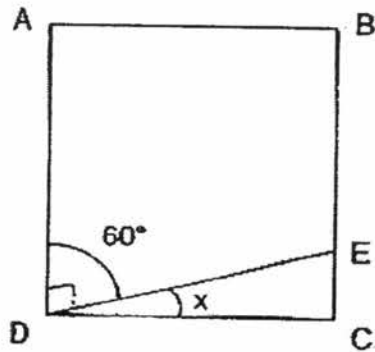

Ans: \_\_\_\_\_°

- 25 What is the value of  $\frac{5}{8} + \frac{2}{4}$ ?  
Express your answer as a mixed number.

Ans: \_\_\_\_\_

- 26 Round 18.55 to the nearest whole number.

Ans: \_\_\_\_\_

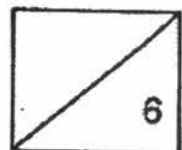

27 Express 0.7 as a fraction.

Ans: \_\_\_\_\_

28 Find the value of  $7.39 \times 6$ .

Ans: \_\_\_\_\_

29 Some factors of 36 are 1, 2, 3, 4, 6, 12 and 36.  
What are the other two factors of 36?

Ans: \_\_\_\_\_ and \_\_\_\_\_

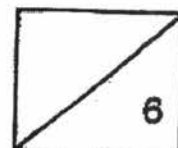

- 30 Sun Yi went for a birthday party.  
The party started at 10 30 and ended at 13 15.  
How long was the party?

Ans: \_\_\_\_\_ h \_\_\_\_\_ min

- 31 Find the missing number in the box.

$$280 \times 25 = \boxed{?} \times 25 + 200 \times 25$$

Ans: \_\_\_\_\_

- 32 Shanice bought some chocolate.  
She ate  $\frac{4}{7}$  of the chocolate and had 300 g of chocolate left.  
How much chocolate did Shanice eat?

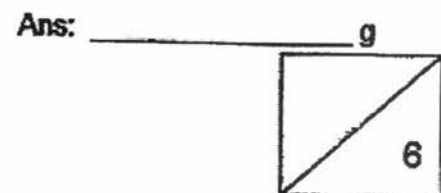

- 33 Samantha has a piece of rectangular cardboard measuring 21 cm by 12 cm as shown below.  
 What is the maximum number of 2-cm squares she can cut out from the cardboard?

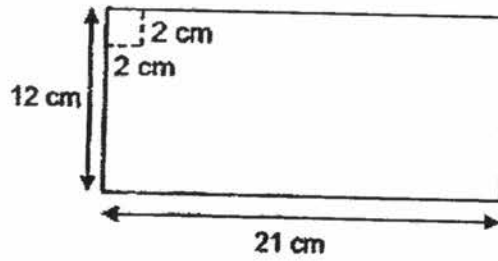

Ans: \_\_\_\_\_

- 34 Draw two straight lines to form a symmetric figure with line AB as the line of symmetry.

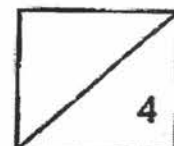
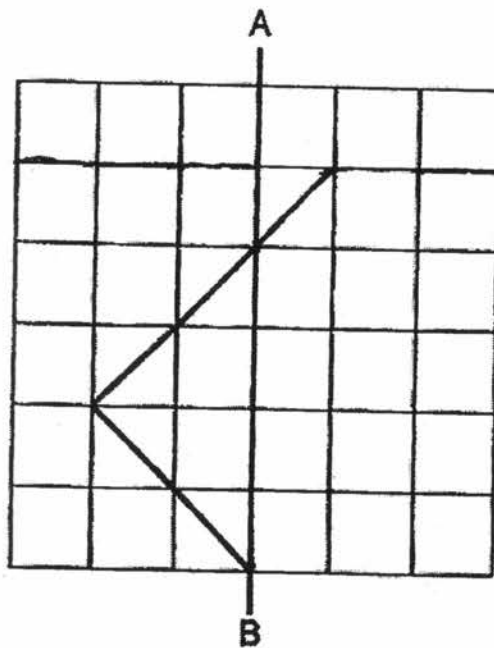

35 Tracy had a total of 5 kg of sugar, cocoa powder and flour.

She had  $2\frac{2}{3}$  kg of sugar and  $1\frac{1}{4}$  kg of cocoa powder.

The rest was flour.

What was the mass of the flour she had?

Ans: \_\_\_\_\_ kg

36 There was some water in a kettle.

Lily poured out 0.9 ℓ of water to cook instant noodles.

She then refilled 800 ml of water into the kettle.

There was 1.5 ℓ of water left in the kettle in the end.

How much water was there in the kettle at first?

Ans: \_\_\_\_\_ ℓ

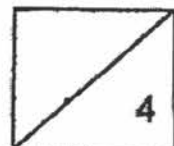



- 37 A container when filled with marbles has a mass of 16.66 kg. When half of the marbles are removed, its mass is 8.88 kg. What is the mass of the container when it is empty?

Ans: \_\_\_\_\_ kg

- 38 The figure below is made up of three rectangles.  $AH = CB$ . Find the total perimeter of the figure.

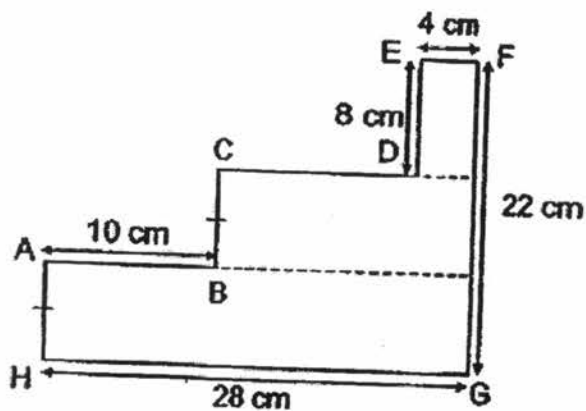

Ans: \_\_\_\_\_ cm

- 39 A movie started at 23 45. It lasted for 2 h 21 min. What time did it end? Leave your answer in 24-hour clock.

Ans: \_\_\_\_\_

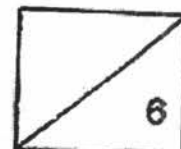

- 40 A bicycle company rents out bicycles by the hour.  
The line graph below shows the hours of bicycle rental over 6 months.

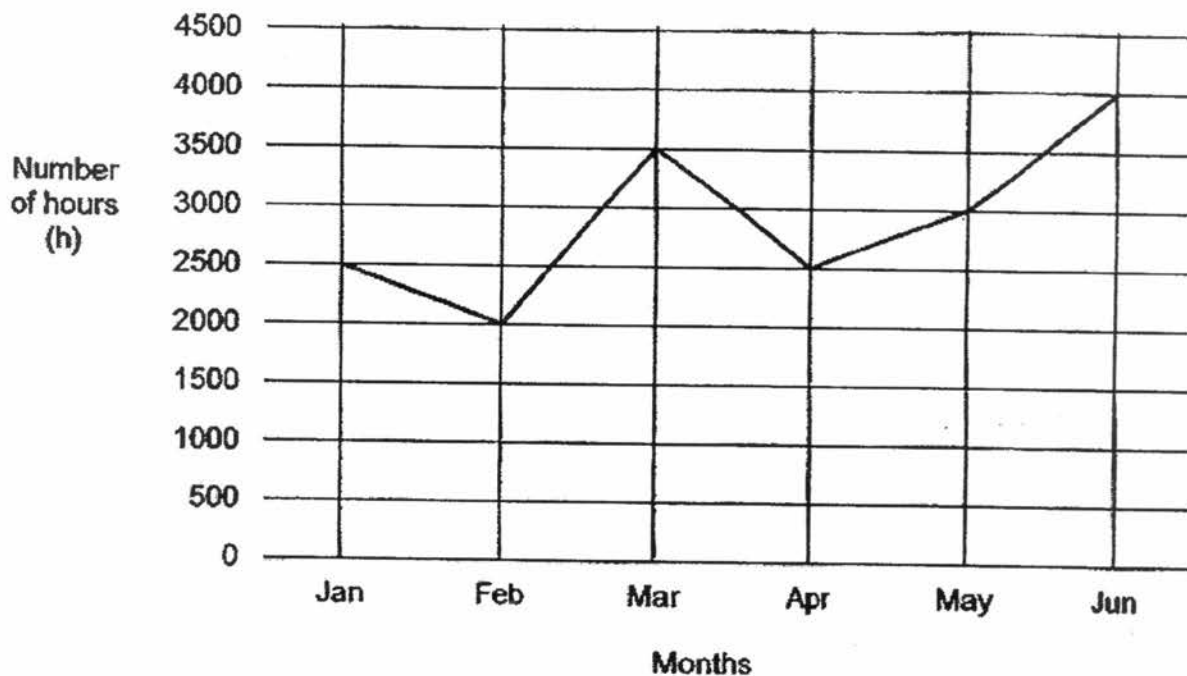

- a) In which month were there 500 fewer hours of bicycle rental than in March?

Ans: \_\_\_\_\_

- b) In which month were there twice as many hours of bicycle rental as in February?

Ans: \_\_\_\_\_

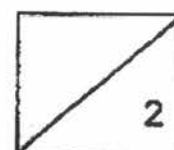

**Section C (5 × 4 = 20 marks)**

**Solve each of the following problems. Show all your working and statements clearly. Write your answers in the spaces provided.**

- 41 Tommy bought a total of 30 waffles and cupcakes.  
Each waffle cost \$1.50.  
Each cupcake cost 3 times as much as a waffle.  
He spent \$69 on the waffles and cupcakes.  
How many waffles did he buy?

Working

Ans: \_\_\_\_\_ [4]

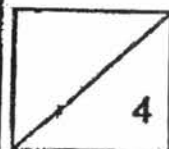

42 Sandy and Theresa shared 2060 marbles equally.  
After Sandy gave some marbles to Theresa, Theresa had 4 times  
as many marbles as Sandy.

- (a) How many marbles did each girl have at the start?  
(b) How many marbles did Sandy give to Theresa?

Working

Ans: (a) \_\_\_\_\_ [2]

(b) \_\_\_\_\_ [2]

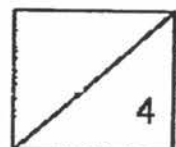

43 Study the diagram below carefully and answer questions (a) to (c).

Working

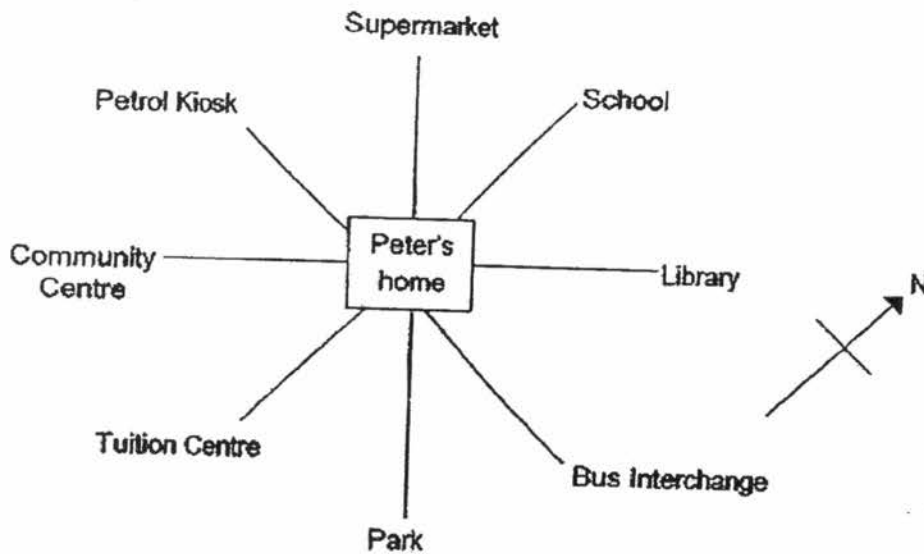

- (a) Which place is situated towards the east of Peter's home?
- (b) Peter's mother was at home facing the South-west direction. After she turned an angle of  $45^\circ$  in the anti-clockwise direction and followed by a  $135^\circ$  turn in the clockwise direction, which place would she be facing then?
- (c) After making a  $\frac{1}{4}$ -turn clockwise and followed by a  $\frac{1}{2}$ -turn, Peter was facing the Library. Which place was he facing at first?

Ans: (a) \_\_\_\_\_ [1]

(b) \_\_\_\_\_ [1]

(c) \_\_\_\_\_ [2]

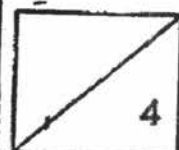

44 Uncle Simon sold some fruits.

Working

$\frac{1}{4}$  of the fruits sold were peaches.

$\frac{2}{3}$  of the fruits sold were apples.

The rest were oranges.

Uncle Simon sold 28 more apples than oranges.

How many fruits did he sell altogether?

Ans: \_\_\_\_\_ [4]

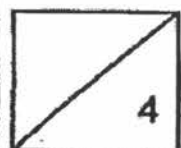

- 45 A path of length 880 cm is completely covered with identical tiles, following the pattern shown below. The width of the path is 12 cm.

Working

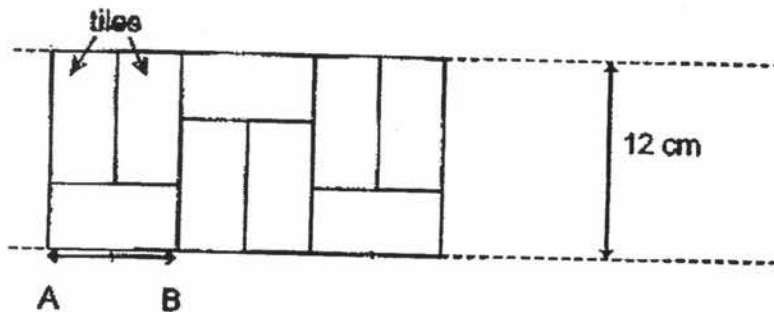

- (a) What is the length of AB?  
 (b) How many tiles were used to cover the entire path?

Ans: (a) \_\_\_\_\_ [1]

(b) \_\_\_\_\_ [3]

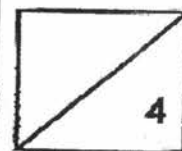

- End of Paper -

EXAM PAPER 2017 (P4)

SCHOOL : PEI HWA

SUBJECT : MATHEMATICS

TERM : SA2

ORDER CALL :

Q1	Q2	Q3	Q4	Q5	Q6	Q7	Q8	Q9	Q10
4	4	1	1	3	1	3	1	3	4
Q11	Q12	Q13	Q14	Q15	Q16	Q17	Q18	Q19	Q20
3	2	4	1	3	4	4	4	1	1

21)400      22)4      23)P      24)30°      25)11/8      26)19

27)7/10      28)44.34      29)9 and 18      30)2 h 45 min      31)80

32)400g      33)60 2 cm squares      34)

35)11/12      36)1.6L

37)16.66 - 8.88 = 7.78

8.88 - 7.78 = 1.1 kg

38)28 + 28 + 22 + 22 = 100 cm

39)02 06

40)a)May

b)June

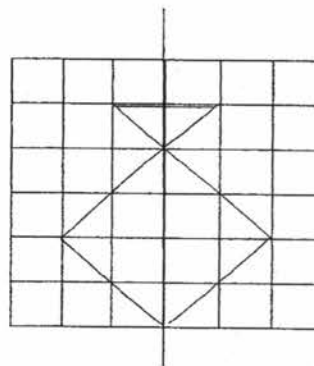



41)  $150 \times 3 = 450$

$30 \times 150 = 4500$

$6900 - 4500 = 2400$

$2400 \div 300 = 8$

$8 \times 450 = 3600$

$22 \times 150 = 3300$

$3300 + 3600 = 6900$

Tommy bought 22 waffles.

42)a)  $2 + 2 + 1 = 5$

$4 + 1 = 5$

$5 \times 2 = 10$

$1u \rightarrow 2060 \div 10 = 206$

$5u \rightarrow 206 \times 5 = 1030$

Each girl had 1030 marbles at first.

b)  $3u \rightarrow 206 \times 3 = 618$

Sandy gave 618 marbles to Theresa.

43)a) The place is the Bus interchange

b) She would be facing the Supermarket

c) Peter was facing the Park at first

44)  $8 + 3 = 11$

$12 - 11 = 1$

$8 - 1 = 7$

1u →  $28 \div 7 = 4$

12u →  $12 \times 4 = 48$

He sold 48 fruits altogether

45)a)  $12 \div 3 = 4$

$4 \times 2 = 8 \text{ cm}$

The length of AB is 18cm

b) 1u →  $880 \div 8 = 110$

$110 \times 3 = 330$

$330 \div 3 = 110$

$110 \times 8 = 880$

330 tiles were used to cover the entire path.