

PAYA LEBAR METHODIST GIRLS' SCHOOL (PRIMARY)

END-OF-YEAR EXAMINATION, 2020

PRIMARY FOUR

SCIENCE

BOOKLET A

NAME : _____ ()

CLASS : P4 _____

DATE : 3 November 2020

TOTAL TIME FOR BOOKLETS A & B: 1 hour and 45 minutes

INSTRUCTIONS TO PUPILS

DO NOT OPEN THIS BOOKLET UNTIL YOU ARE TOLD TO DO SO.

ANSWER ALL QUESTIONS.

Section A: Multiple Choice Questions (56 marks)

For each question from 1 to 28, four options are given. One of them is the correct answer. Make your choice (1, 2, 3 or 4) and shade your answer on the Optical Answer Sheet.

1. Which one of the following objects can be bent easily without breaking?



a towel



a plastic spoon



a sheet of glass

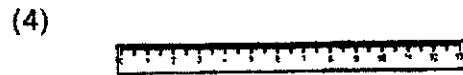

a wooden ruler

2. Which part, (1), (2), (3) or (4), takes in water for the plant?

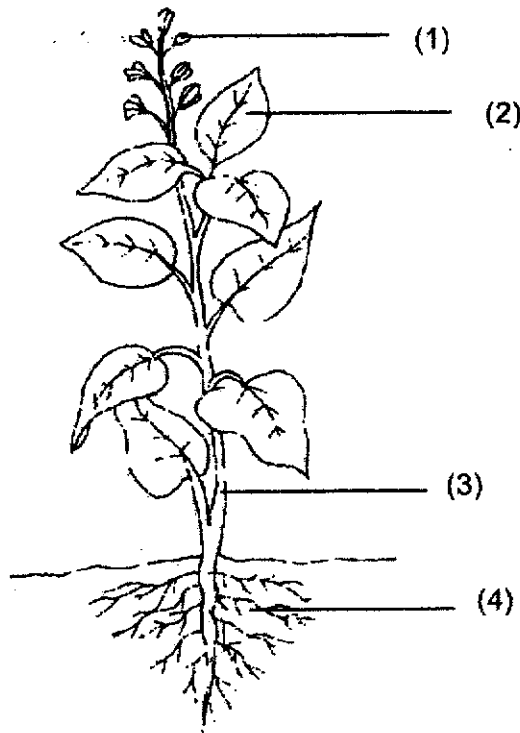

3. Which one of the animals shown below is NOT an insect?

(1)

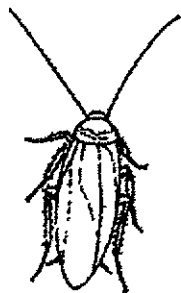

(2)

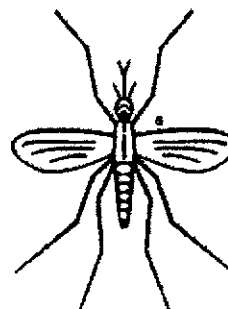

(3)

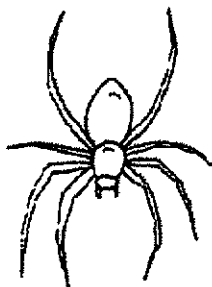

(4)



4. In which part of the digestive system allows water to be absorbed into the blood?

- (1) gullet
- (2) mouth
- (3) stomach
- (4) large intestine

5. Tim made the following observations on the life cycle of an animal.

- There are 3 stages in the life cycle.
- The young does not look like the adult.

Which animal was Tim observing?

- (1) frog
- (2) beetle
- (3) butterfly
- (4) cockroach

6. In which one of the following will the two magnets pull each other together?

(1)



(2)

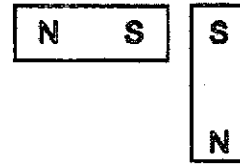

(3)

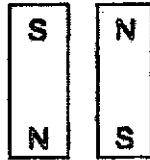

(4)

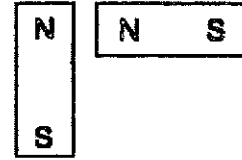

7. The reading on the weighing scale shows that the mass of the apples is _____ kg.

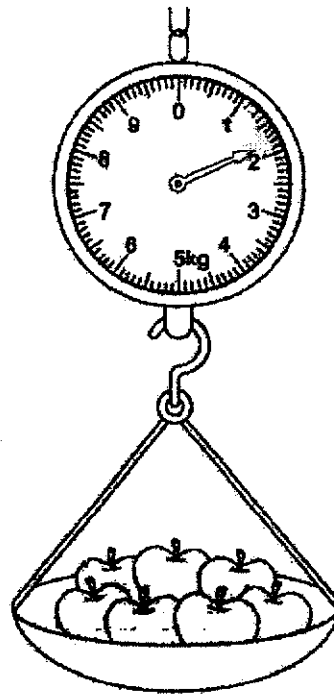

- (1) 1.4
- (2) 1.6
- (3) 1.8
- (4) 2.2

Look at the picture below.

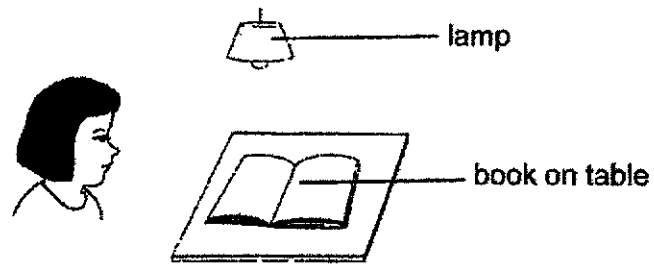

Which one of the following diagrams explains why Jane can see the book on the table?

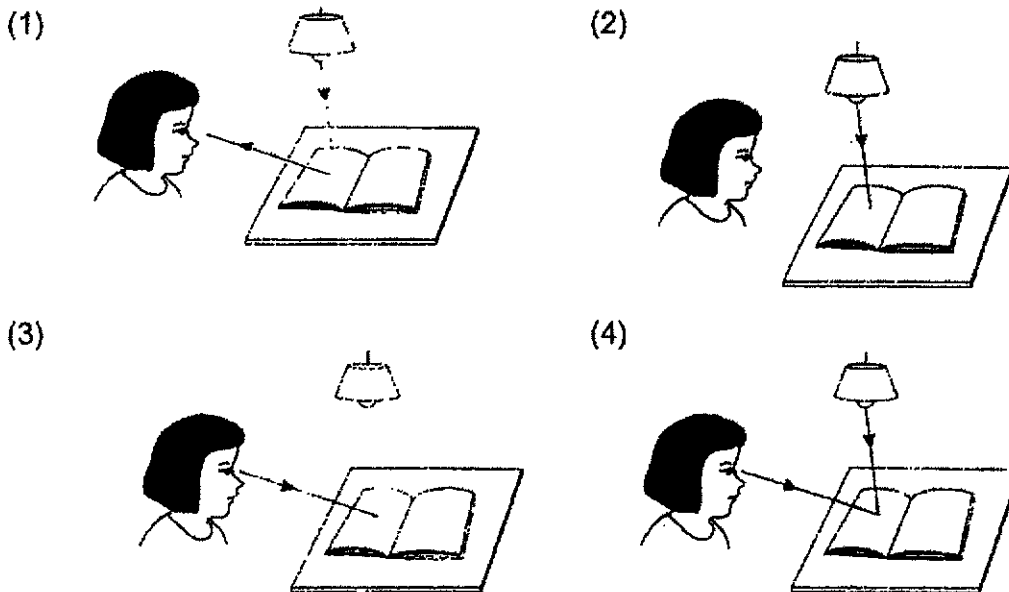
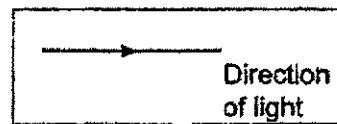

9. Which one of the following is **NOT** a source of heat?

- (1) The Sun
- (2) A blanket
- (3) A hot iron
- (4) A lighted bulb

10. Raj boiled some water in the pot shown below.

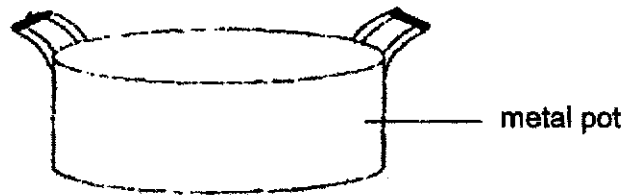

He is able to boil water using the metal pot. This is because metal is a

- (1) light material
- (2) flexible material
- (3) good conductor of heat
- (4) poor conductor of heat

Catherine would like to use a heat sensor connected to a datalogger to measure the temperature of a beaker of hot water.

Which one of the following diagrams shows the correct position of the heat sensor when taking the temperature reading?

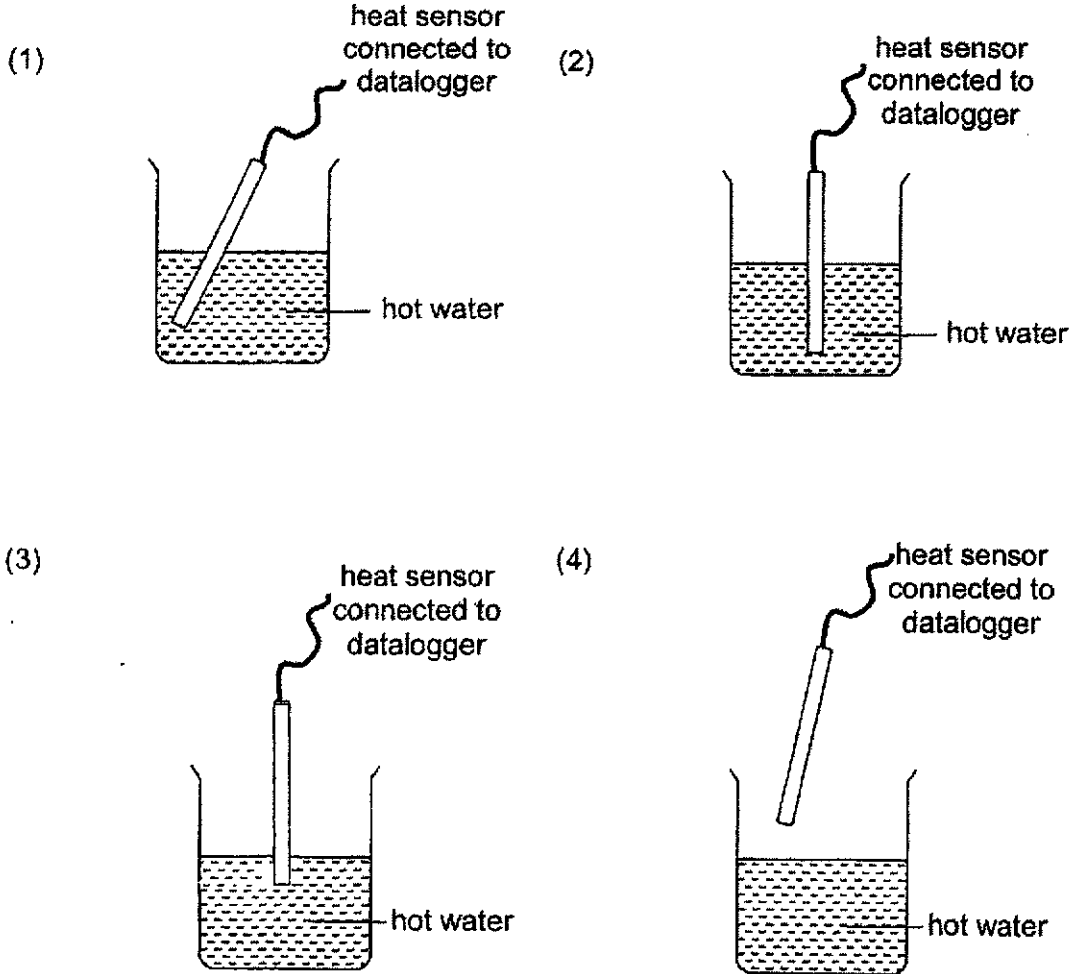

12. An experiment was carried out with 4 objects A, B, C and D. The objects were made of different types of materials of similar size and thickness. They were dropped in a tank of water as shown in the diagram below.

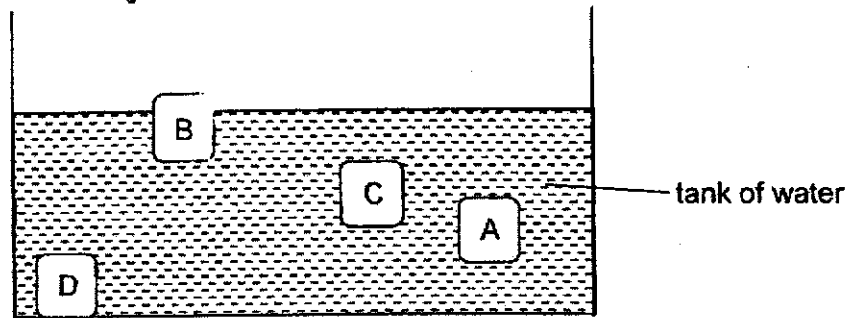

Four children made a statement regarding the four objects in the tank.

- Angela: Object A sinks in water.
 Bernand: Object B floats on water.
 Casey: Object C floats on water.
 Denise: Object D sinks in water.

Who has/have made the correct statements regarding the experiment?

- (1) Casey only
 (2) Denise only
 (3) Angela and Bernand only
 (4) Bernand and Denise only
13. Susan placed some fish in a tank and observed the number of fish in the tank after a month. She recorded her observations in the table below.

	At the start	After one month
Number of fish	10	20

Based on the above, which characteristic of living thing is observed?

- (1) They grow.
 (2) They reproduce.
 (3) They respond to changes.
 (4) They need air, food and water to survive.

Tommy saw a tree that had been struck by lightning during a recent thunderstorm at the back of his school field. He noticed that the leaves at part A has turned yellow.

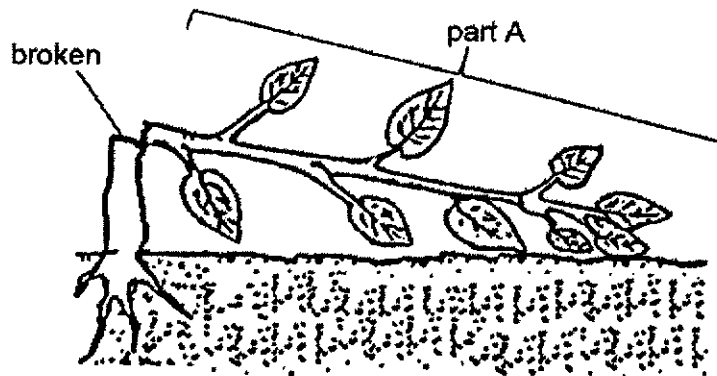

What could be the main reason that the leaves have turned yellow?

- (1) The leaves cannot hold the plant upright.
- (2) The roots cannot take in water from the ground.
- (3) The roots cannot anchor the plant to the ground.
- (4) The stem cannot transport water to the leaves to make food.

15. The diagram below shows the human digestive system.

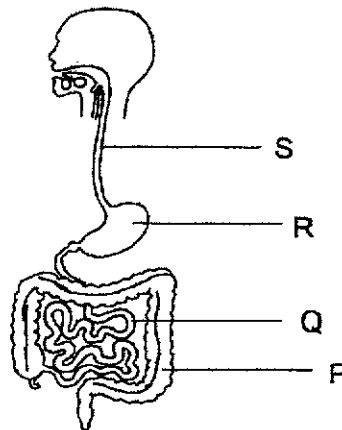

Which one of the following statement correctly describes what happens at parts P, Q, R and S?

	Part	Description
(1)	P	Undigested food is absorbed into the bloodstream.
(2)	R	Food is absorbed into the bloodstream.
(3)	S	Food is not digested.
(4)	Q	Food is broken into smaller pieces.

16. The diagrams below show the life cycles of organisms A and B.

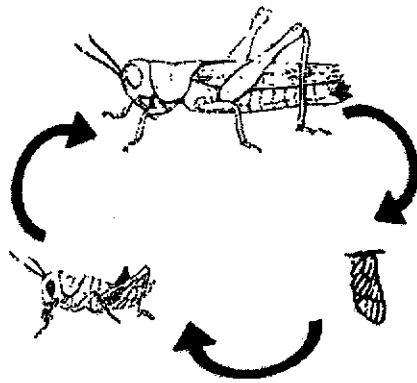

life cycle of organism A

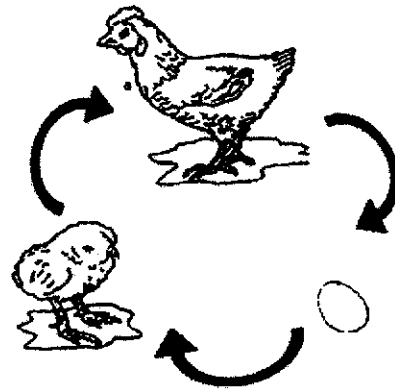

life cycle of organism B

Based on the diagrams above, which of the following statement(s) is/are correct?

- A The adult of both organisms lay eggs.
- B There are three stages in each life cycle.
- C Both the young of the organisms A and B do not resemble their adults.

- (1) A only
- (2) A and B only
- (3) B and C only
- (4) C and D only

Janine tried to remove a pin from a tray of objects consisting of plastic beads by using a bar magnet as shown below.

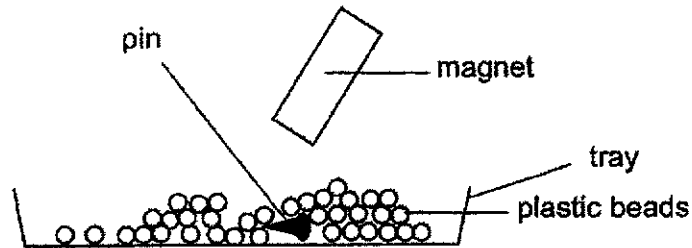

Which one of the following statements explains why Janine was able to remove the pin from the beads?

- (1) The pin is not magnetic.
- (2) The plastic beads can be magnetised.
- (3) The pin is made of a magnetic material.
- (4) The plastic beads are made of magnetic materials.

18. Bradley placed a bar magnet on his toy boat. He placed the toy boat into a bucket of water and let it float as shown below.

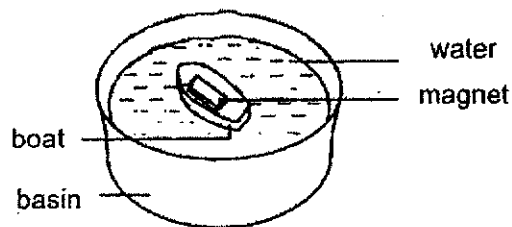

He stated that his boat can act as a compass. Based on his observation, what is the property of a magnet that allows Brad to use it as a compass?

- (1) Magnets attract magnetic materials.
- (2) Like poles facing each other will repel.
- (3) Unlike poles facing each other will attract.
- (4) Suspended magnets come to rest in the North-South direction.

19. Arun wanted to find out if the number of wire coils around the nail affects the strength of the electromagnet.

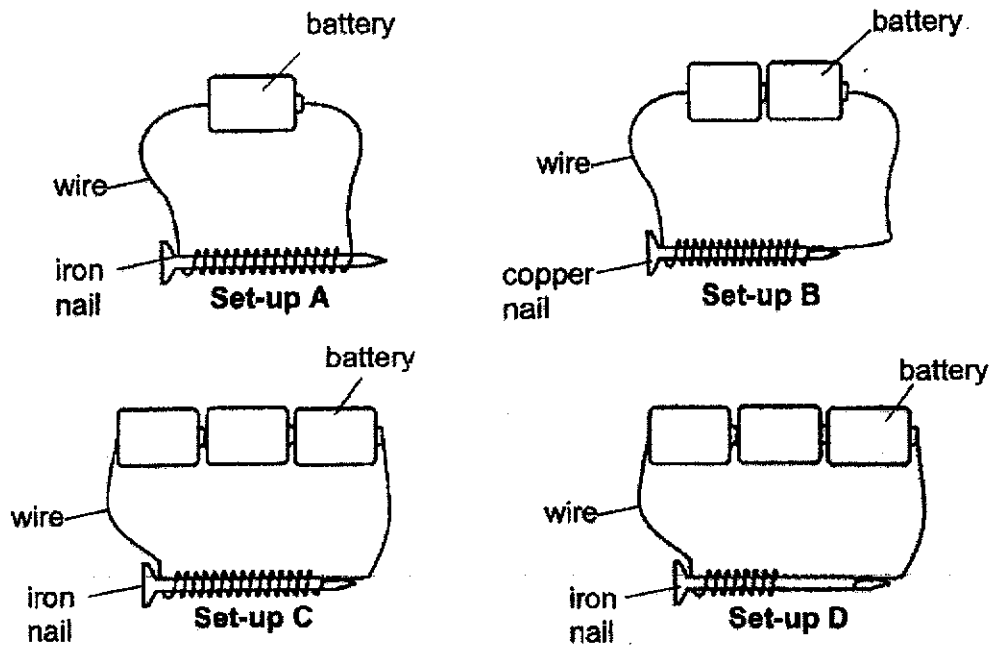

Which of the following set-ups should he use?

- (1) A and B
- (2) A and C
- (3) B and D
- (4) C and D

- Diagram 1 below shows a bar magnet. Diagram 2 shows the bar magnet being lowered on a tray of steel paper clips.

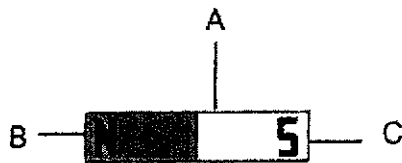

diagram 1

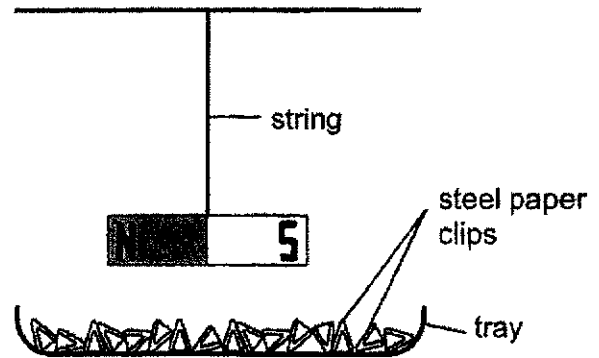
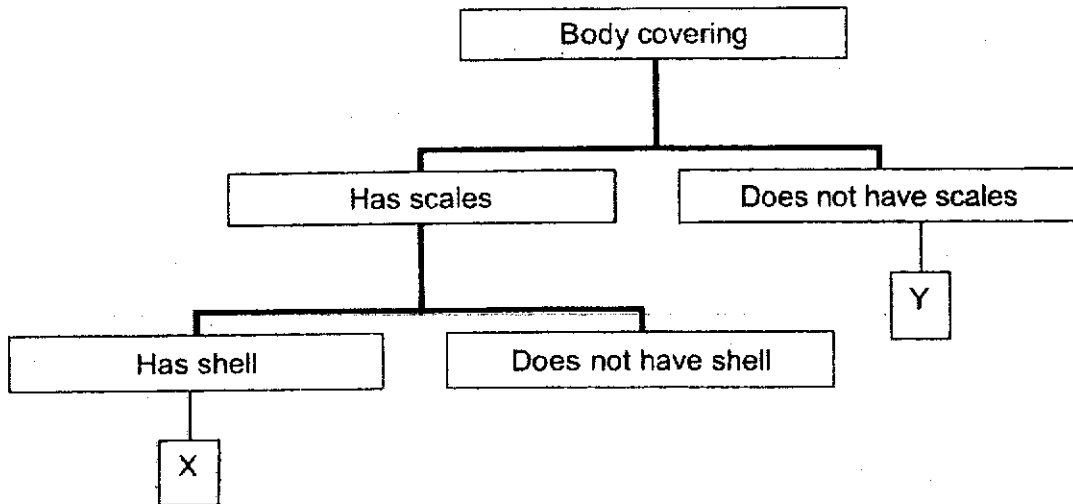
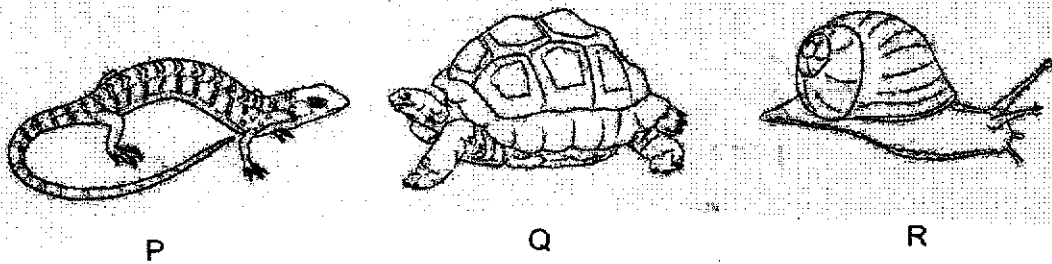

diagram 2

Which of the following most likely shows the number of steel paper clips attracted to the points A, B and C as shown in diagram 1?

	A	B	C
(1)	14	6	12
(2)	10	10	10
(3)	6	10	12
(4)	7	14	6

21. Study the classification chart and the three animals, P, Q and R.



Which of the following shows the correct classification of animals in boxes X and Y?

	X	Y
(1)	R	P
(2)	Q	R
(3)	P	R
(4)	Q	P

22. Jonas blew to inflate the balloon in this set-up but he failed.

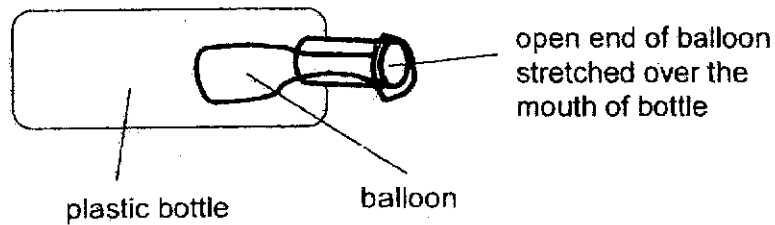

Which one of the following statements explains his observation?

- (1) The bottle is too big.
- (2) The balloon is too small.
- (3) There is no air in the balloon.
- (4) There is air occupying space in the plastic bottle.

Yusrina has two identical bottles filled with the same amount of water. She placed bottle A in the freezer and left the other bottle on the table. Both bottles were left overnight.

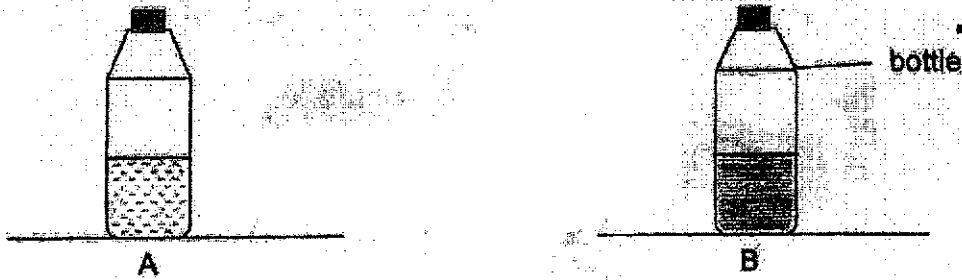

The next day, Yusrina put both bottles together and tilted them.

Which one of the following sets of bottles correctly shows what happens when they are slightly tilted to the right?

(1)



(2)



(3)



(4)

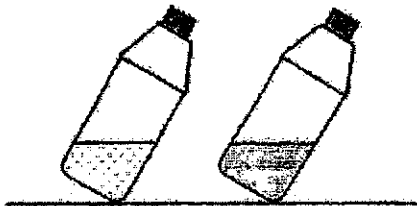



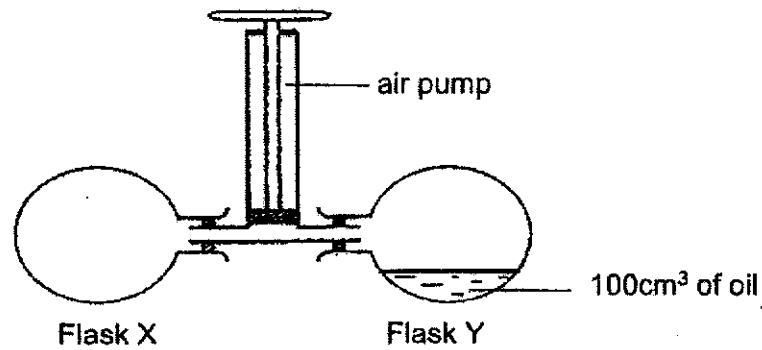

24. Juliana set up an experiment as shown below. She connected two flasks X and Y, each with a capacity of 400cm^3 , to an air pump. 200cm^3 of air is pumped into each of the conical flask.



What is the amount of air in each of flasks X and Y when the air pump is pushed down once?

	Flask X	Flask Y
(1)	400 cm^3	300 cm^3
(2)	600 cm^3	300 cm^3
(3)	600 cm^3	500 cm^3
(4)	700 cm^3	500 cm^3

25. All objects have a mass of 2kg each.

<p>A steel ball</p>  <p>Volume: 2110 cm³</p>	<p>A metal box</p>  <p>Volume: 2150 cm³</p>
<p>A bag of feathers</p>  <p>Volume: 2180 cm³</p>	<p>A bag of flour</p>  <p>Volume: 2130 cm³</p>

Which one of the following statements is true about the objects?

- (1) The bag of feathers is the lightest.
- (2) All the objects have definite volume.
- (3) All the objects occupy the same space.
- (4) The metal box has the most mass among all the objects.

26. Sally poured 300 ml of water at 90°C into 4 different cups made of different materials as shown below.

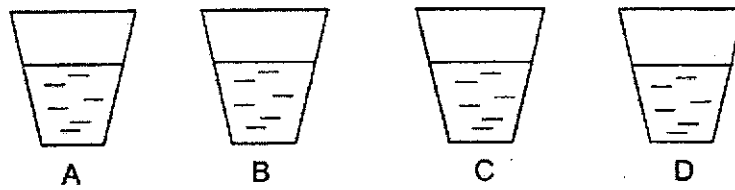

The table below shows the temperature of the water in the cups 15 minutes later.

Cup	Temperature ($^{\circ}\text{C}$)
A	80
B	65
C	50
D	35

Based on the information in the table above, which material would be most suitable to make a container to store ice cream?

- (1) A
- (2) B
- (3) C
- (4) D

27. Jenny conducted an experiment. She filled two beakers with 200ml of hot water. She placed a metal ruler inside beaker B. She recorded the time taken for the hot water in both beakers to reach the room temperature of 25 °C.

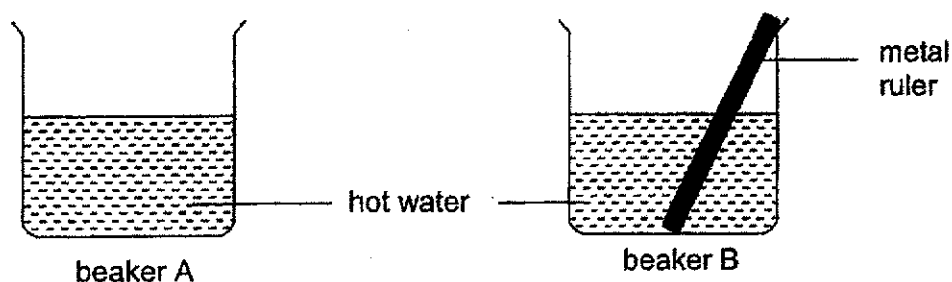

The results of her experiment are shown below.

Beaker	A	B
Time taken for hot water to reach room temperature (minutes)	40	25

Which one of the following explains why the water took a shorter time to reach room temperature when a metal ruler was put inside the beaker of hot water?

- (1) The metal ruler expanded and reduced the temperature of water.
- (2) The metal ruler lost heat to the water and reduced the temperature of the water.
- (3) The metal ruler is a poor conductor of heat so it conducted heat away from the water.
- (4) The metal ruler is a good conductor of heat so it conducted heat away from the water quickly.

28. Jessie placed a glass of hot chocolate in a basin of cold water as shown below.

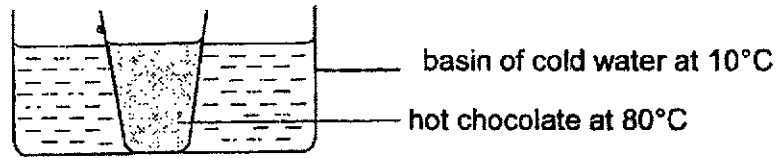

Jessie left her set-up in the room at 30°C for 20 minutes.

Which one of the following statements is true about her set-up 20 minutes later?

	Observation	Explanation
(1)	Temperature of cold water increased.	It lost heat to the surrounding air.
(2)	Temperature of hot chocolate increased.	It gained heat from the cold water.
(3)	Temperature of cold water increased.	It gained heat from the hot chocolate.
(4)	Temperature of hot chocolate remained the same.	It did not lose heat to the surrounding.

END OF SECTION A

PAYA LEBAR METHODIST GIRLS' SCHOOL (PRIMARY)**END-OF-YEAR EXAMINATION, 2020****PRIMARY FOUR****SCIENCE****BOOKLET B****NAME** : _____ ()**CLASS** : P4 _____**DATE** : 3 November 2020**TOTAL TIME FOR BOOKLETS A & B: 1 hour and 45 minutes**

BOOKLET A	/ 56
BOOKLET B	/ 44
TOTAL	/100

Parent's Signature: _____

INSTRUCTIONS TO PUPILS**DO NOT OPEN THIS BOOKLET UNTIL YOU ARE TOLD TO DO SO.****ANSWER ALL QUESTIONS.**

SECTION B: 44 Marks

For questions 29 to 41, write your answers in the spaces provided. The number of marks available is shown in brackets [] at the end of each question or part question.

29. Fill in the blanks in the table with the names of broad groups of living things. [2]

Group	Characteristics
	Dry skin, with scales
	Body covered with hair

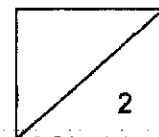

30. The diagram below shows the stages in the life cycle of a mosquito.

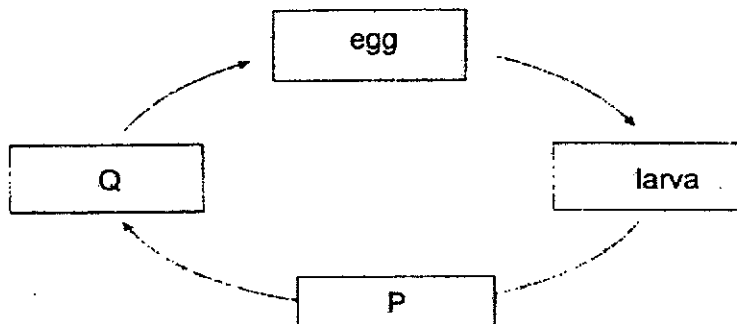

(a) Choose the correct words from the box to answer the question below. [2]

wiggler	adult	pupa	nymph
---------	-------	------	-------

Name the two stages **P** and **Q**

P : _____

Q : _____

(b) State one other animal that has a similar life cycle as a mosquito. [1]

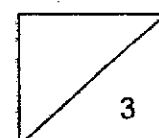

Marie places a magnet near an iron nail. The iron nail moves towards the magnet.

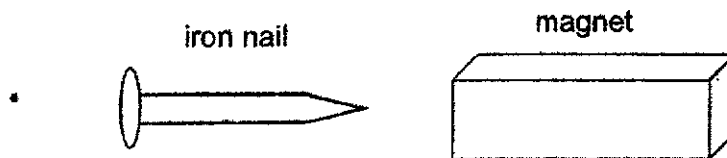

(a) The magnet exerts _____ on the iron nail. [1]

(b) Choose the correct word from the box to answer the question below. [1]

strong	magnetic	flexible
--------	----------	----------

Marie's observation shows that iron is a _____ materials.

(c) Marie then stroked two similar iron nails X and Y with the same magnet as shown in the figure below.

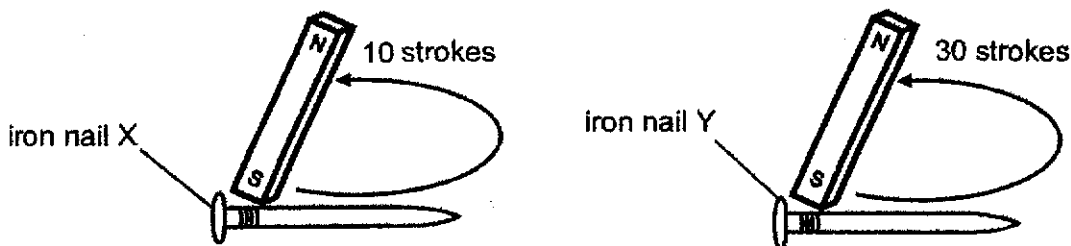

Both nails became magnets and were used to attract similar pins

Nail X attracted _____ Nail Y. Tick (✓) the correct answer below. [1]

less pins than	<input type="checkbox"/>
the same number of pins as	<input type="checkbox"/>
more pins than	<input type="checkbox"/>

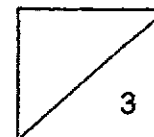

32. The diagram shows a beaker of water.

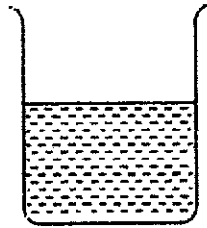

Fill in the blanks using the correct words in the box.

solid	increases	gas
remains unchanged	decreases	

(a) When heat is removed from the water, its temperature _____ . [1]

(b) The beaker of water is then put in the freezer. After some time, the water will change its state to become _____ . [1]

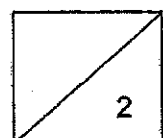

Study the diagram of a plant below.

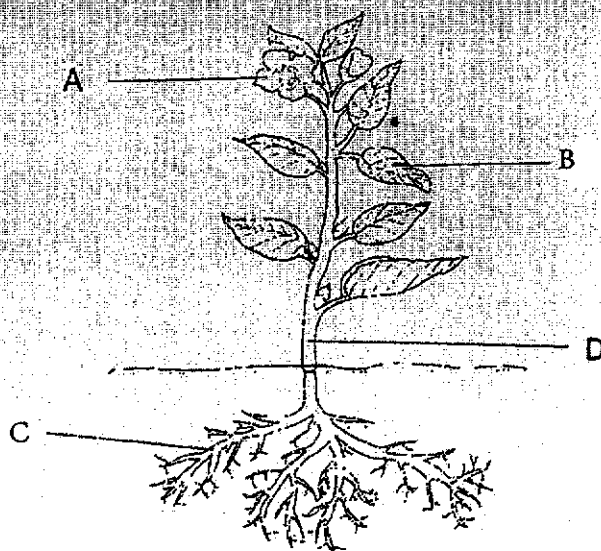

(a) Name the parts of the plant. [2]

B: _____

C: _____

(b) What is the function of part B? [1]

(c) How does the plant above reproduce? [1]

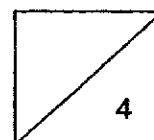

34. The diagram below shows a section of a brick wall with gaps between the bricks.

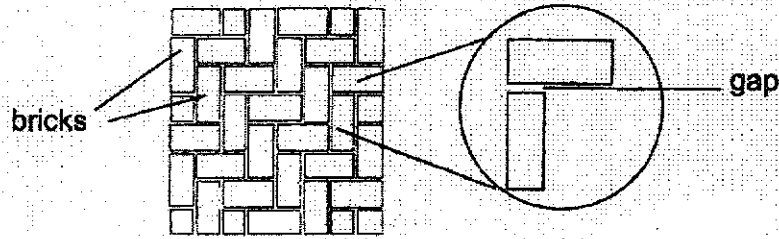

(a) What would happen to the gaps on a hot day? Explain your answer. [2]

(b) The graph below compared the temperature changes of a brick with two other materials, A and B, by heating them with the same amount of heat.

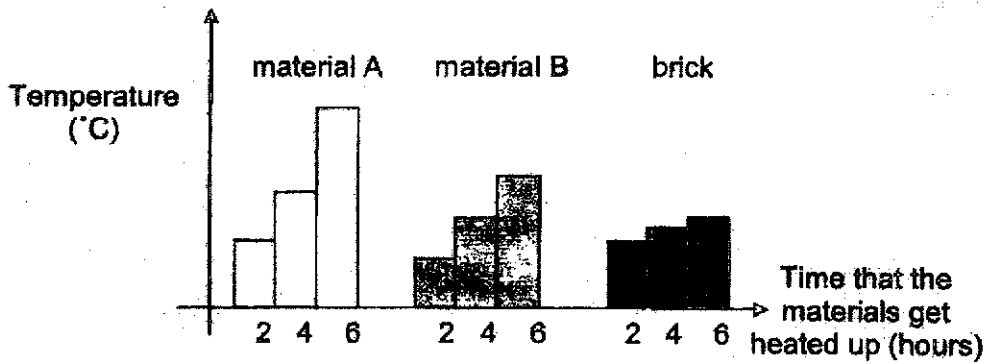

(b) What is the relationship between the temperature of the brick and the amount of time it gets heated up? [1]

(c) From the above graph, which material, A, B or the brick, has the greatest temperature change as it was heated up? [1]



Carrie conducted an experiment on three materials, S, T and U as shown below.

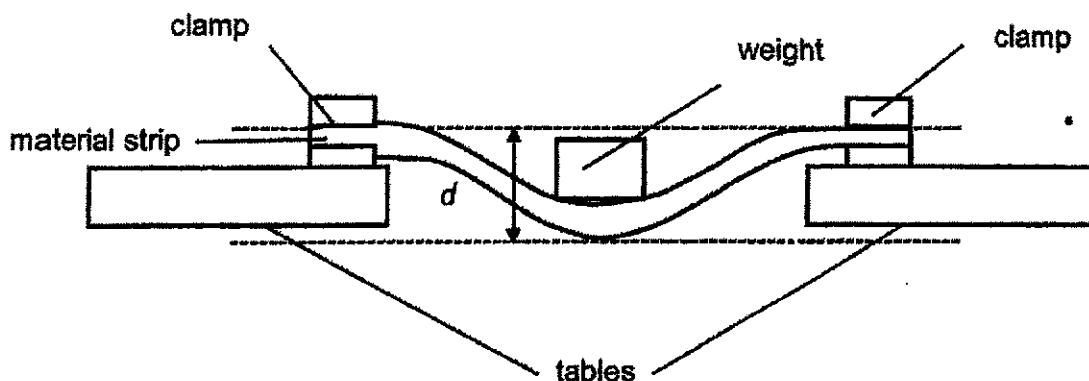

She clamped each material strip on two tables and placed a 3kg weight on the centre of each material. She measured distance d as show above. She recorded her results in the table below.

Material	Distance d (cm)
S	0
T	5
U	3

- (a) Based on the results above, which property of material was Carrie trying to investigate? [1]

- (b) Put a tick (\checkmark) in the appropriate box(es) to indicate the variable(s) that Carrie must keep the same to ensure a fair test. [1]

Variable	Keep the same
Type of material	<input type="checkbox"/>
Thickness of the strip	<input type="checkbox"/>
Distance between the two clamps	<input type="checkbox"/>
Amount of weight placed on the material	<input type="checkbox"/>

(c) Carrie wanted to make a shelf to hold plants without any falling over.

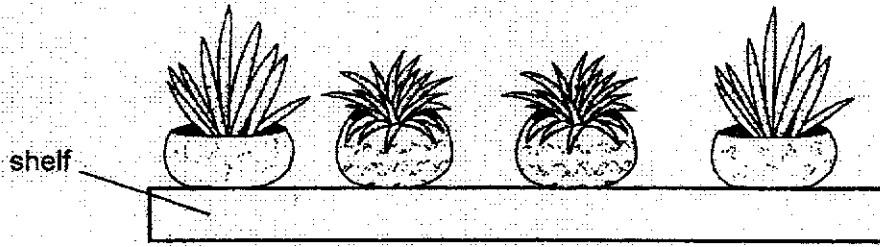

Based on the results of her experiment, which material S, T or U is most suitable to make the shelf? Explain your choice. [2]

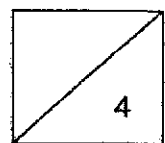

The diagram below shows human system X which works together with the human digestive system to help humans survive.

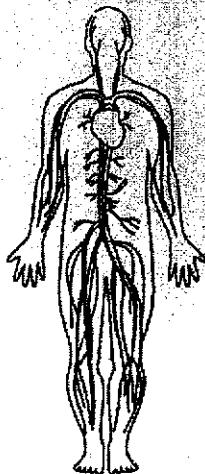

system X

(a) State the name of system X.

[1]

The diagram below shows a part of the small intestine.

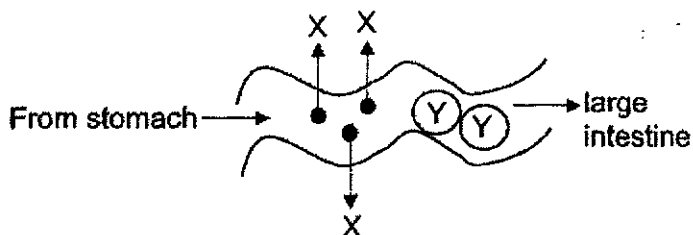

(b) Identify substances X and Y.

[1]

X: _____

Y: _____

(c) Name all the organs in the digestive system that produce digestive juices.

[1]

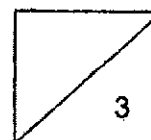

37. Jack placed two bar magnets on a table as shown below. Both magnets moved when they were released.

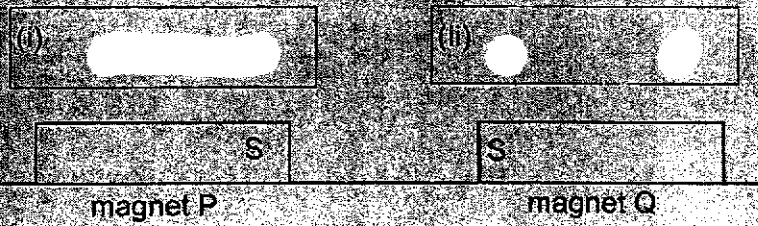

(a) Draw the direction of the movement of both magnets in the boxes above using two arrows. [1]

(b) Jack has a toy ball G as shown below.

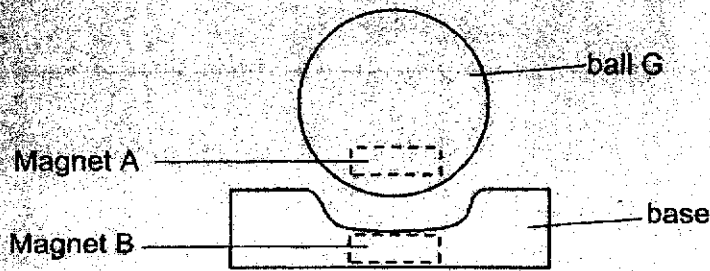

Explain why ball G was able to 'float' above the base. [2]

(c) When magnet B is replaced with a non-magnetic object, what would happen to ball G? [1]

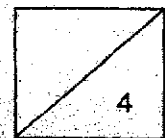

Carl placed 30 ml of water in a measuring cylinder and then added five grapes into the measuring cylinder.

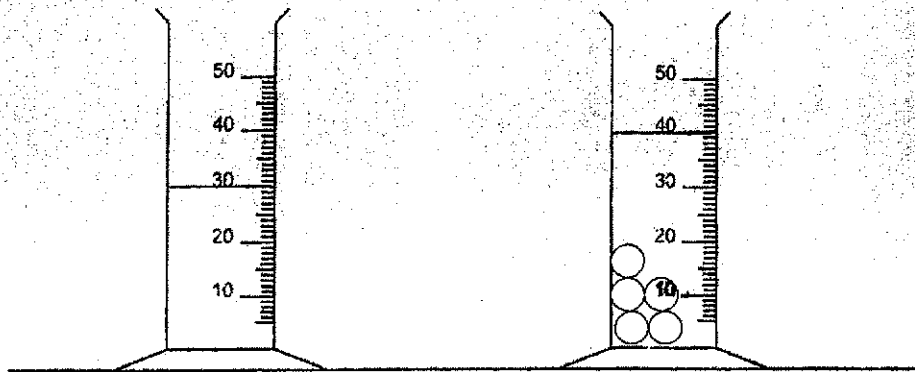

He observed that the volume of water increased when he added the grapes in.

- (a) State the property of matter which he observed above. [1]

- (b) What is the state of matter for the following objects?
Fill in the blanks in the table below. [1]

object	state of matter
water in measuring cylinder	
grapes	

- (c) What is the volume of each grape? [1]

_____ cm³

(d) Carl added the grapes to a drink in a glass as shown below.

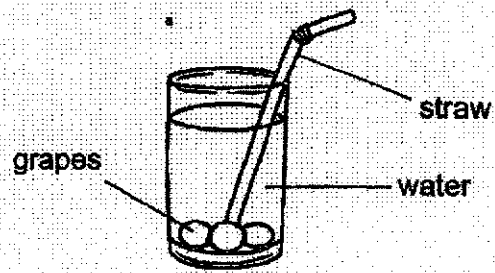

He realised that he could not suck the grapes up the straw. Based on a property of matter, explain the reason. [1]

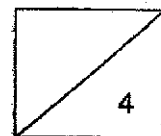

Alica gently lowered object X into a container of water and observed the height of the water level in the container as shown below.

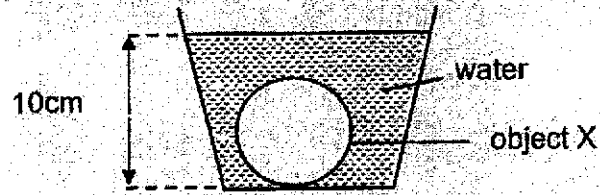

Then, she took out object X, without spilling any water, and rolled it into three different shapes.



- (a) What was the height of the water level when she lowered all the shapes of object X into the same container again? Tick (✓) the correct answer in the table below. [1]

less than 10 cm	
equal to 10 cm	
more than 10 cm	

- (b) Explain your answer in (a). [1]

In another experiment, Alicia cut off the bottoms of two identical plastic bottles, A and B. Then, she lowered them into a container of water as shown below. Only the cap of bottle A was removed.

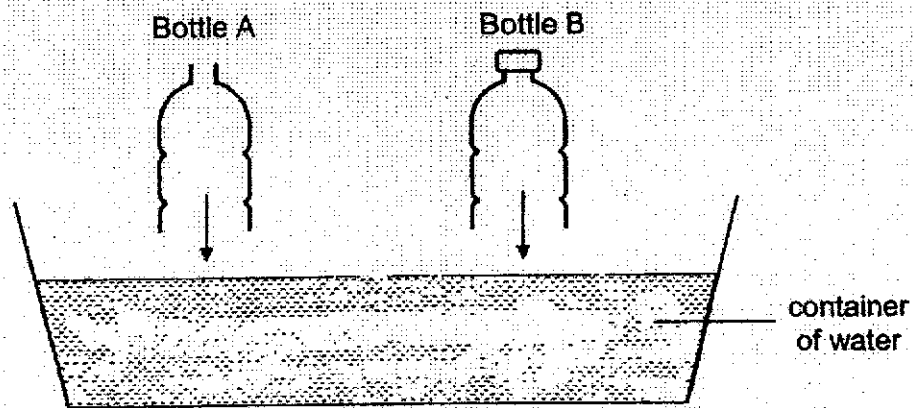

- (c) Which bottle, A or B, was easier for him to push down into the container of water? Explain your answer. [2]
-
-

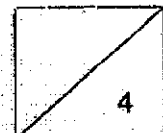

Jennifer made a game using the objects shown below.

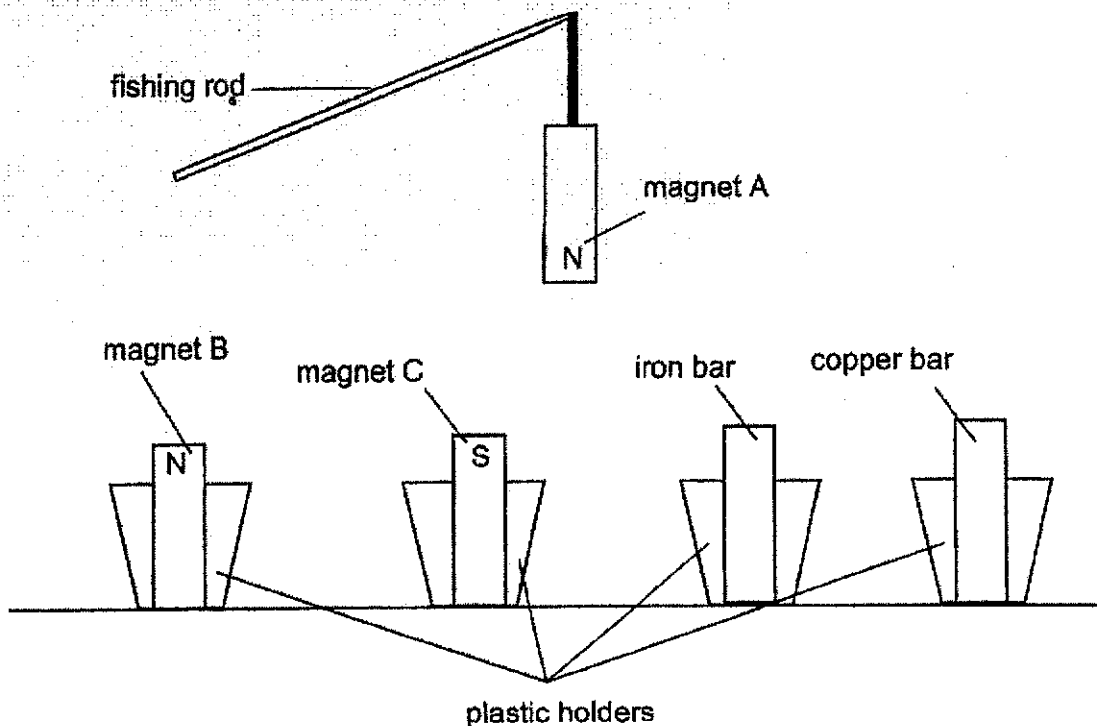

Which two objects will she be able to pick up using the fishing rod? Explain your answer. [3]

Object 1:

Reason:

Object 2:

Reason:

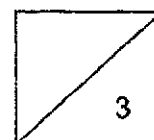

41. Dinah carried out an experiment to find out whether a metal cup or plastic cup would keep her drink warm. She sealed both cups and used heat sensors to measure the temperature of the water in the 2 cups every 5 minutes.

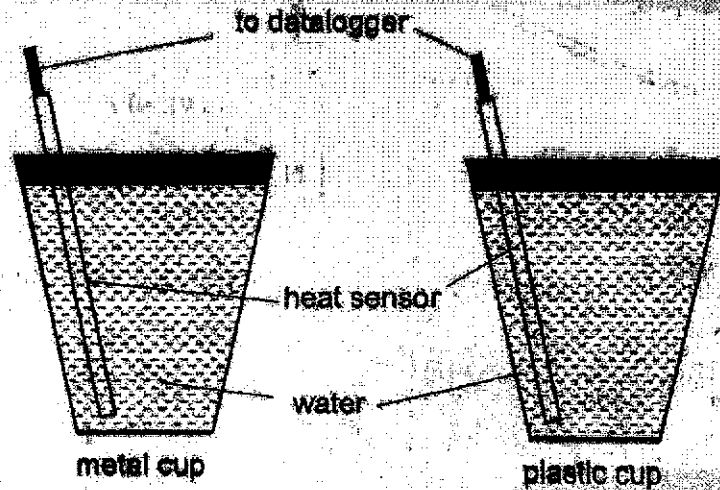

- (a) Graph X and graph Y below show the change of temperature of the water in the metal cup and glass cup in 30 minutes. In the graph below, label 'metal cup' or 'plastic cup' in the boxes provided. [1]

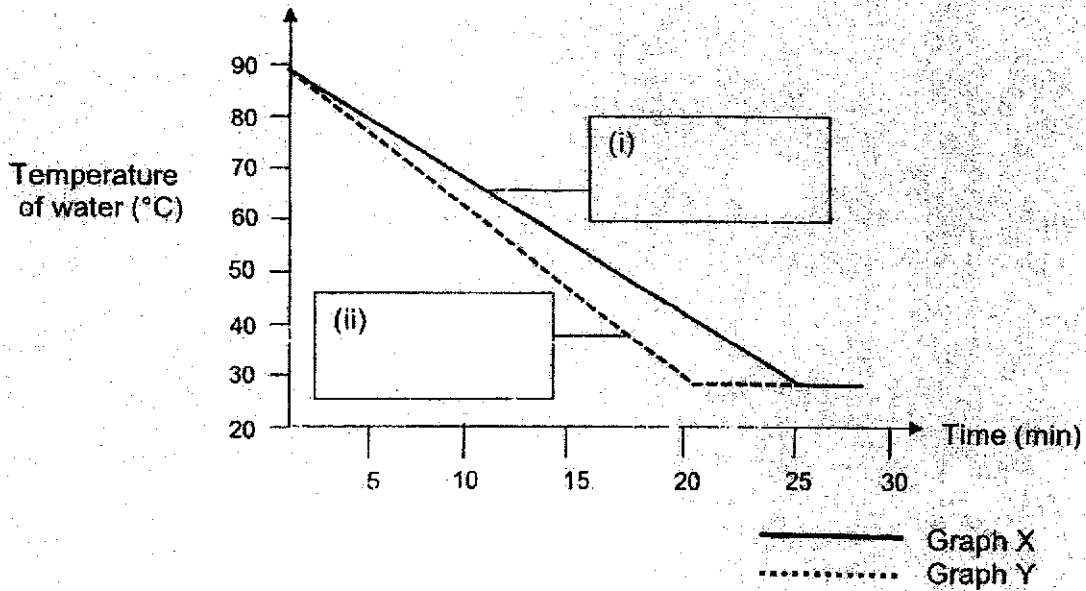

- (b) Explain your answer in (a). [2]

Dinah took out two similar pieces of food from the freezer. She put the food on the two plates. The two plates are made of different materials as shown below.

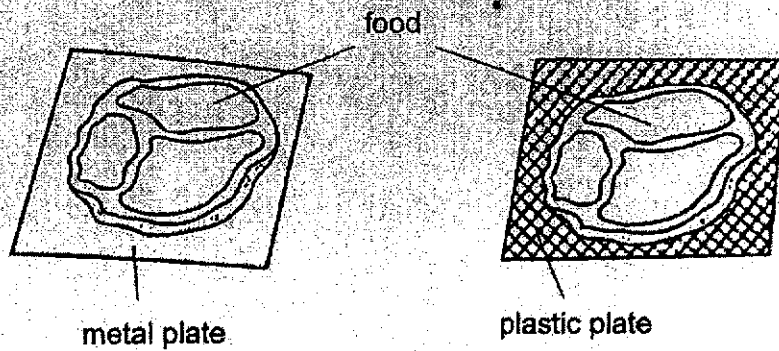

- (c) Which material, metal or plastic, would be more suitable to warm the food faster? Explain your answer. [1]

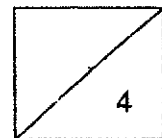

END OF SECTION B

SCHOOL : PAYA LEBAR METHODIST GIRLS' SCHOOL
LEVEL : PRIMARY 4
SUBJECT : SCIENCE
TERM : 2020 SA2

SECTION A

Q1	Q2	Q3	Q4	Q5	Q6	Q7	Q8	Q9	Q10
1	4	3	4	1	3	3	1	2	3

Q11	Q12	Q13	Q14	Q15	Q16	Q17	Q18	Q19	Q20
2	4	2	4	3	2	3	4	4	3

Q21	Q22	Q23	Q24	Q25	Q26	Q27	Q28
2	4	2	1	2	1	4	3

SECTION B

Q29)	Reptiles Mammals
Q30)	(a) P: pupa Q: adult (b) butterfly
Q31)	(a) pull (b) magnetic (c) less pins than
Q32)	(a) Decreases (b) Solid
Q33)	(a) B: leaves

	<p>C: roots</p> <p>(b) B traps sunlight to make food for the plant</p> <p>(c) By seeds</p>
Q34)	<p>(a) The gap would become narrow. The brick gained heat from the sun and expanded.</p> <p>(b) As the amount of time the brick get heated up increases, the temperature of the brick also increases.</p> <p>(c) A</p>
Q35)	<p>(a) Flexibility</p> <p>(b) Amount of weight placed on the material</p> <p>(c) S, because distance for material S was the lowest. S is the least flexible and will be able to hold the potted plant without bending.</p>
Q36)	<p>(a) Circulatory system.</p> <p>(b) X: digested food Y: undigested food</p> <p>(c) Mouth, stomach and small intestine.</p>
Q37)	<p>(a) (i) ← (ii) →</p> <p>(b) The poles of the magnet A and B in ball Q and the base that are facing each other were like poles. Since like poles repel the toy ball was able to float.</p> <p>(c) The ball will drop</p>
Q38)	<p>(a) Mater occupies space.</p> <p>(b) Liquid Solid</p> <p>(c) 2</p> <p>(d) The grapes have a definite shape thus they will not be able to take the shape of the straw and go up to the straw.</p>
Q39)	<p>(a) Equal to 10 cm</p> <p>(b) Object X has a definite volume.</p> <p>(c) Air in bottle A can escape so water can enter to occupy the space previously occupied by the air.</p>

Q40)	<p>Object 1: C</p> <p>Reason: the unlike poles of magnet A and C were facing each other.</p> <p>Unlike poles attracts, thus magnet A was able to pick up magnet C</p> <p>Object 2: Iron bar.</p> <p>Reason: Magnet A was able to attract the iron bar as the Iron bar is a magnetic object, it is made of a magnetic material.</p>
Q41)	<p>(a) Plastic cup</p> <p>Plastic cup</p> <p>(b) The hot drink will lose heat faster to the surrounding causing the temperature to decrease faster.</p> <p>(c) Metal, it is a better conductor of heat, so more heat could be conducted from the surrounding to the food.</p>

