



PEI HWA PRESBYTERIAN PRIMARY SCHOOL

Mini Test 1

PRIMARY 4

SCIENCE

2<sup>nd</sup> March 2017

Name: \_\_\_\_\_ ( )

Class: Primary 4 Teamwork \_\_\_\_\_

Total time: 30mins

**INSTRUCTIONS TO CANDIDATES**

1. Write your Name, Class and Register No. in the spaces provided above.
2. DO NOT turn over this page until you are told to do so.
3. Follow all instructions carefully.
4. Answer all questions.
5. Write all your answers in this booklet.

Marks (Booklet A) :	12
Marks (Booklet B) :	8
Total Marks (Booklets A & B) :	20

This booklet consists of 8 printed pages, excluding the cover page.

**Section A (12 marks)**

For each question from 1 to 8, four options are given. One of them is the correct answer. Make your choice (1, 2, 3 or 4) and write your answer in the brackets provided.

1. Study the classification table below.

Items made of magnetic metals	Items made of non-magnetic metals
iron bar	gold coin
aluminium foil	silver bracelet
steel screw	copper wire

Which of the above items has been placed in the wrong group?

- (1) gold coin
- (2) steel screw
- (3) copper wire
- (4) aluminium foil

(      )

2. A bar magnet broke into two pieces when it dropped on the floor.



Which diagram below shows the correct poles of the broken pieces of the magnet?

- (1)
- (2)
- (3)
- (4)

(      )

3. Candy has a metal board and a metal disc. The notice could not stay on the metal board. So, she uses the metal disc to hold it on the metal board as shown below.

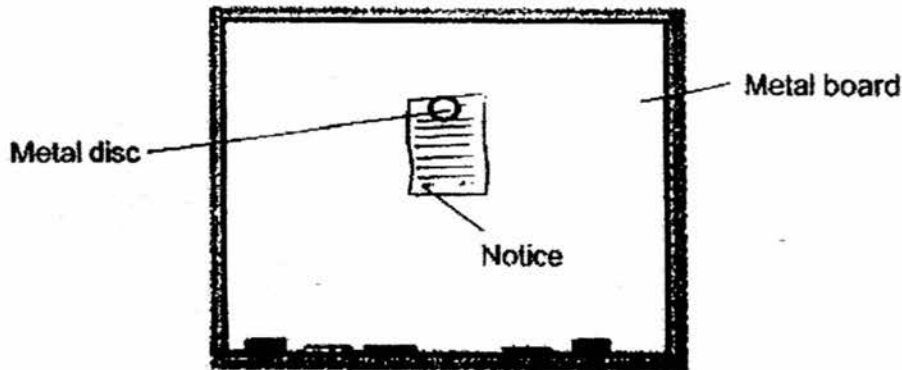

Which of the following statement best explain why the metal disc could hold the notice on the metal board?

- (1) The metal disc is a magnet and it is attracted to the metal board.
- (2) The notice is a magnet and the metal disc is attached to the notice.
- (3) The metal disc and the metal board are both made of non-magnetic materials.
- (4) The metal board is a magnet and the metal disc is made of a non-magnetic material.

( )

4. The set up below shows an electromagnet. The electromagnet can pick up 4 staples from a plate of staples as shown below.

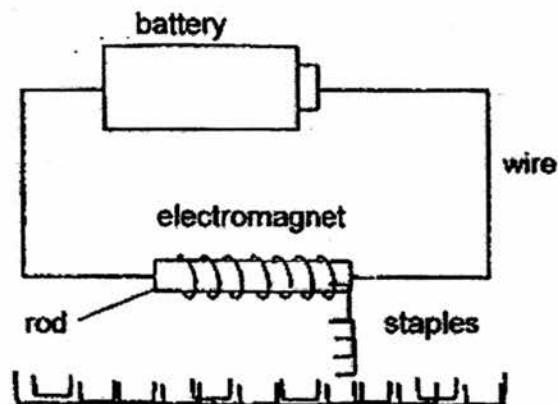

Tina wanted the electromagnet to pick up more metal staples. What should she do?

- (1) Use a bigger size rod
- (2) Increase the length of wire
- (3) Increase the number of rod
- (4) Increase the number of batteries

( )

5. Sandy was trying to make a temporary magnet using a bar magnet and an iron nail. Which of the following shows the correct stroking method?

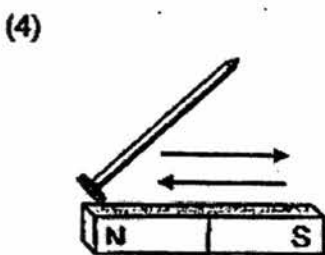
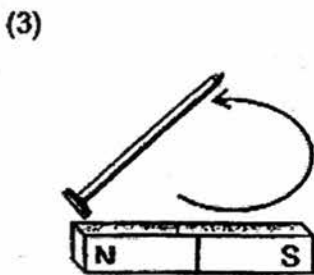
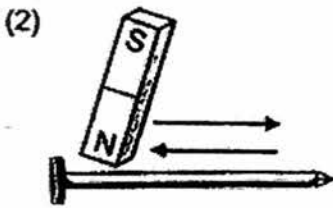
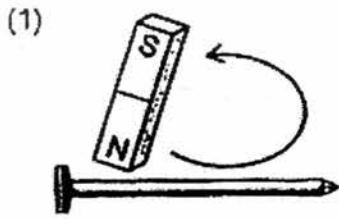

( )

6. Mr Lim taped two bar magnets and placed a compass in between them on a table as shown below.

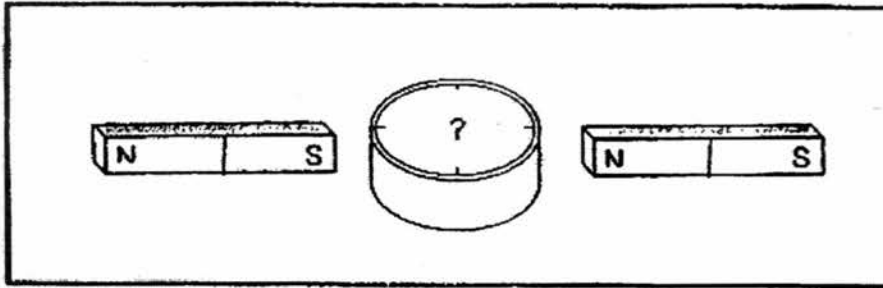

Which of the compass below shows the correct directions of the needles?

(1)

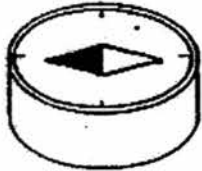

(2)

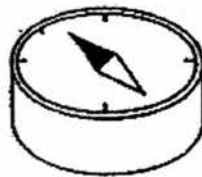

(3)

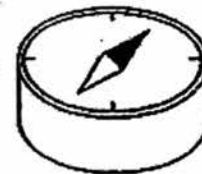

(4)

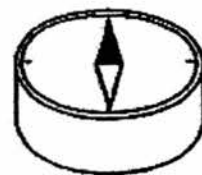

( )

**Section B (8 marks)**

Read questions 7 to 10 carefully. Write your answers in the spaces provided.

The number of marks available is shown in brackets [ ] at the end of each question or part question.

7. The diagram below shows what happens after three magnets are suspended from a pole. The arrows show the magnets movement. The poles of Magnet B are as labelled below.

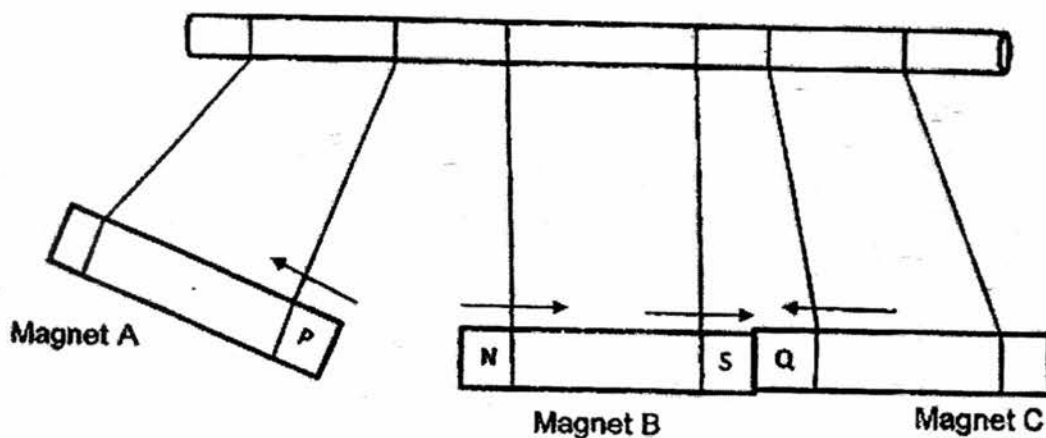

Identify the poles of P and Q.

[1]

(a) Pole P: \_\_\_\_\_

(b) Pole Q: \_\_\_\_\_

- (c) Explain what would happen to both Magnet A and Magnet C when Pole P of Magnet A is brought near to Pole Q of Magnet C.

[1]

---

---

8. Paul had four button magnets of different sizes as shown below.



He put the button magnets, one at a time, into a tray full of paper clips to see how many paper clips would be attracted to each magnet. He recorded the results in the table below.

Magnets	Number of paper clips attracted
W	4
X	5
Y	10
Z	6

(a) Based on his results, arrange in order, the strength of the magnets, from the strongest to the weakest by writing the letters, W, X, Y or Z in the correct boxes below. [1]

--	--	--	--

Strongest  $\longrightarrow$  Weakest

(b) Based on his experiment, what can he conclude in terms of the size of the magnet and the strength of the magnet? [1]

---

---

9. Dave set up an experiment using a new battery as shown in the diagram below.

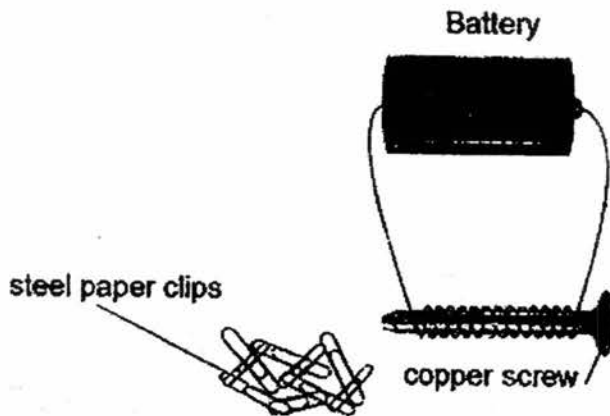

(a) Dave placed some steel paper clips close to the screw, but the screw did not attract the steel paper clips. Explain why. [1]

---

---

(b) What should Dave change in this experiment if he wants to attract the steel paper clips? [1]

---

---



10. When the iron bar and the steel bar were brought near to the iron filings in a dish, none of the iron filings moved.

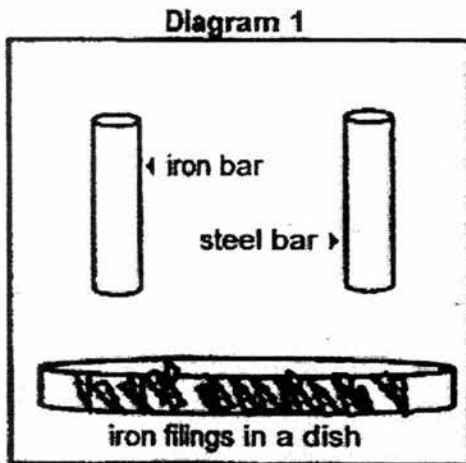

When a magnet was placed over the iron bar and the steel bar, the iron filings moved as shown in the diagram below.

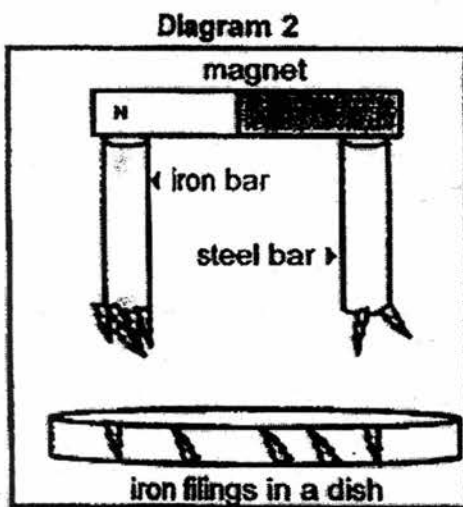

- (a) Based on the information above, explain what had happened to the iron and steel bar that resulted in the observation in Diagram 2. [1]

---

---

- (b) State one difference about the two bars used in the experiment in terms of their magnetic strength. [1]

---

---

THE END



EXAM PAPER 2017 (P4)

SCHOOL : PEI HWA

SUBJECT : SCIENCE

TERM : CA1

ORDER CALL :

Q1	Q2	Q3	Q4	Q5	Q6				
4	2	1	4	1	1				

7)a)North    b)North

c)As P and Q poles that are facing each are like poles, they will repel each other.

8)a)Y , Z , X , W

b)Paul can conclude that the strength of a magnet does not depend on what size it is.

9)a)Copper is a non-magnetic material so it cannot be turned into a temporary magnet or a magnet.

b)He should change the screw to a magnetic material such as iron, steel, nickel or col bat if he wants to attract steel paper clips.

10)a)The iron bar and steel bar were magnetised so they would be able to attract some iron filings.

b)The iron bar is stronger than the steel bar base on its magnetic strength.

