



Anglo-Chinese School (Primary)

P4 SCIENCE 2008

SA1 (MID-YEAR) EXAMINATION

BOOKLET A

Name: _____ () Class: Primary 4 ___

Date: 9 May 2008

Duration of paper: 1h 45 min

Parent's/Guardian's signature

THIS BOOKLET CONTAINS 21 PAGES.
DO NOT OPEN THIS BOOKLET UNTIL YOU ARE TOLD TO DO SO.
FOLLOW ALL INSTRUCTIONS CAREFULLY.

PART I

For each of the following questions from 1 to 30, four options are given. One of them is the correct answer. Make your choice (1, 2, 3 or 4). Shade the correct oval (1, 2, 3 or 4) on the Optical Answer Sheet. (30 x 2 marks)

- 1 The diagram below shows how some animals are classified based on certain characteristics, P and Q.

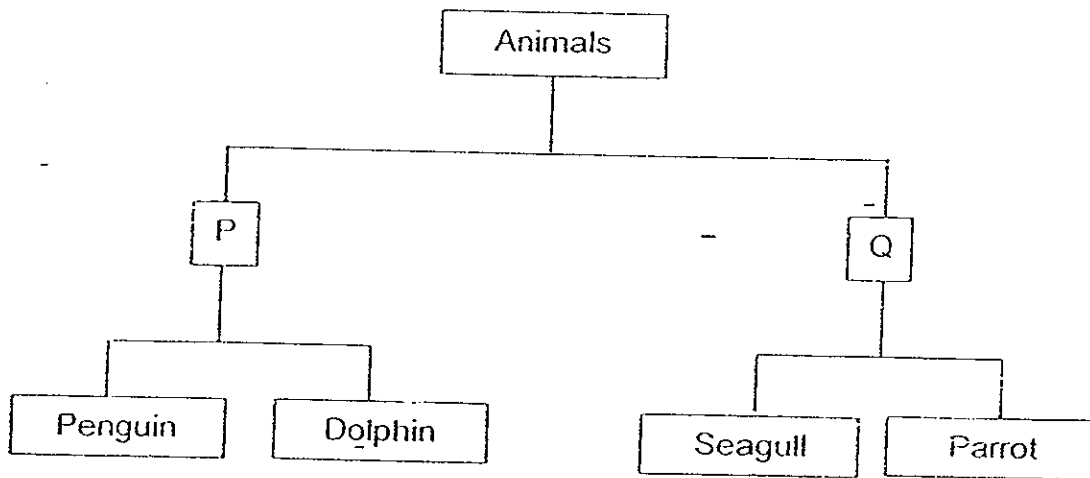

Which one of the following is a suitable heading for P and Q?

	P	Q
(1)	Give birth to young alive	Reproduce by laying eggs
(2)	Unable to fly	Able to fly
(3)	Covered with hair	Covered with feathers
(4)	Have no legs	Have two legs

2 Which one of the following shows the correct life cycle of a plant?

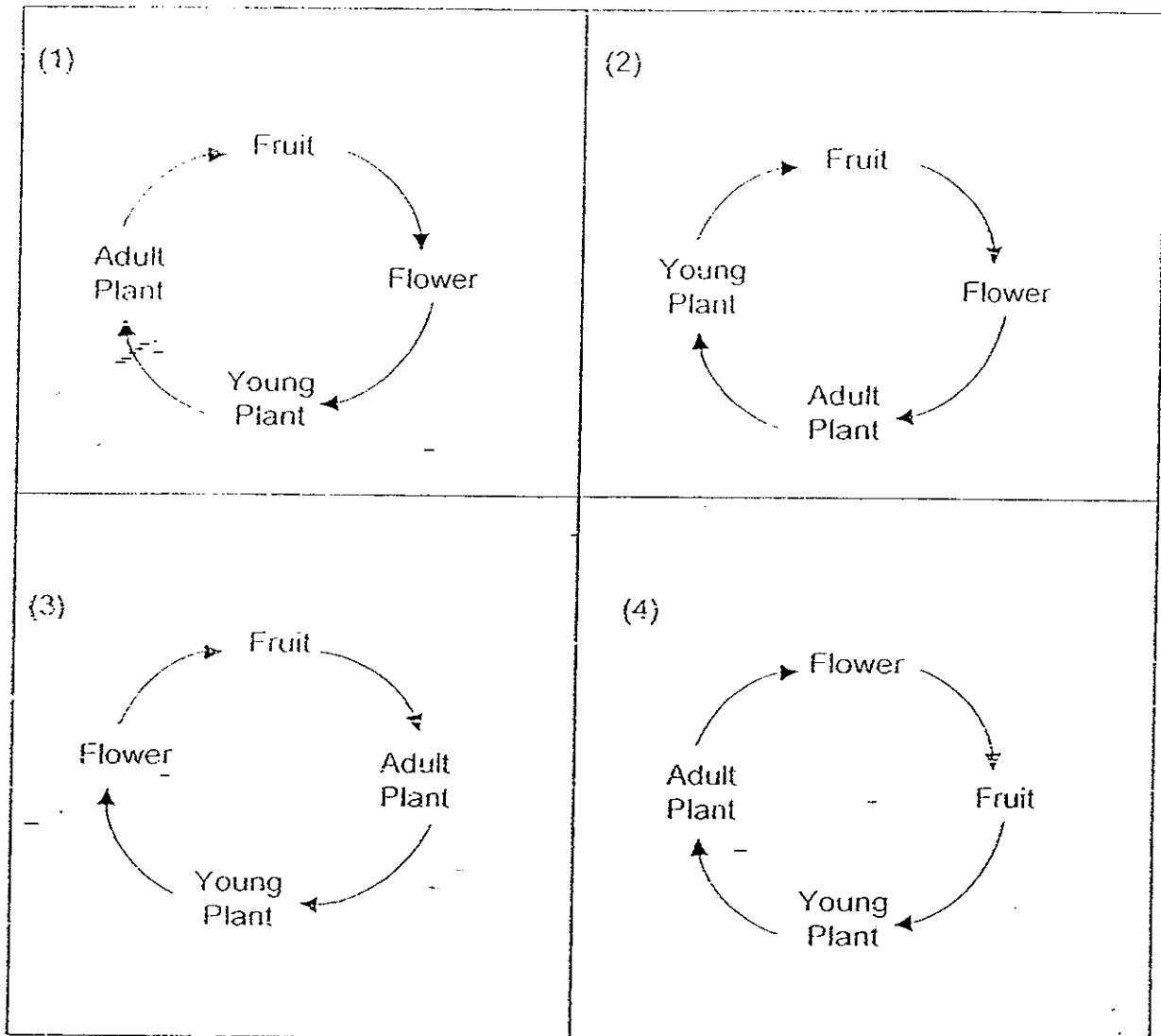

3 Which one of the following statements is incorrect?

- (1) Burning fuel is one way to produce heat.
- (2) Heat is a form of energy that makes things hot.
- (3) Heat is a measure of how hot or how cold a body is.
- (4) Heat travels from an object/region of higher temperature to an object/region of lower temperature.

4 The following diagram shows the human digestive system.

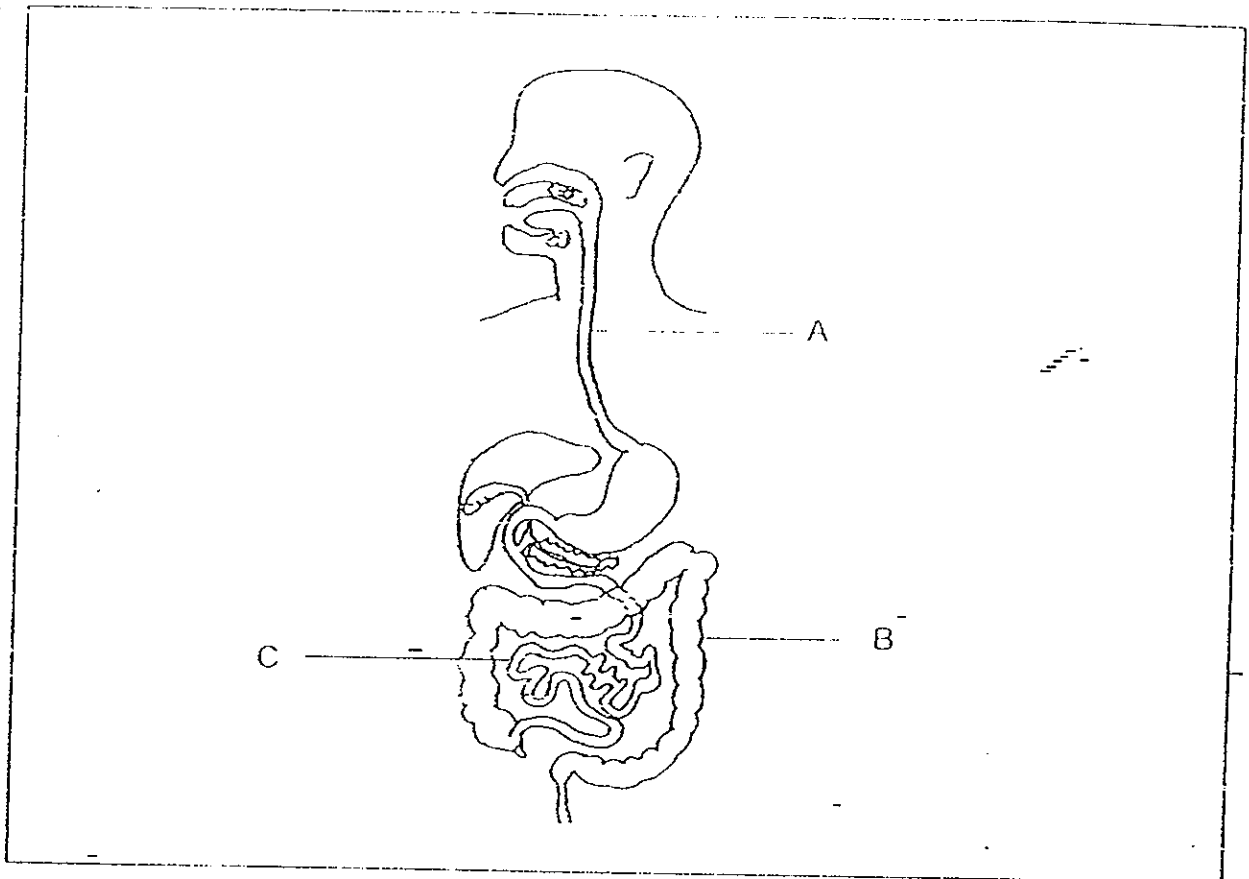

Which one of the following are the correct labels for A, B and C?

	A	B	C
(1)	Gullet	Stomach	Small Intestine
(2)	Windpipe	Large Intestine	Small Intestine
(3)	Gullet	Small intestine	Large Intestine
(4)	Gullet	Large Intestine	Small Intestine

- 5 Peter attached 4 iron nails, P, Q, R and S, to the metal rod using wax. He lit a candle and held it near the rod at the position as shown in the diagram. He wanted to find out the order in which the nails would drop off the metal rod.

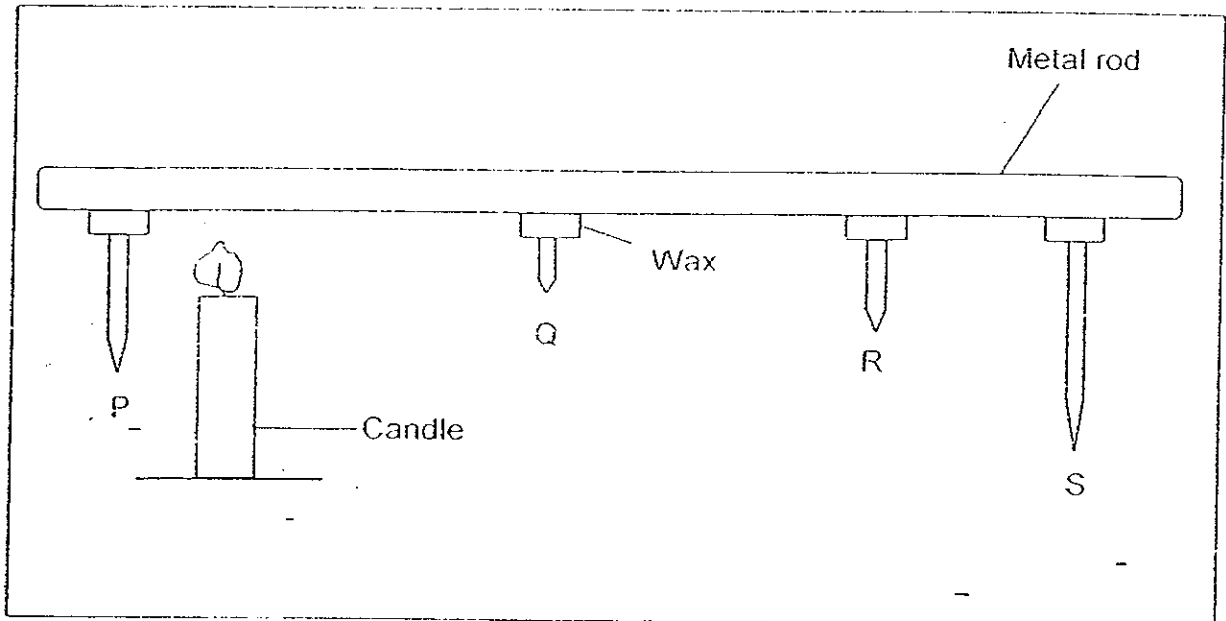

Why was the experiment not a fair test?

- (1) The same amount of wax was used.
- (2) The sizes of the 4 iron nails were not the same.
- (3) The 4 iron nails were made of the same material.
- (4) The distances between the candle and the 4 nails were different.

- 6 3 identical beakers containing different amounts of boiling water were placed in 3 identical containers at the same time. The containers were then sealed with stoppers to ensure that they were air-tight. Each stopper had a thermometer inserted into it.

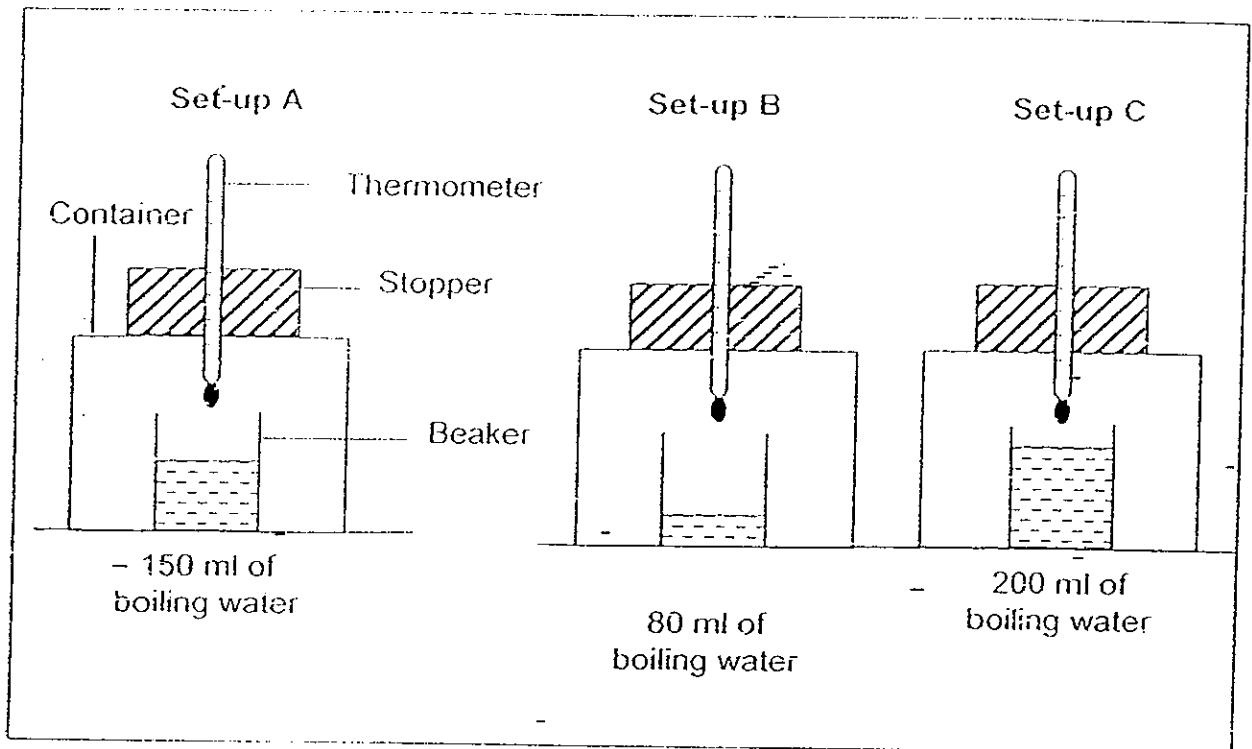

After 2 minutes, the temperatures of the air in the 3 containers were taken at the same time. The containers were then ranked from the one having the lowest temperature to the one having the highest temperature. Which one of the following shows the correct order?

- (1) A, C, B
- (2) C, B, A
- (3) B, A, C
- (4) C, A, B

Answer Questions 7 and 8 based on the diagram below.

Jamie placed 2 spoons of the same size into a glass of hot water at the same time.

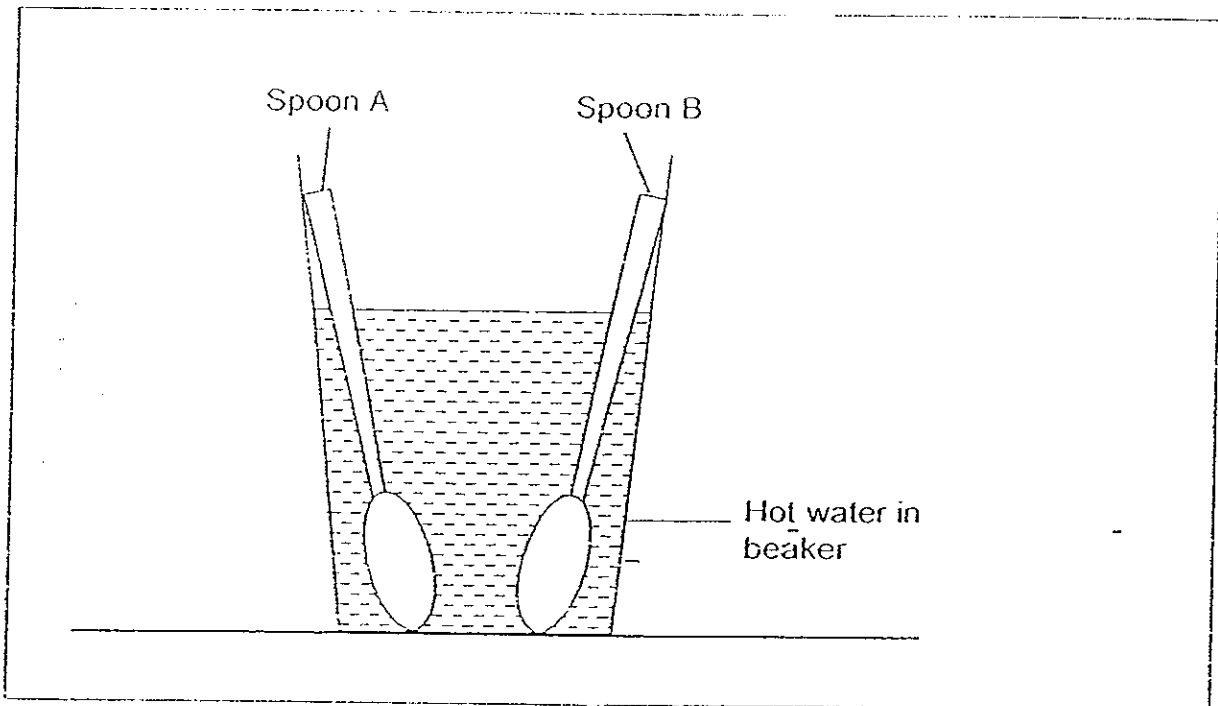

- 7 After 3 minutes, she held Spoon A with her left hand and Spoon B with her right hand. She felt that Spoon B was hotter than Spoon A.

Which one of the following best explains her conclusion?

- (1) Spoon B is a better conductor of heat than Spoon A.
 - (2) Spoon A is made of a stronger material than Spoon B.
 - (3) The two spoons were placed in different positions of the beaker.
 - (4) Spoon A allows heat to flow through more easily than Spoon B.
- 8 What is the aim of Jamie's experiment?
- (1) To find out if water is a good conductor of heat.
 - (2) To find out the strength of the materials of the spoons.
 - (3) To find out which material is a better conductor of heat.
 - (4) To find out which of the five senses is used in the experiment.

- 9 The diagram below shows a metal ball and ring apparatus. The metal ball could not pass through the ring completely.

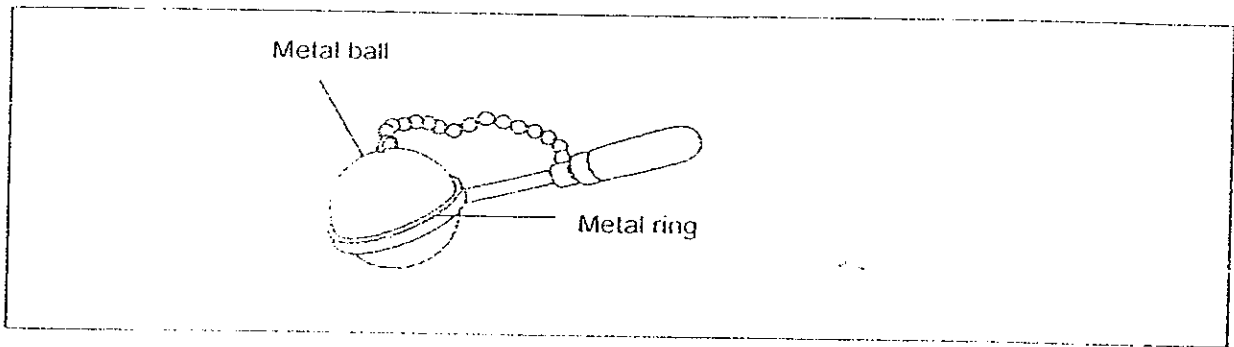

Which one of the following would enable the ball to pass through the ring?

- (1) Heat the metal ball over a strong flame.
- (2) Heat the metal ring over a strong flame.
- (3) Put both the metal ball and ring in cold water
- (4) Heat both the metal ball and ring over a strong flame

- 10 Observe the following diagram, which shows the changes of states of matter.

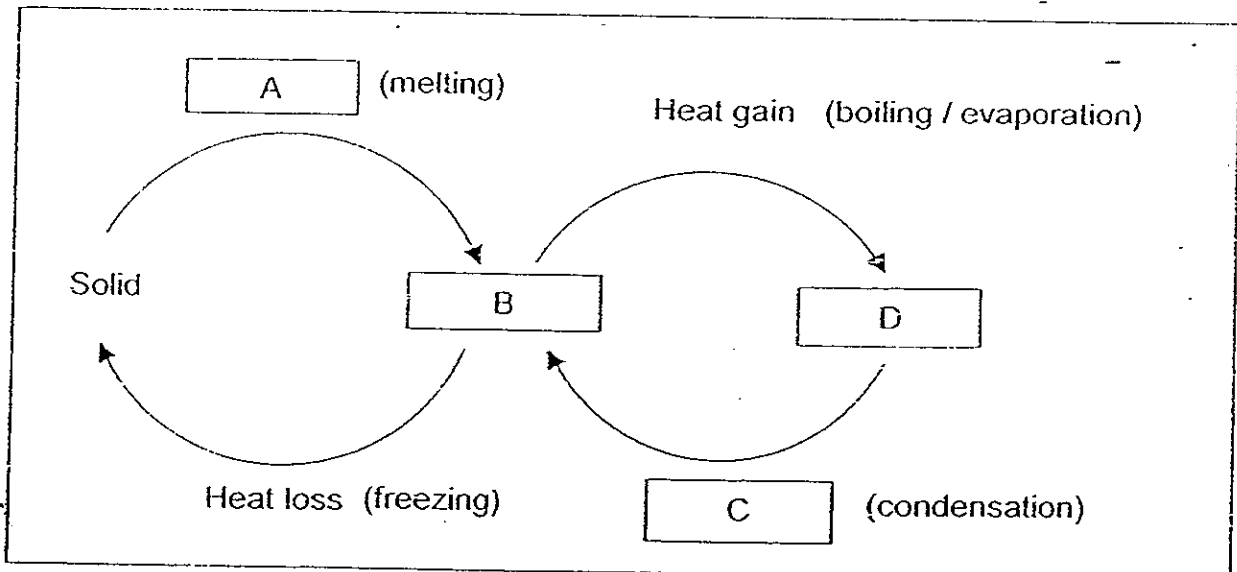

Which one of the following is correct?

	A	B	C	D
(1)	Heat gain	Liquid	Heat gain	Gas
(2)	Heat loss	Gas	Heat loss	Liquid
(3)	Heat loss	Gas	Heat gain	Liquid
(4)	Heat gain	Liquid	Heat loss	Gas

- 11 The table below shows some of the parts of the human respiratory and skeletal systems respectively.

Respiratory System	Skeletal System
Nose	Ribs
Windpipe	Backbone
X	Y

What could X and Y possibly be?

	X	Y
(1)	Mouth	Heart
(2)	Lungs	Skull
(3)	Lungs	Gullet
(4)	Mouth	Skin

- 12 A glass tube containing an ink drop was inserted into a flask.

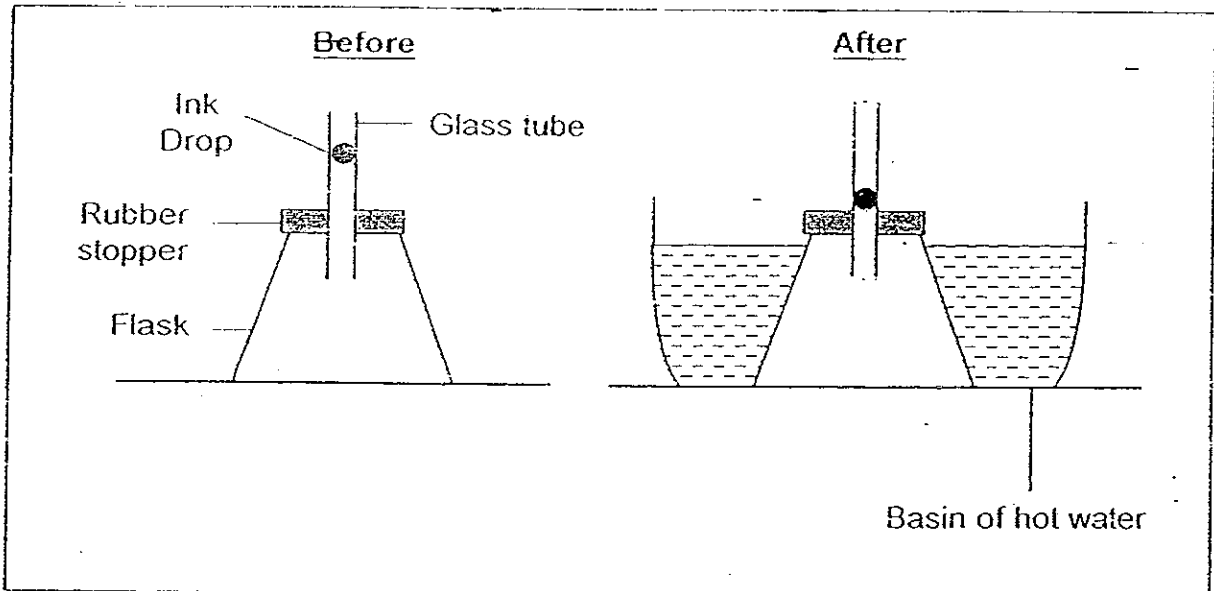

When the set-up was put into a basin of hot water, the ink drop moved down slightly. What could have caused the change?

- (1) The hot water caused the flask to expand.
- (2) The air in the flask gained heat and expanded.
- (3) The hot water in the basin lost heat and contracted.
- (4) Both the water and the air expanded when it is left to cool.

- 13 Three similar sized containers, A, B and C, were made of different materials. They were filled with the same amount of water having a temperature of 50°C . The water was allowed to cool down to 20°C . The table shows the time taken for the temperature of the water in each container to drop to 20°C .

	Container A	Container B	Container C
Time taken for water to cool down to 20°C (h)	2	1	3

Which one of the following graphs shows the correct results?

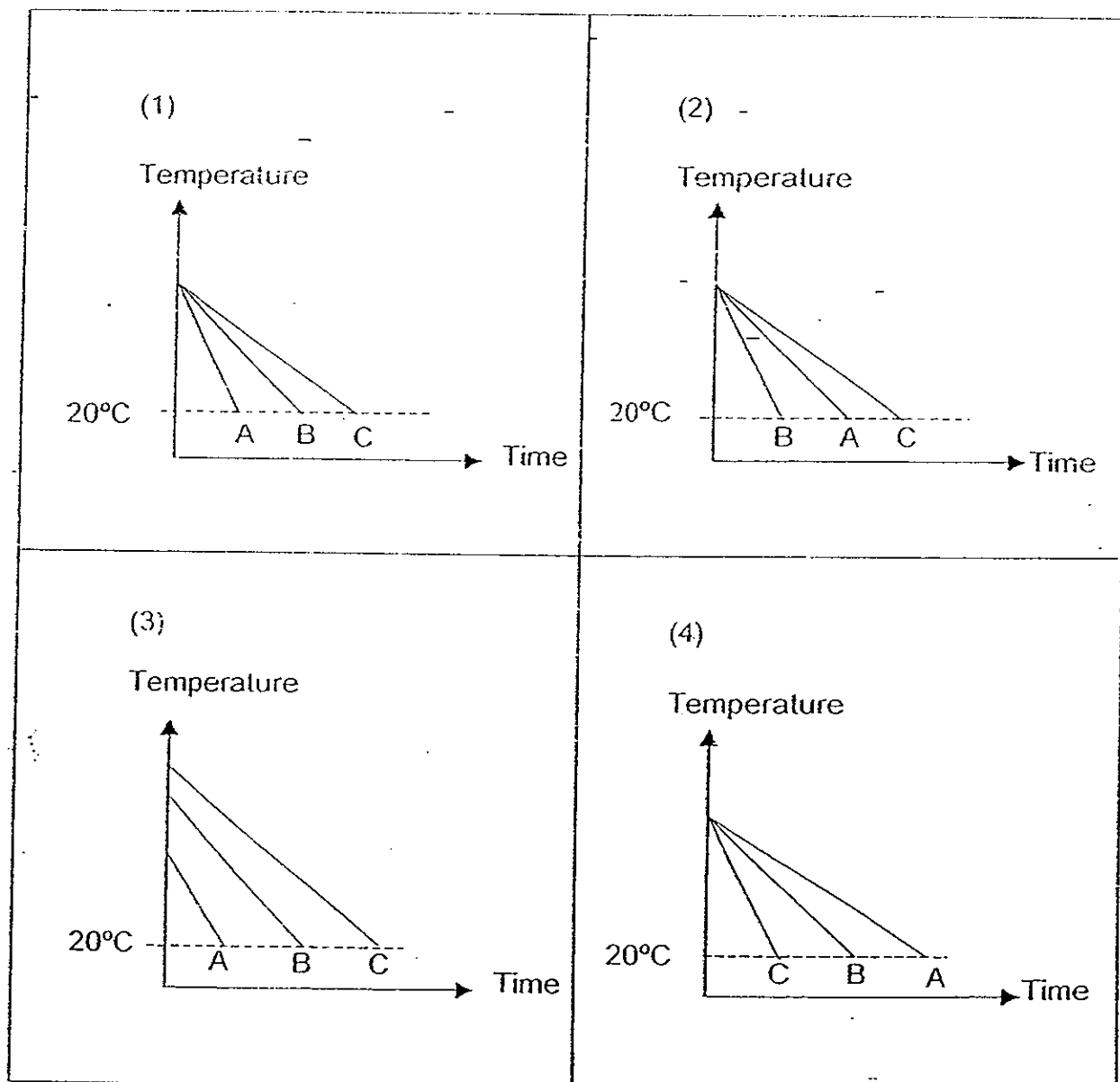

- 14 The table below shows the functions of various body systems. Which one of the following is incorrect?

	System	Function
(1)	Digestive	Breaks down food into simpler substances for the body to absorb.
(2)	Respiratory	Takes in oxygen and removes carbon dioxide from the body.
(3)	Muscular	Supports the body and gives it its shape.
(4)	Skeletal	Protects the delicate organs in the body.

- 15 Diagram A shows the life cycle of Insect A while Diagram B shows the life cycle of Insect B.

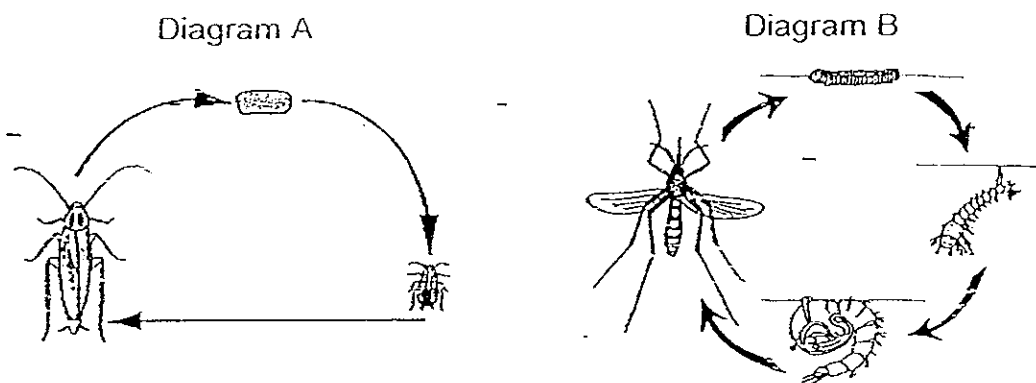

Rachel made the following statements based on the diagrams above.

- A. The life cycle of Insect A has 3 stages but the life cycle of Insect B has 4 stages.
- B. The young of Insect A resembles its adult but the young of Insect B does not.
- C. Both Insect A and Insect B can fly.
- D. The adults of Insects A and B have 6 legs each.

Which of the above statements are true based only on the observation of the diagram above?

- (1) A and C only
- (2) B and C only
- (3) A, B and D only
- (4) All of the above

- 16 The diagram below shows a wooden block, which was left standing in the middle of an open field for 2 hours. During the 2 hours, it was found that the position of the shadow cast by the wooden block remained unchanged.

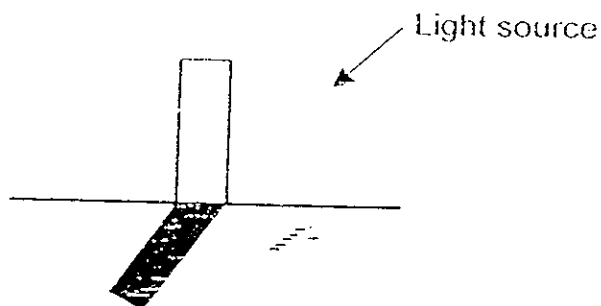

Which one of the following about the light source and the time duration is most likely true?

	Light source	Time duration
(1)	Sun	Between 7 a.m. to 9 a.m.
(2)	Sun	Between 11 a.m. to 1 p.m.
(3)	Lamp post	Between 3 p.m. to 5 p.m.
(4)	Lamp post	Between 1 a.m. to 3 a.m.

- 17 The table below shows how 9 things were classified into 3 different groups, X, Y and Z.

Group X	Group Y	Group Z
Horse	Leather shoe	Metal horseshoe
Goldfish	Coconut juice	Gold ring
Wood pecker	Firewood	Stainless steel pot

Which one of the following sets of 3 additional things can be grouped based on the same classification above?

	X	Y	Z
(1)	Chicken	Wooden plate	Silver spoon
(2)	Fisherman	Fish tank	Metal hook
(3)	Water hyacinth	Water pump	Pebble
(4)	Sparrow	paper	worm

18 Four bar magnets are attracted to one another as shown below.

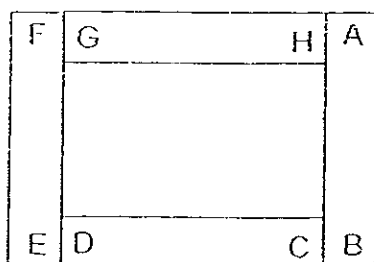

Which one of the following shows the likely results when two of the magnets are put together end to end?

(1)		Ends that are placed together	Attract	Repel
	(i)	A and D	√	-
	(ii)	B and E		√
(2)		Ends that are placed together	Attract	Repel
	(i)	A and F	√	
	(ii)	C and G	√	
(3)		Ends that are placed together	Attract	Repel
	(i)	C and E		√
	(ii)	D and G	√	
(4)		Ends that are placed together	Attract	Repel
	(i)	C and F		√
	(ii)	E and H	√	

- 19 Carmen conducted an experiment using 3 objects, X, Y and Z. She used 2 different objects at any one time and rubbed them against each other. She recorded her observations as shown below.

Observation:

- X has scratches but not Y when the two of them were rubbed against each other.
- Y has scratches but not Z when the two of them were rubbed against each other.

What was the aim of her experiment?

- (1) To find out which object is the hardest.
- (2) To find out which object is the strongest.
- (3) To find out which object expands the most.
- (4) To find out which object is the most flexible.

- 20 Which of the following are examples of things that give out its own light?

A: A firefly

B: A mirror

C: The sun

D: The moon

- (1) A and C only
- (2) B and C only
- (3) A, B and C only
- (4) A, B and D only

21 In Set-up A, an ice-cream cone was placed on a glass pane directly under a lighted torch in a dark room as shown below.

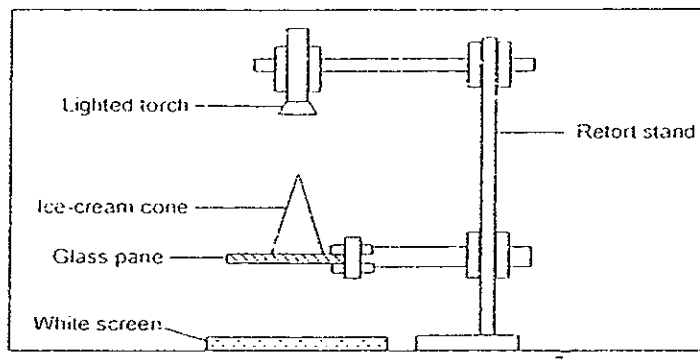

Set-up A

The lighted torch and the screen were then re-positioned twice as shown in Set-up B and Set-up C.

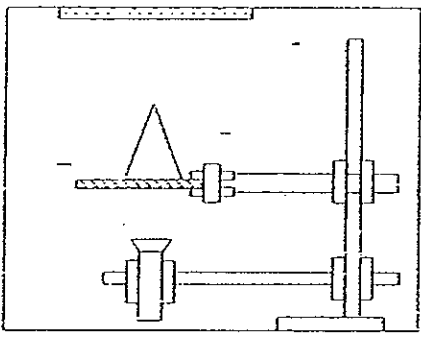

Set-up B

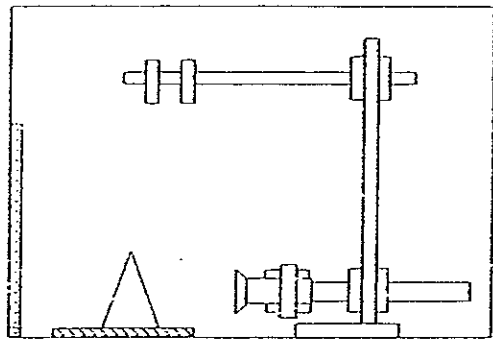

Set-up C

Which one of the following shows the likely shadows of the cone that were cast on the white screens in the 3 set-ups?

	Set-up A	Set-up B	Set-up C
(1)			
(2)			
(3)			
(4)			

- 22 8 blocks of the same size but made of different materials are formed in a cross-like arrangement as shown below. A metallic star was hung in the centre.

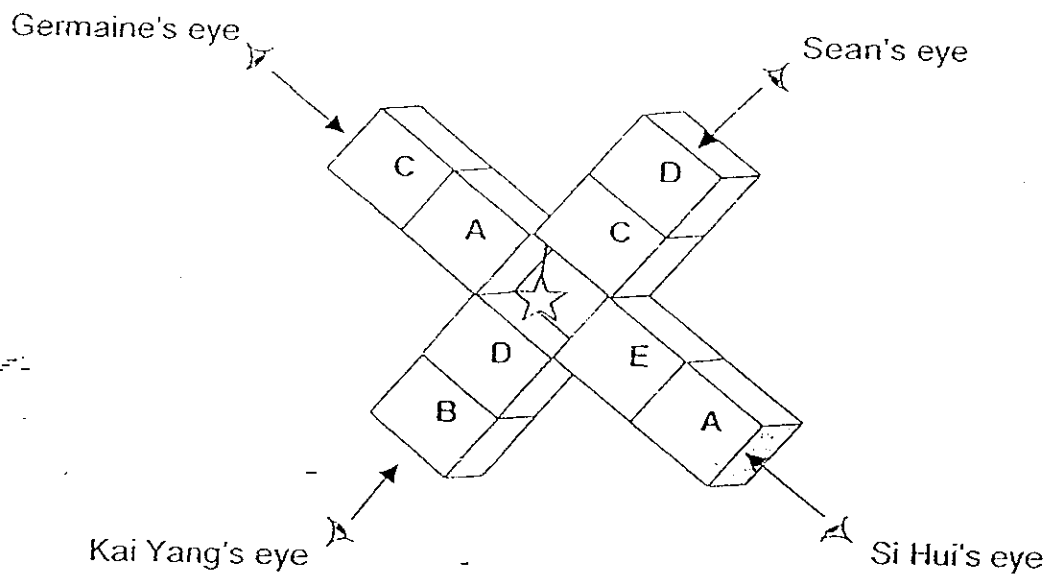

If you are told that only Germaine and Si Hui could see the metallic star, which one of the following correctly shows the material each block is made of?

	Material A	Material B	Material C	Material D	Material E
(1)	Clear glass	Frosted glass	Clear plastic	Clear coloured plastic	Frosted glass
(2)	Clear coloured plastic	Clear plastic	Clear glass	Wood	Frosted glass
(3)	Clear coloured plastic	Brick	Wood	Metal	Clear plastic
(4)	Frosted glass	Metal	Clear coloured plastic	Clear plastic	Brick

- 23 Peter carried out an experiment as shown below to find out how the amount of light that passes through the curtain varies with the distance between the curtain and the datalogger. He kept the torch and the curtain at the same positions but moved the datalogger to 3 different points, A, B and C. He then measured the amount of light that passed through the curtain each time he moved the datalogger.

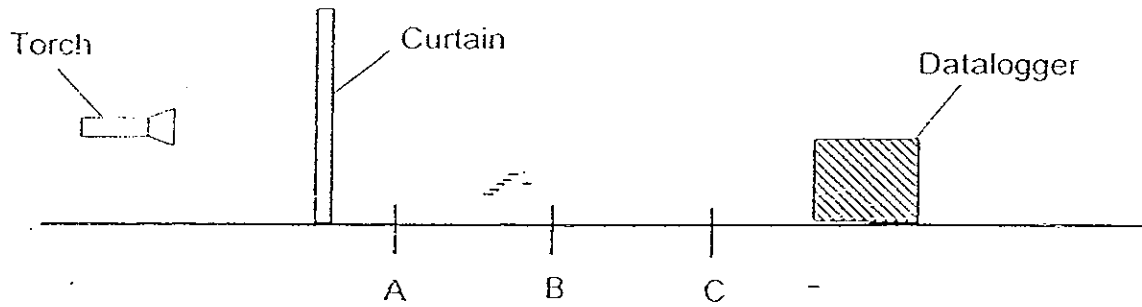

Which one of the following graphs correctly shows the likely data measured by the datalogger when Peter moved the datalogger to the 3 points?

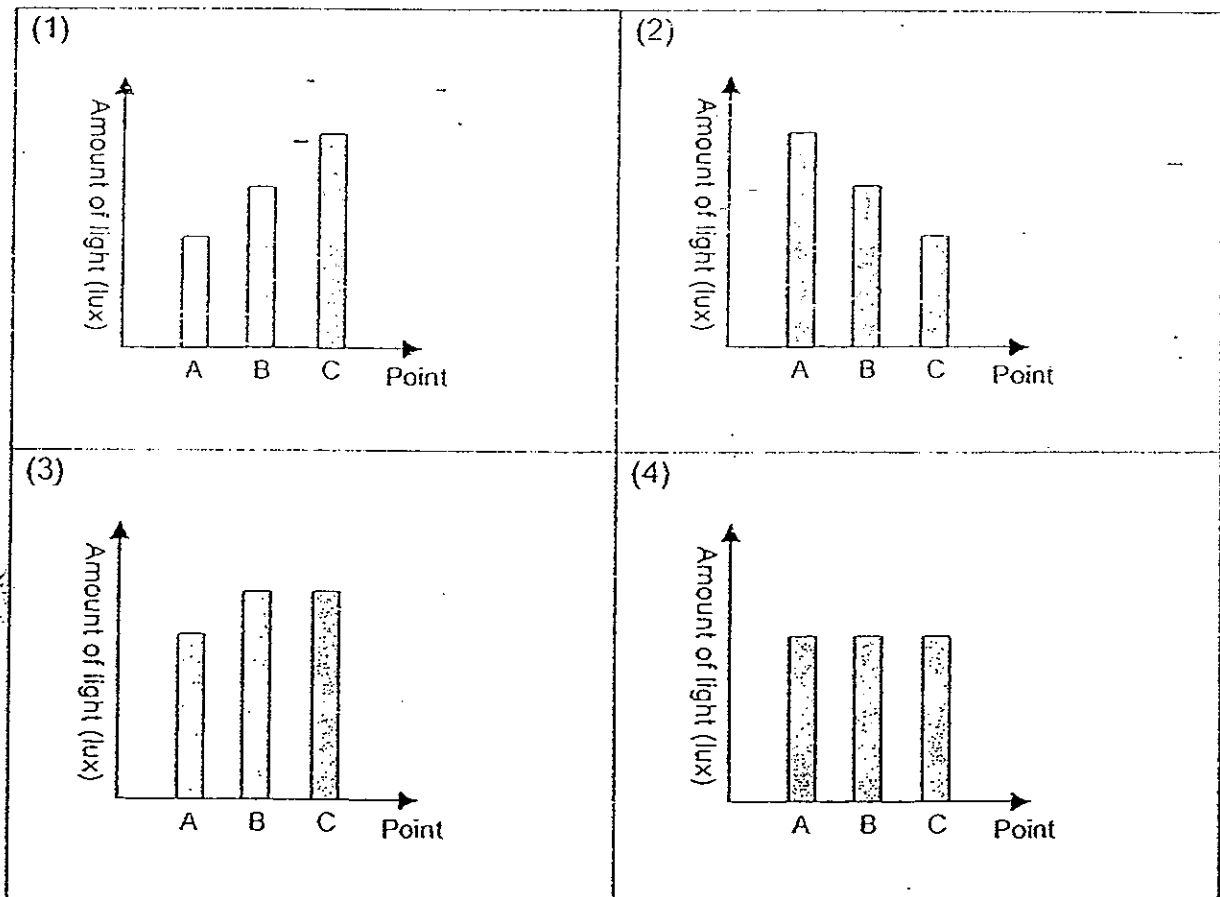

- 24 Allan wanted to find out if light travels in a straight line. He carried out an experiment using set-ups, A and B, as shown in the diagram below.

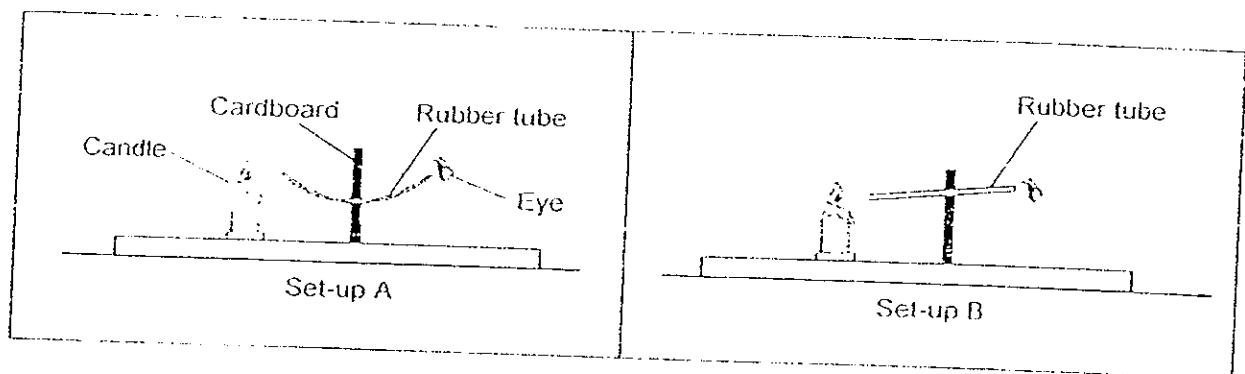

Which one of the following variables was changed in this experiment?

- (1) Size of the candles
 - (2) Shape of the rubber tube
 - (3) Material of the cardboard
 - (4) Location of the experiment
- 25 Charlotte placed a potted plant near the window and noticed that it grew taller than before and bent towards the direction of the sunlight after 2 weeks.

Based on her observation given above, what are the two characteristics of a living thing that were demonstrated in the experiment above?

- (1) Living things grow and die.
- (2) Living things grow and respond to changes.
- (3) Living things reproduce and respond to changes.
- (4) Living things need air, water and food, and reproduce.

- 26 4 different set-ups are shown below. In all the set-ups, similar wooden blocks, similar cardboards and different sizes and shapes of tubes are used. In two of the set-ups, mirrors are attached inside the tubes.

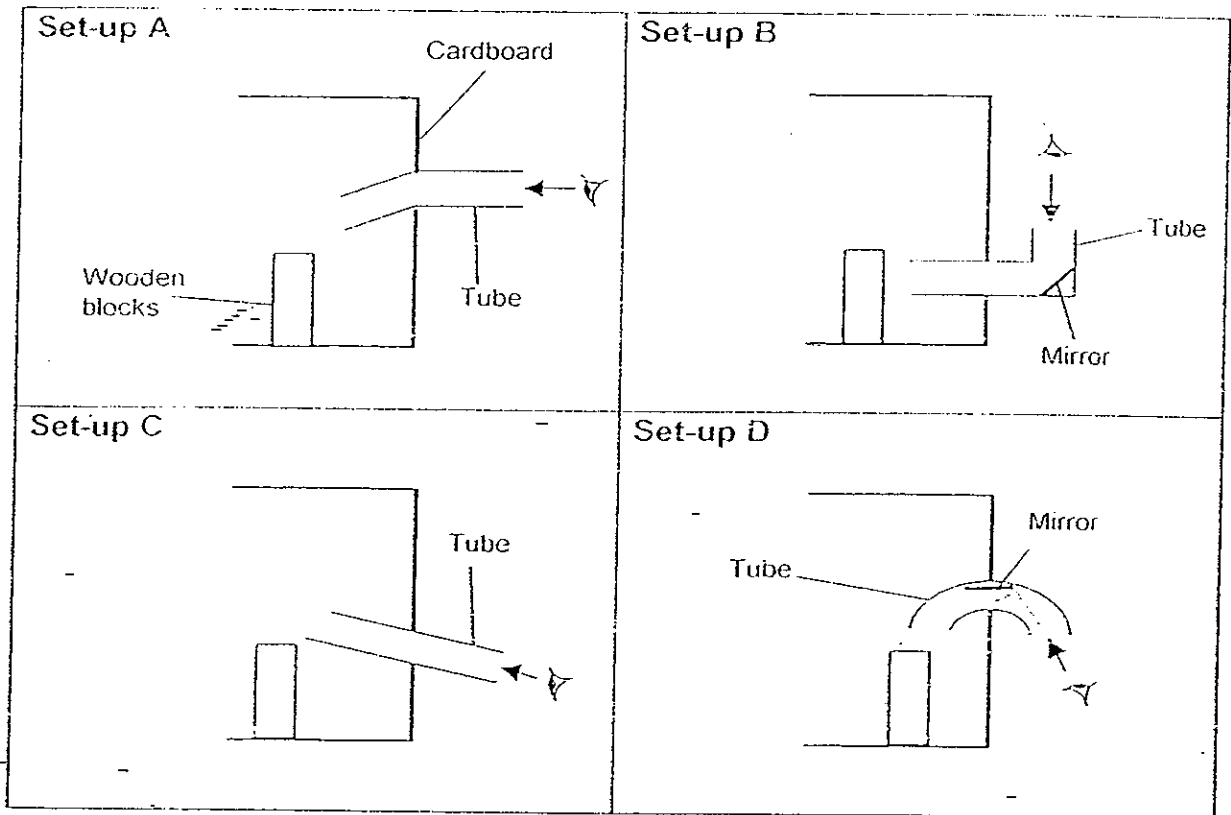

In which of the following set-ups would you be able to see the wooden block at the other side of the cardboard?

- (1) A and C only
- (2) A and D only
- (3) B and C only
- (4) B and D only

- 27 A boy was at a crossroads at 7 p.m. He was deciding on which path, A, B, C or D, to take that would take him to the southern part of the town as shown below.

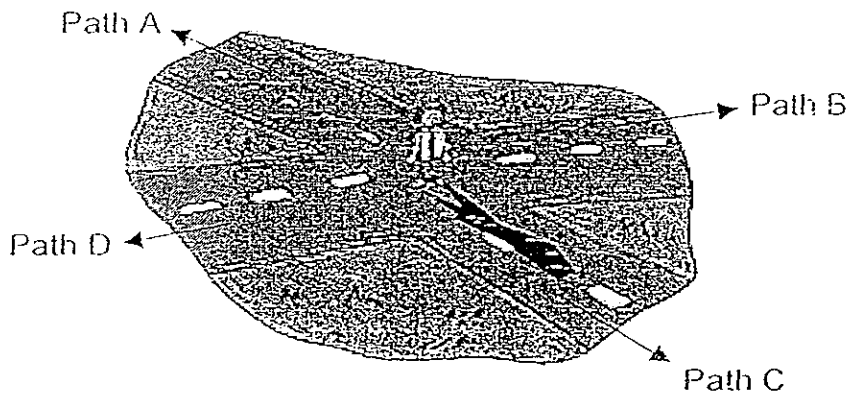

He looked at the direction his shadow was pointing and right away, he knew he could make a decision confidently.

Which one of the following paths would he most likely to choose?

- (1) A
 - (2) B
 - (3) C
 - (4) D
- 28 Devin conducted an experiment on the growth of plants. He planted a plant of the same kind in each of the following set-ups, A, B, C, D and E.

	Set-up A	Set-up B	Set-up C	Set-up D	Set-up E
Time duration of experiment	1 week	2 weeks	1 week	2 weeks	1 week
Location of experiment	Location A	Location A	Location B	Location A	Location B
Amount of water given to the plant every day(ml)	50	50	20	20	20
Amount of fertiliser given to the plant per week(cm^3)	10	10	5	10	10

If he wanted to find out how the amount of water affects the growth of a plant, which two set-ups should he use to conduct a fair test?

- (1) Set-ups A and B
- (2) Set-ups A and D
- (3) Set-ups B and D
- (4) Set-ups C and E

29 The classification chart below shows how some plants can be grouped.

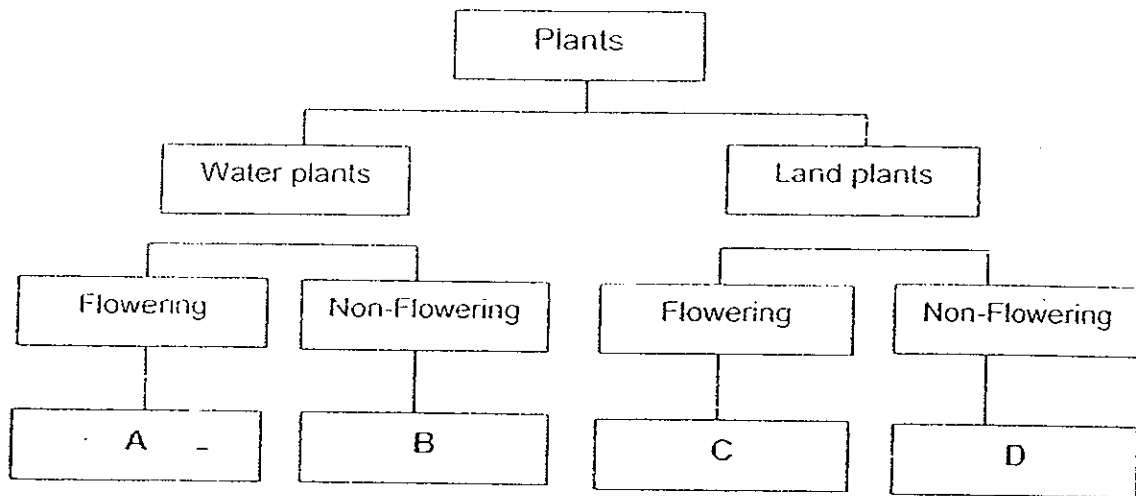

In which box, A, B, C or D, would you place a watermelon?

- (1) A
- (2) B
- (3) C
- (4) D

- 30 The diagram below shows the side view of 3 wooden blocks, A, B and C, of different sizes that were positioned at a distance apart from one another on a tabletop.

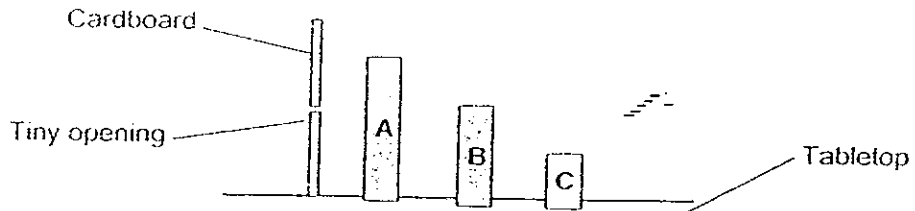

If Justin looked through the opening and he could only see ^{block} Book B, which one of the following is the most likely arrangement of the 3 wooden blocks as seen from the top view?

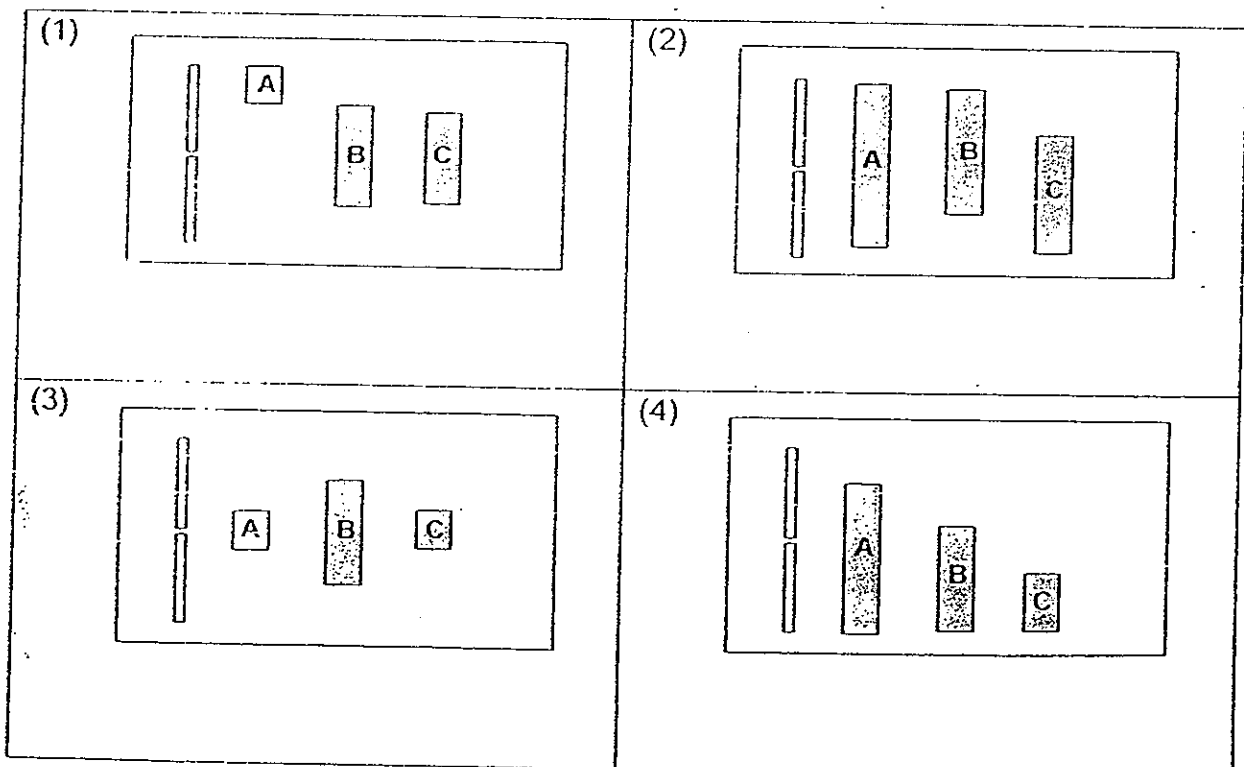

End of Part I. Please go on to Part II.



Anglo-Chinese School (Primary)

P4 SCIENCE 2008

SA1 (MID-YEAR) EXAMINATION

BOOKLET B

Name: _____ () Class: Primary 4 _____

Date: 9 May 2008

Duration of paper: 1h 45 min

	Maximum Marks	Marks Obtained
Section A / Booklet A	60	
Section B / Booklet B	40	
Total	100	

THIS BOOKLET CONTAINS 15 PAGES.

DO NOT OPEN THIS BOOKLET UNTIL YOU ARE TOLD TO DO SO.

FOLLOW ALL INSTRUCTIONS CAREFULLY.

Part II : Answer the following questions in the space(s) provided. [40 marks]

31 Study the diagram of a fish below carefully.

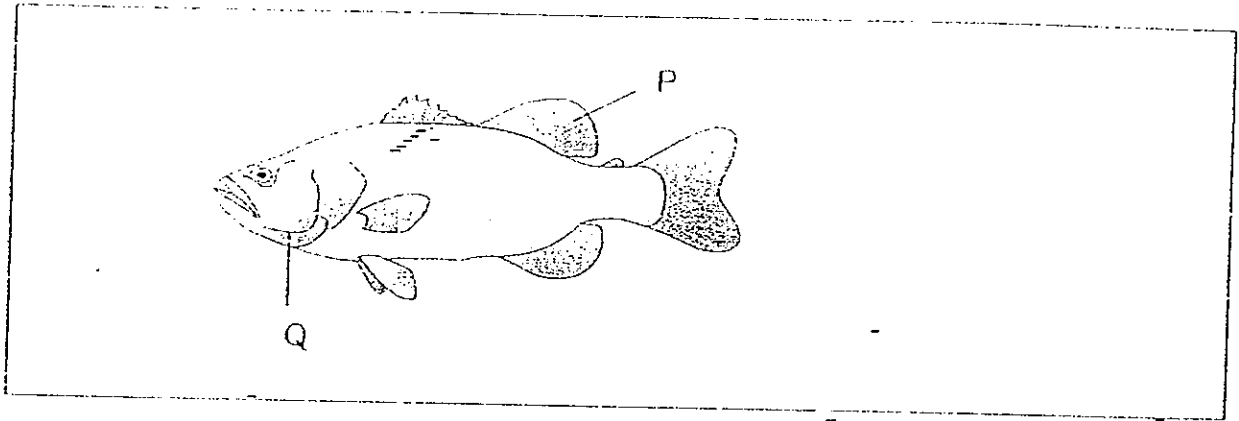

(a) Identify the parts labelled P and Q. [1]

(i) P : _____

(ii) Q : _____

(b) What type of body covering does the fish have? [1]

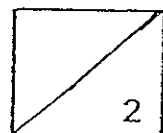

- 32 Matthew heated a beaker of water until it reached its boiling point. He left it boiling for some time. He then left the beaker of boiling water on the table for the next 5 minutes. After that, he added some ice cubes to the water. He used a datalogger to measure the temperature of the water and the result is shown in the graph shown below.

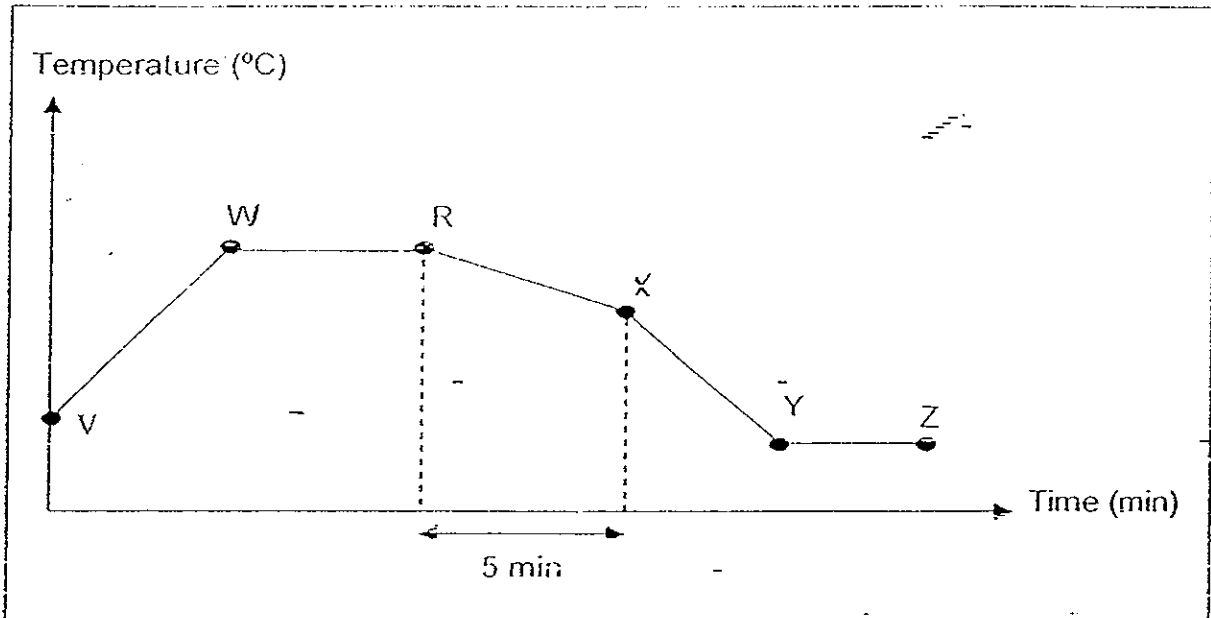

- (a) Which point on the graph shows the temperature of the water when it first reached its boiling point? [1]

- (b) Which point shows the temperature of the water when the ice cubes were put into the beaker of water? [1]

- (c) Which line, RX, XY or YZ, shows that there is no change in the temperature of the water? [1]

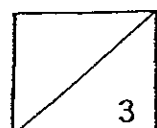

- 33 4 similar sized containers, A, B, C and D, are made of different materials. They contain the same number of ice cubes. In order to melt the ice cubes, the containers were heated at a constant temperature of 70 °C.

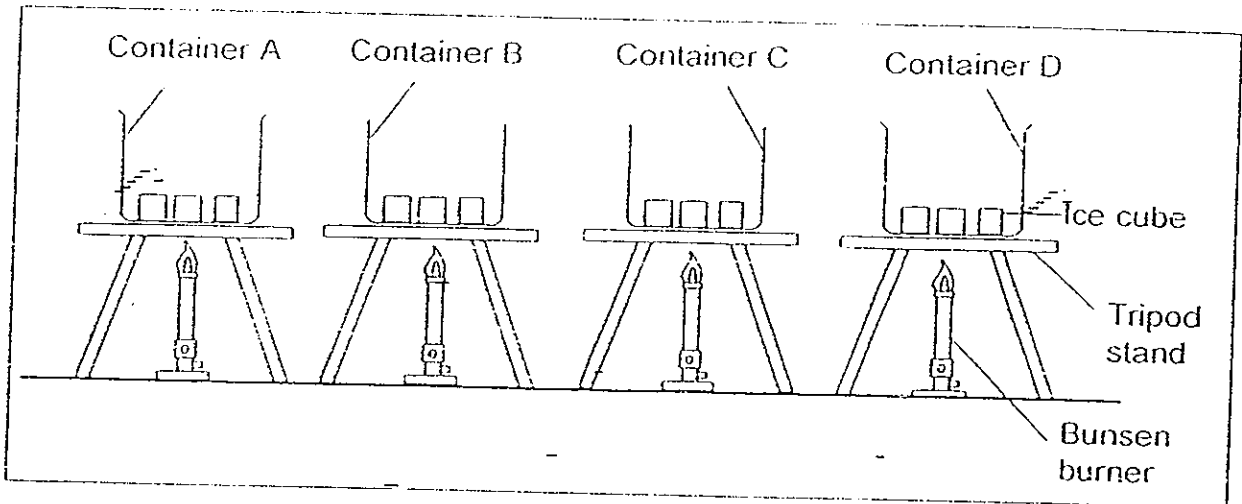

The graph below shows the time taken for the ice cubes to melt completely in containers A, B and C.

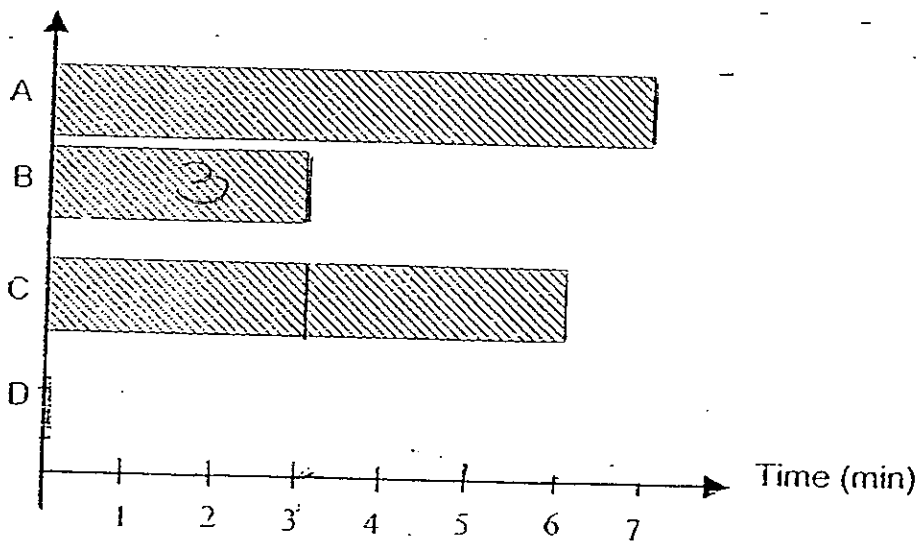

- (a) The ice cubes in Container D took 5 minutes to melt. Draw the bar graph for Container D in the graph above. [1]
- (b) Rank the 4 materials based on their abilities to conduct heat by placing the letters A, B, C and D in the appropriate boxes. [1]

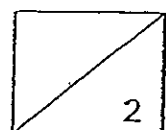
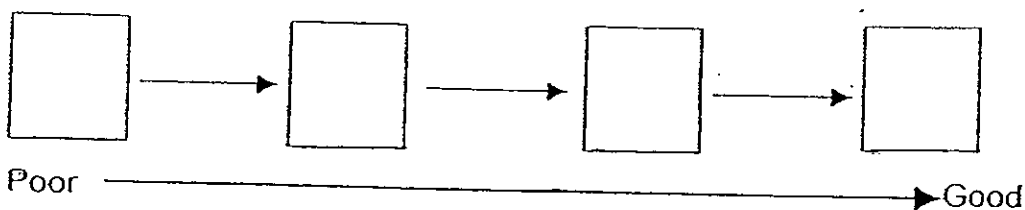

34 Mike wanted to find out how different amounts of water in a glass cup will affect the rate at which ice cubes are melted in the cup. He poured water into three identical beakers and put some ice cubes in each beaker.

(a) Put a tick (✓) in the box(es) for the variables that must be kept constant to ensure that Mike conducts a fair experiment / test.

[1]

Variable	Kept constant
Temperature of water at the beginning	
Amount of water in beaker	
Number of ice cubes	

The results of the experiment are shown below.

Beaker	A	B	C
Temperature of water at the beginning (°C)	30	30	30
Amount of water (ml)	300	200	100
Time taken for ice cubes to melt (s)	60	100	120

(b) In which beaker did the ice cube take the shortest time to melt? [1]

(c) State the relationship between the amount of water and the time taken to melt the ice cubes. [1]

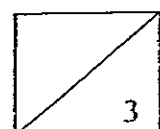

35 The chart below shows some materials classified into 2 groups, A and B, according to a certain characteristic.

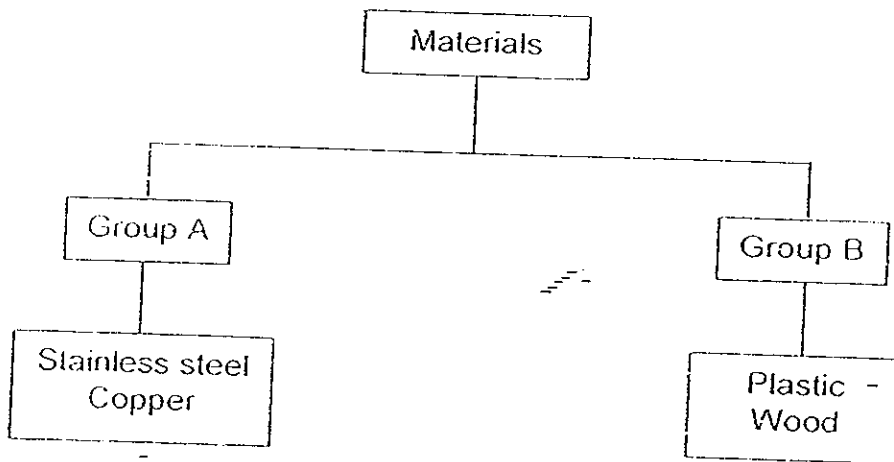

The diagram shows a cooking pot.

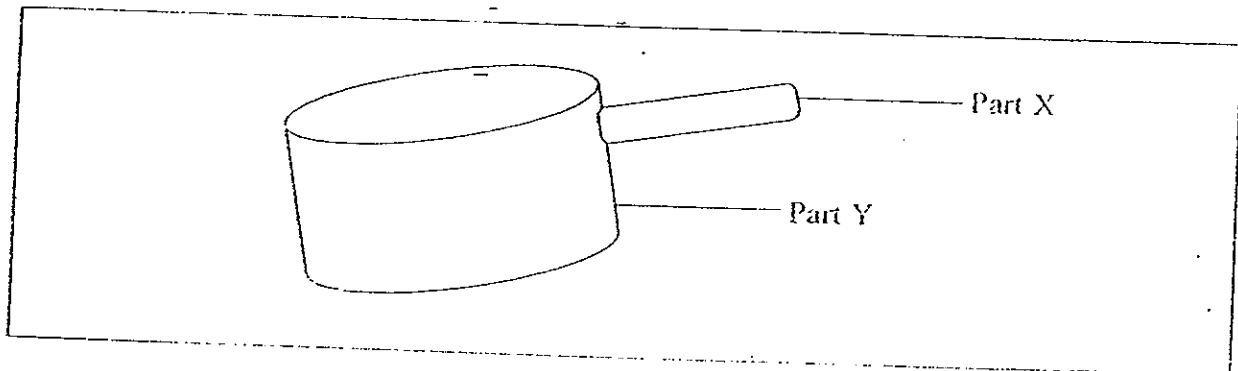

Using the materials in the chart above, suggest a suitable material for Part Y.

(a) Part Y: _____ [1]

(b) An unknown material, Z allows heat to flow through it easily. Which group (A or B) should it be classified under? [1]

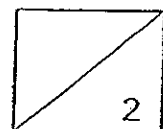

- 36 The diagram shows a glass bottle covered with a wooden cork. It was heated up until the wooden cork popped out.

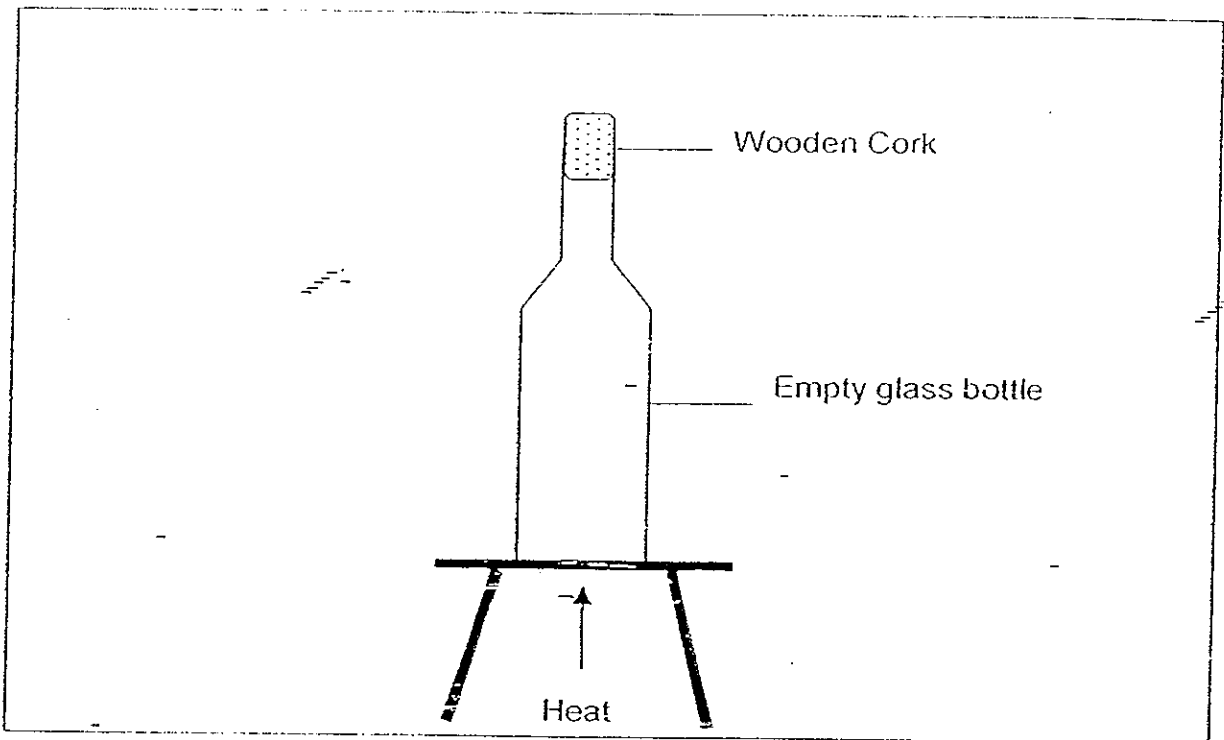

Why did the wooden cork pop out after the glass bottle was heated? [2]

37 Study the flowchart below carefully.

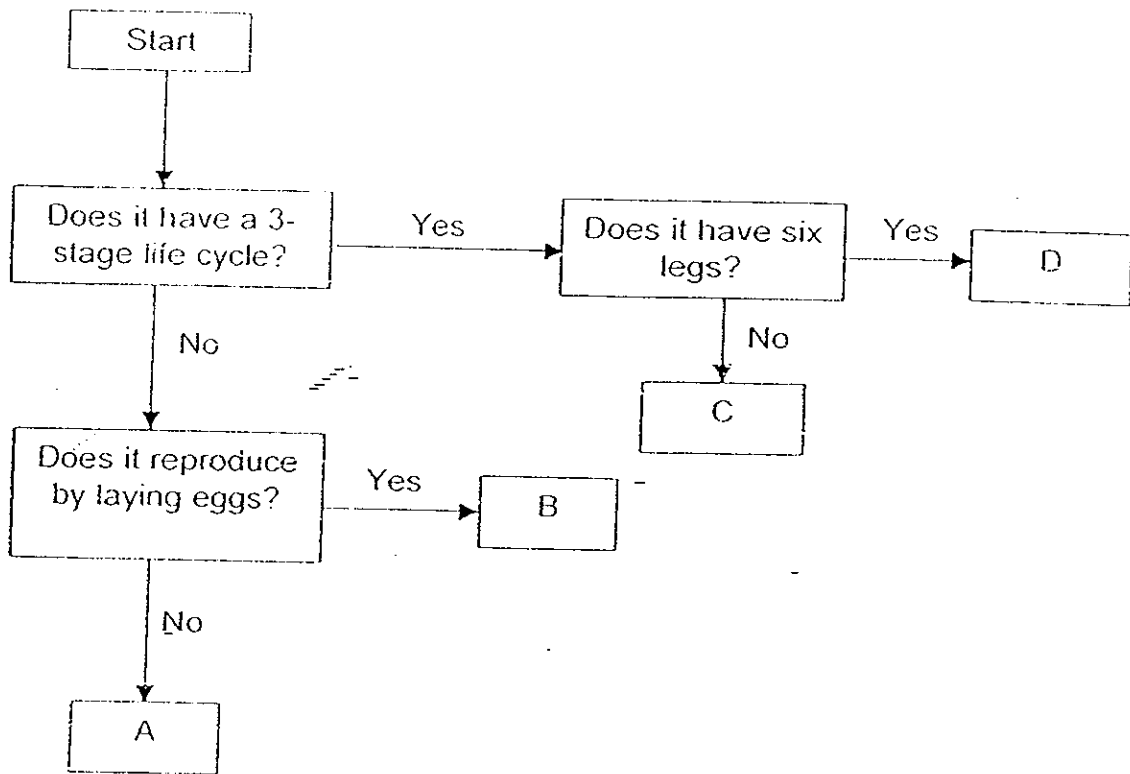

Refer to the flowchart above and sort the following animals accordingly. [2]

Butterfly Tiger Grasshopper Frog

Box	Animal
A	
B	
C	
D	

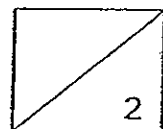

38 The table below shows the characteristics of 5 animals, A, B, C, D and E.

Animal	Has hair / fur?	Live in water?	Has more than 4 limbs / legs?
A	No	No	No
B	No	Yes	Yes
C	Yes	No	No
D	Yes	Yes	No
E	No	No	Yes

(a) Which animal is most likely to be an orangutan? [1]

(b) Can Animal E be a bird? Why? [1]

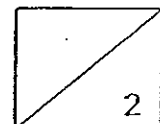

39 James conducted an experiment using set-ups, A, B and C, as shown in the diagrams below. The cups in the set-ups are of the same size and thickness but made of different materials. All of them are filled with cooking oil and have similar balls in them. For each set-up, he wanted to find out if he was able to remove the ball from the cup by sliding the magnet along the outer surface of the cup right to its brim.

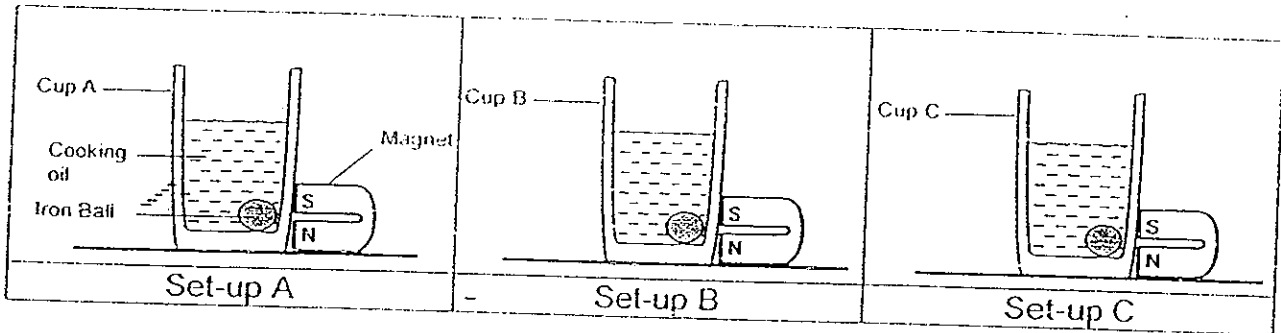

(a) List two variables that must be kept constant for his experiment to be a fair one [2]

(b) In the experiment, James succeeded in removing the iron balls out from Cup B and Cup C only.

Based on this result, indicate with a tick (✓) whether each of the statement is 'True', 'False' or 'Not possible to tell'. [2]

	Statements	True	False	Not possible to tell
(i)	The balls are made of iron.			
(ii)	Magnet in set-up A is the weakest.			
(iii)	Only Cup B and Cup C allowed magnetism to pass through them.			

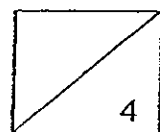

40 Study the flowchart below.

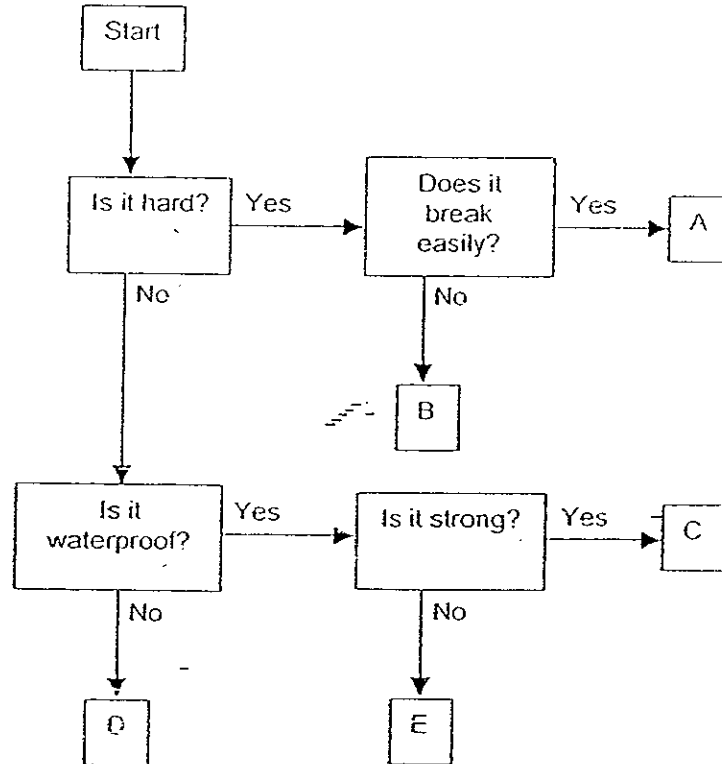

(a) What is/are the characteristic(s) of material C? [2]

(b) What is/are the difference(s) between the properties of material A and material B? [1]

(c) Based on the flowchart, write the letters, A, B, C, D or E, in the boxes to indicate the group in which the body frame and the tyre of the bicycle belong to. [1]

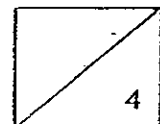
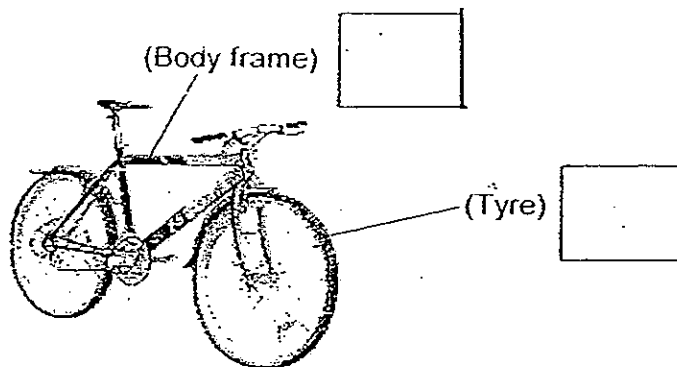

41. Look at the diagram below carefully.

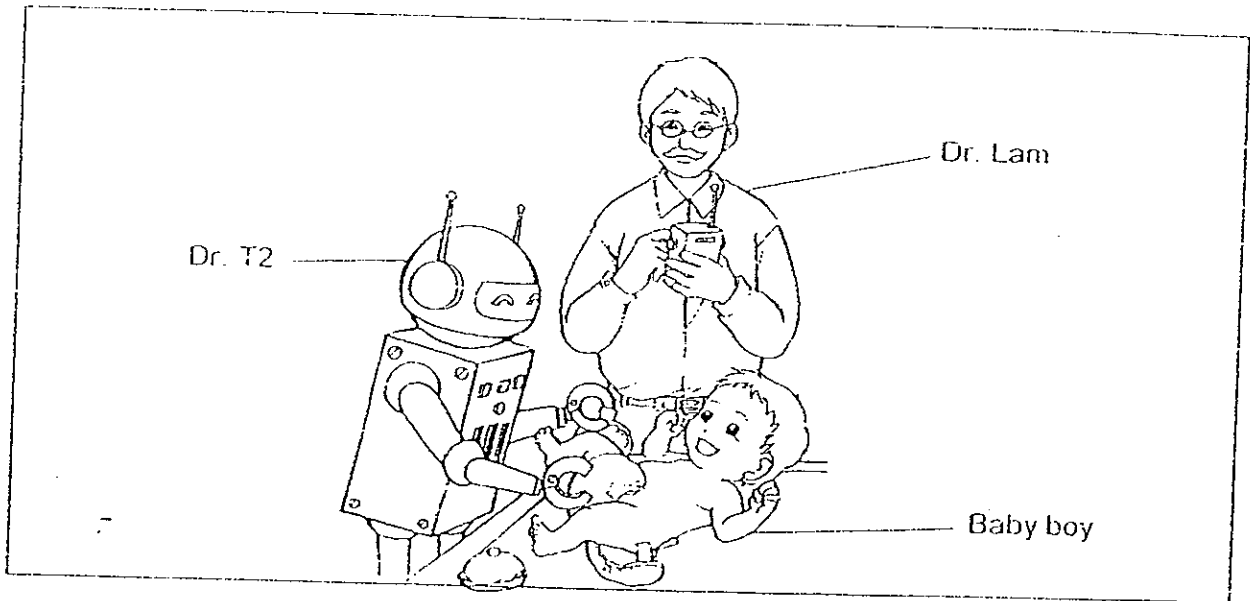

(a) Based on the diagram shown above, write down one similarity between the robot Dr T2 and Dr. Lam. [1]

(b) State one basic thing which living things need to survive but robot Dr T2 does not. [1]

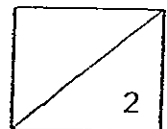

42 Study the classification chart.

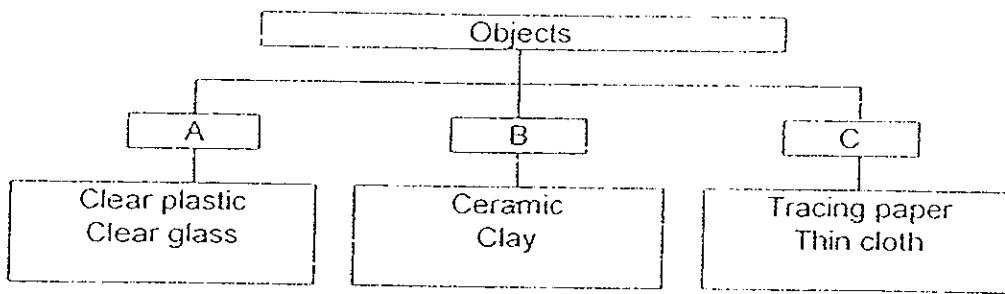

(a) If A represents 'Transparent', what does B represent? [1]

(b) In which group would you place 'Frosted glass'? [1]

43 The diagram below shows a Red Cross Donation tin.

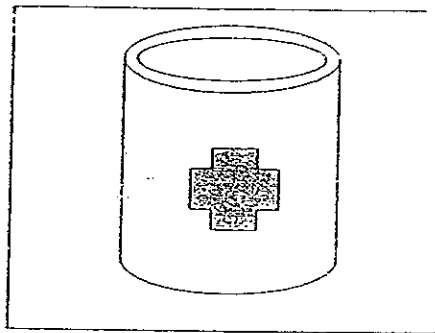

In the 2 boxes below, draw 2 possible shadows that the tin can cast if it is placed between a light source and a screen. [2]

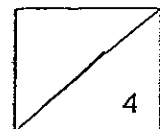
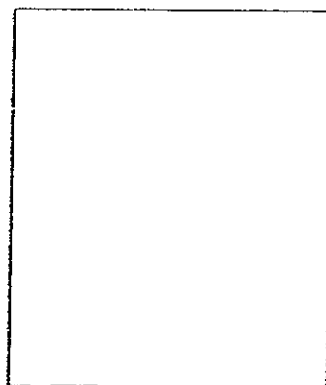
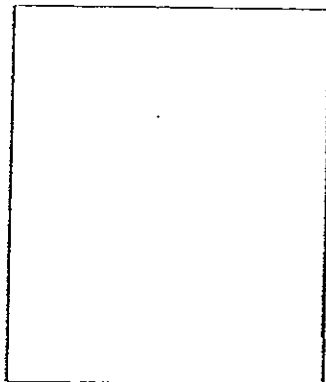

- 44 Vijay placed a drink can in between a torch and a screen as shown in the following set-up.

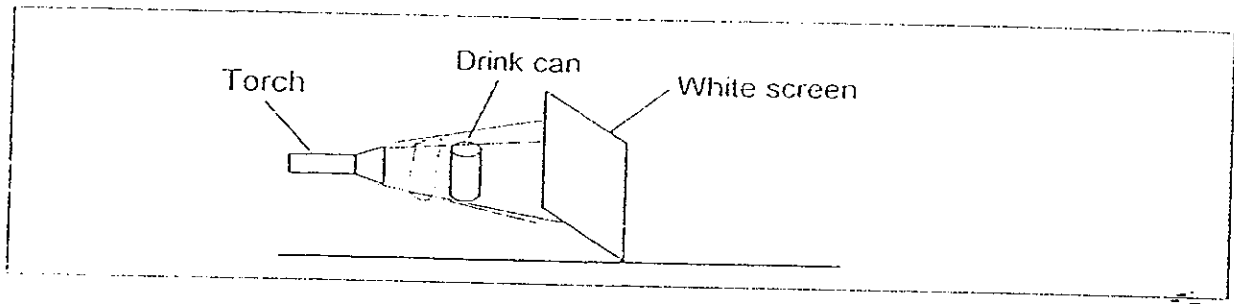

- (a) What could he do to increase the size of the shadow cast on the white screen? [1]

- (b) What could he do to make the shadow cast on the white screen sharper? [1]

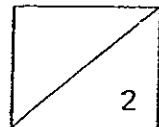

- 45 Mr. Goh was riding a motorcycle towards the West and the sun was shining directly at him.

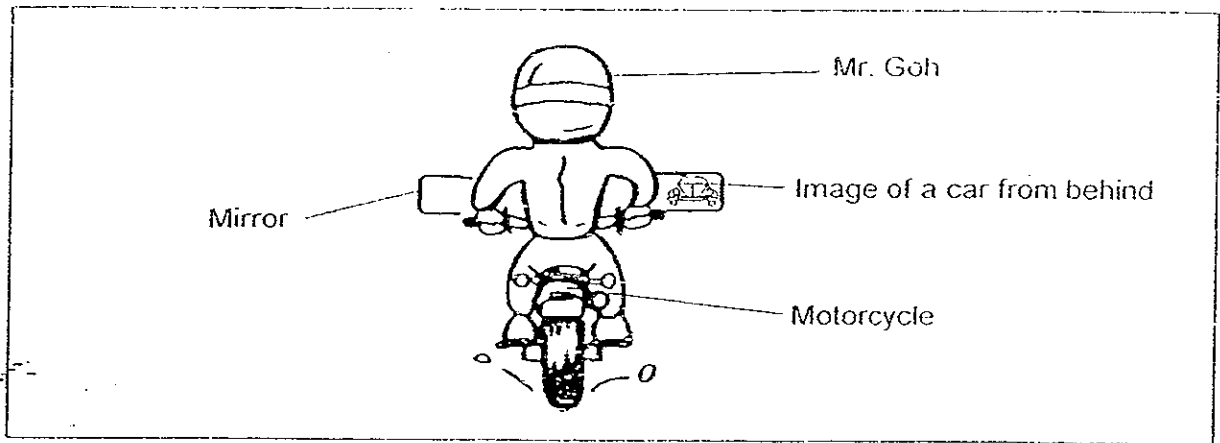

- (a) Based on the diagram shown above, complete the sentence below. [2]

Mr. Goh is able to see the car because the car will _____ light from the _____ onto the mirror. The _____ then reflects the _____ to Mr. Goh's eyes.

- (b) Mr. Goh made a 90° turn on his right. On which side of Mr. Goh (right or left), would the shadow of the motorcycle be formed? [1]

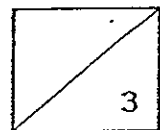

46 Study the diagrams below carefully.

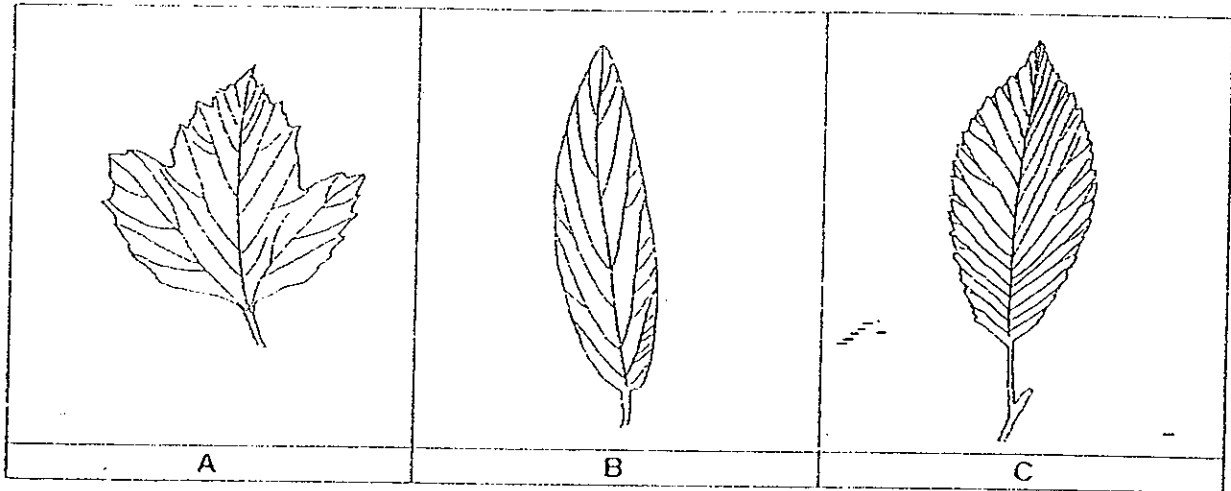

(a) In which group would you place the leaves of the 3 different plants shown above? Write the letters A, B and C in the correct empty boxes provided below. [2]

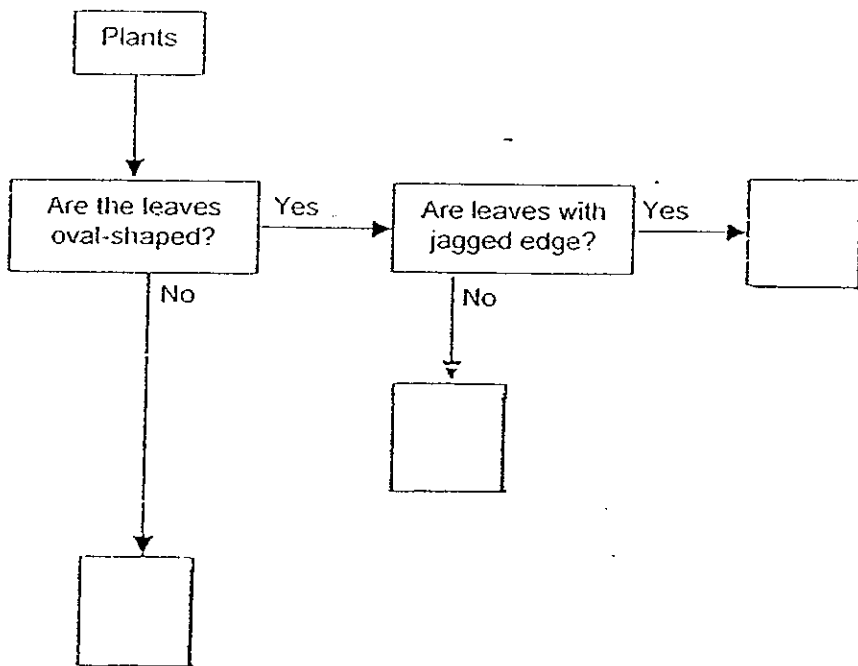

(b) What do leaves need in order to make food during photosynthesis? [1]

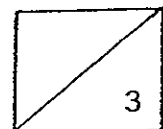

END OF PAPER. PLEASE CHECK YOUR ANSWERS.

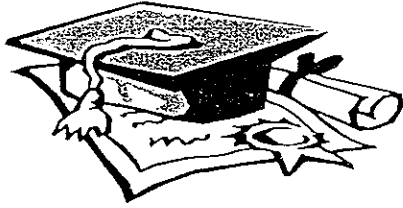

ANSWER SHEET

EXAM PAPER 2008

SCHOOL : A C S PRIMARY SCHOOL

SUBJECT : PRIMARY 4 SCIENCE

TERM : SA 1

Q1	Q2	Q3	Q4	Q5	Q6	Q7	Q8	Q9	Q10	Q11	Q12	Q13	Q14	Q15	Q16	Q17
2	4	3	4	2	3	1	3	2	4	2	1	2	3	3	4	1

Q18	Q19	Q20	Q21	Q22	Q23	Q24	Q25	Q26	Q27	Q28	Q29	Q30
3	1	1	2	2	2	2	2	4	4	3	3	1

31) a) i) fins ii) gill cover

b) The fish have an outer-covering of scales.

32) a) W b) X c) YZ

33) a) D $\xrightarrow{\quad\quad\quad 5}$

b) A \rightarrow C \rightarrow D \rightarrow b

34) a) Temperature of water at the beginning.

Number of ice cubes.

b) C.

c) The more water, the faster it is for the ice cube to melt.

35) a) Stainless steel.

b) Group A.

36) The air in the glass bottle gained heat and expanded that is why the wooden cork pop out after the glass bottle was heated.

37) A=Tiger B=Butterfly C=Frog D=Grasshopper

38) a) C

b) No. Birds have 2 limbs.

39) a) Strength of magnet and the amount of cooking oil.

b) i) True ii) Not iii) True

40) a) It is not hard it is waterproof it is string.

b) Material A breaks easily but material B does not break easily.

c) Body frame=B

Tyre =C

41) a) They have arms.

b) Living things need air but robot Dr. T2 does not need air.

42) a) Opaque b) C

43) ■ ●

44) a) He could move the drink can nearer to the torch.

b) Move the drink can nearer to the torch.

45) a) reflect, sun, mirror, light

b) Right.

46) a) i) C ii) B iii) C

b) Leaves need water, carbon dioxide and light to photosynthesis.