

SINGAPORE CHINESE GIRLS' SCHOOL
FIRST SEMESTRAL ASSESSMENT 2008
PRIMARY 4 SCIENCE

Name: _____ () Date: _____
Class: Primary 4 SY C/G/SE/P Duration: 1hr 15 mins

Part I (40 marks)

For each question from 1 to 20, four options are given. One of them is the correct answer. Make your choice (1, 2, 3 or 4) on the Optical Answer Sheet provided.

1) Which of the following is not a living thing?

- | | |
|-----------|-----------------|
| 1) car | 3) stone fish |
| 2) cactus | 4) cotton plant |

The diagram below shows a kettle. Answer questions 2 and 3 that follow.

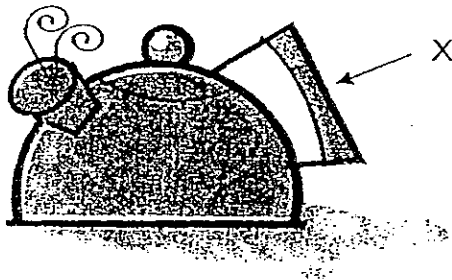

2) The material that is commonly used to make the part labelled X is _____

- 1) cloth
- 2) plastic
- 3) leather
- 4) styrofoam

3) What property of X makes it most suitable for making that part of the kettle? It is _____

- 1) light.
- 2) durable.
- 3) waterproof.
- 4) a bad conductor of heat.

4)

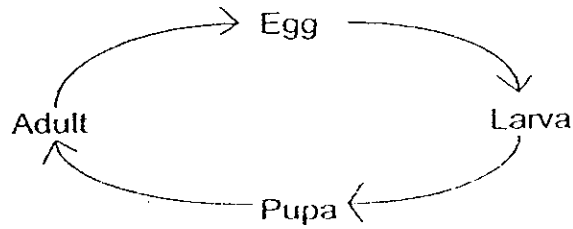

Which of the organisms below undergo the life cycle shown above?

A: Bee

C: Mosquito

B: Butterfly

D: Mealworm beetle

1) B and C only

3) A, B and C only

2) B, C and D only

4) All of the above

5) Which of the following statements about the nymphs of the grasshopper and the cockroach is correct?

false

1) Both are herbivores.

2) Both do not have wings.

3) Both have no backbones.

4) Both have no outer coverings.

6) Jonathan placed a plant into a beaker of water mixed with blue dye. He placed the plant near a window sill for 5 days. Jonathan then cut the stem of the plant horizontally. What should ~~she~~ observe?

he

1)

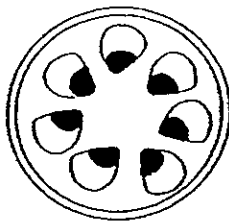

3)

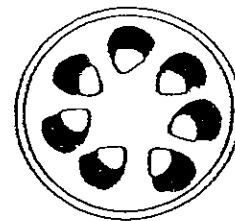

2)

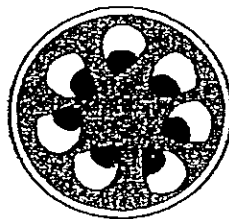

4)

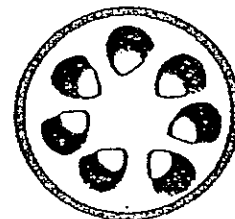

Legend:

■ Light blue ■ Dark blue

7) Which part of the digestive system does not contain digestive juices?

- 1) Mouth
- 2) Stomach
- 3) Small intestine
- 4) Large intestine

8) Which of the following will take place if our digestive system does not have the large intestine?

- 1) Digestion ~~will be~~ incomplete.
- 2) Nutrients will not be absorbed.
- 3) Stool will be very dry and hard.
- 4) Soft and watery stool will be passed out.

9) Which of the following are required by plants for the process of photosynthesis to take place?

- A: oxygen
- B: sunlight
- C: carbon dioxide
- D: chlorophyll
- E: water

- 1) A, B, C and E only
- 2) A, B, D and E only
- 3) B, C, D and E only
- 4) All of the above

10) Two similar young plants were kept in different environments as shown below. Both had equal supplies of air and water. After ten days, it was discovered that Plant A was greener than Plant B.

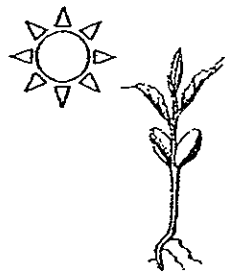

Plant A



Plant B

Plant A turned greener because _____

- 1) it had more air than Plant B
- 2) it had more water than Plant B
- 3) it had more sunlight than Plant B
- 4) it had more chlorophyll than Plant B

11) The air we breathe in is filtered at the _____.

- A: nose
- B: windpipe
- C: lungs

- 1) A only
- 2) C only
- 3) A and C only
- 4) All of the above

12) Which of the following is classified correctly?

| | Magnetic Items | Non-magnetic Items |
|----|-----------------|--------------------|
| 1) | Aluminium foil | Steel sheet |
| 2) | Nickel coin | Copper wire |
| 3) | Silver wire | Gold ring |
| 4) | Iron thumb tack | Nickel coin |

13)

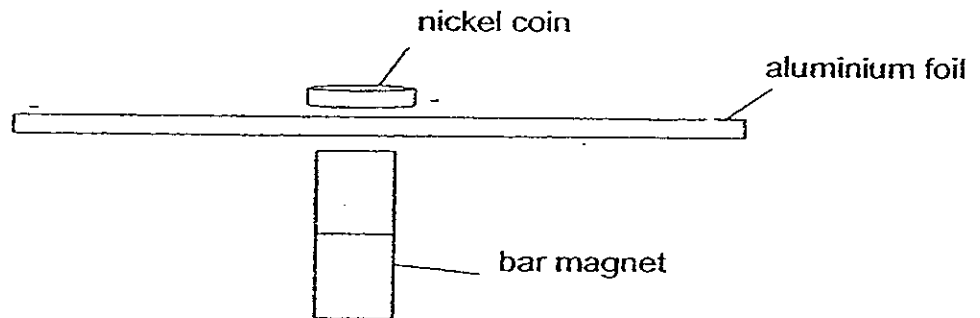

Which of the following best describes and explains what happens when a bar magnet approaches a nickel coin through a sheet of aluminium foil?

- 1) Nothing will happen because nickel is a non-magnetic metal.
- 2) Nothing will happen because magnets cannot work through metallic materials.
- 3) The bar magnet will attract the nickel coin because magnets can work through non-magnetic metals.
- 4) The bar magnet will not attract the nickel coin because magnets cannot work through non-magnetic metals.

14) Which of the following correctly shows the passage of light when a torch is shone against a sheet of mirror?

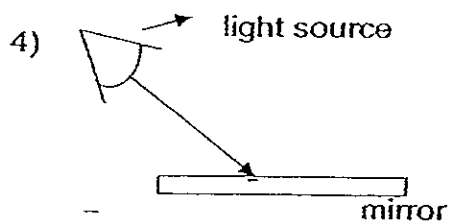
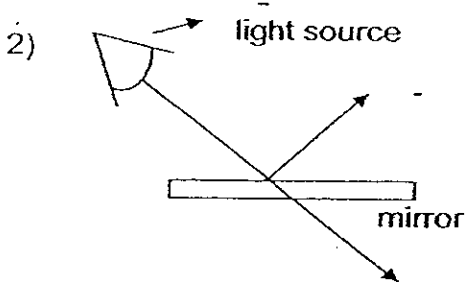
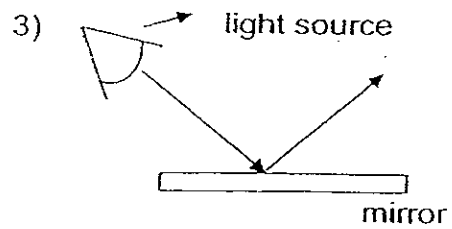
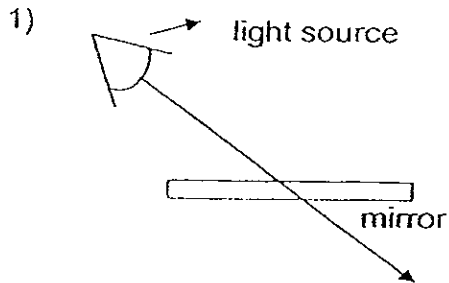

15) The diagram below shows the path of light from A to B to C. Which of the following options correctly shows what A and B are?

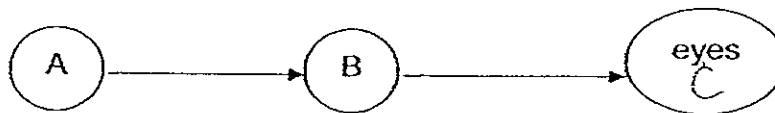

| | A | B |
|---------------|--------------------|--------------------|
| 1) | Transparent object | Opaque Object |
| 2) | Light source | Transparent object |
| 3) | Light source | Opaque Object |
| 4) | Opaque Object | Opaque Object |

- 16) Light casts a shadow when it falls on an opaque object. However, the object shown below did not cast any shadow on the screen. Which of the following statements is/are likely reason/s for this?

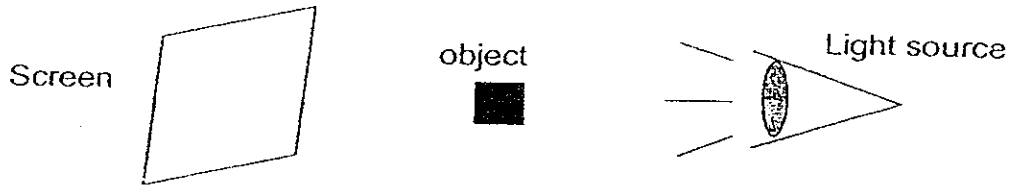

- A: The object is transparent.
 B: The object is translucent.
 C: The screen is transparent.
 D: The screen is translucent.

- 1) A only
 2) C only
 3) A and C only
 4) B and D only

- 17) Which one of the following statements about heat is correct?

- 1) Heat is a hot substance.
 2) Heat is a form of energy.
 3) Heat is the same as temperature.
 4) Heat flows from a colder place to a hotter place.

- 18) Chloe set up an experiment as shown below.

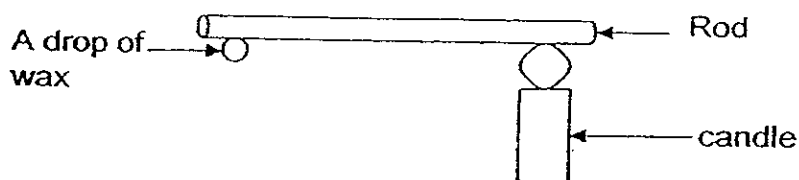

She repeated the experiment using 4 different rods and recorded the time taken for the wax to melt. Her results are tabulated below.

| Type of Rod | Time taken for wax to melt (mins) |
|-------------|-----------------------------------|
| Steel | 2 |
| Plastic | 5 |
| Wood | 4 |
| Iron | 3 |

What can she conclude from the experiment?

- A: Steel is the worst conductor of heat.
 B: Plastic is a better insulator than Wood.
 C: Steel is a better conductor of heat than Iron.
 D: Iron is a better conductor of heat than Steel.

- 1) A only
 2) C only
 3) B and C only
 4) A and C only

- 19) Tom set up the experiment below to find out which material is able to lose heat faster.

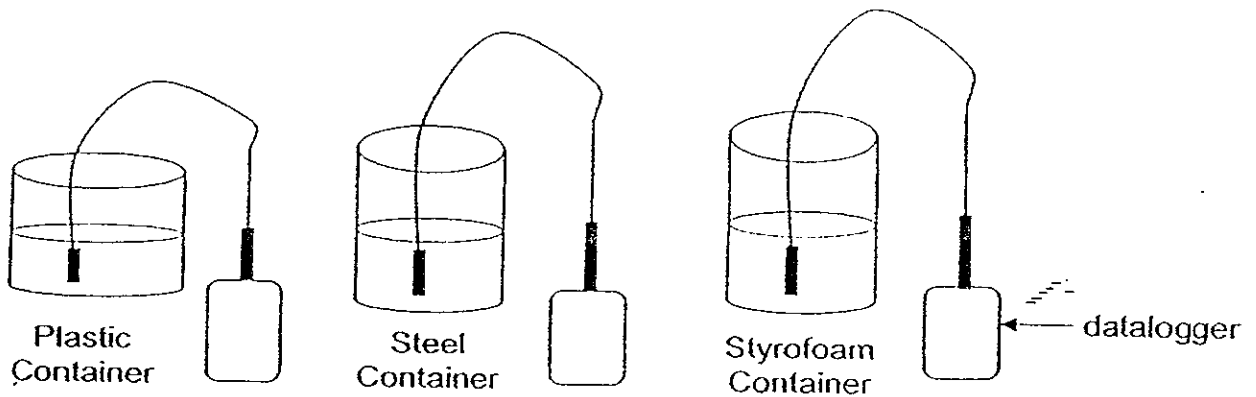

Each container contains 150ml of water at 80°C. Tom measured the temperature of the water in each container 10 minutes later and concluded that plastic is the fastest at losing heat. You can argue that he is wrong because _____.

- 1) reading from the datalogger is wrong.
 - 2) the size of the container was not the same.
 - 3) temperature is not the best way to indicate heat lost.
 - 4) the amount of water in each container was not the same.
- 20) In the following experiment, an empty bottle with a balloon stretched over its opening and secured with masking tape is placed inside a trough of hot water. Which of the following correctly predicts what will happen?

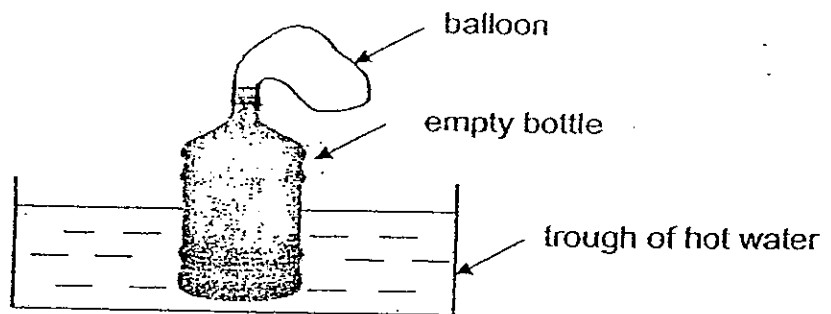

- 1) The balloon inflated slightly.
- 2) The balloon remained the same.
- 3) The balloon was sucked into the bottle.
- 4) The balloon was forcefully pushed off the bottle opening.

SINGAPORE CHINESE GIRLS' SCHOOL
FIRST SEMESTRAL ASSESSMENT 2008
PRIMARY 4 SCIENCE

Name: _____ ()
Class: Primary 4 S/Y/C/G/SE/P

Date: _____
Duration: 1hr 15 mins

| | |
|-------------------------|-----------|
| Written Paper (Part I) | 40 |
| Written Paper (Part II) | 20 |
| Total | 60 |

Parent's Signature

Part II (20 marks)

Read and answer questions 21 to 28.

21) The following diagram shows a life cycle of a mosquito.

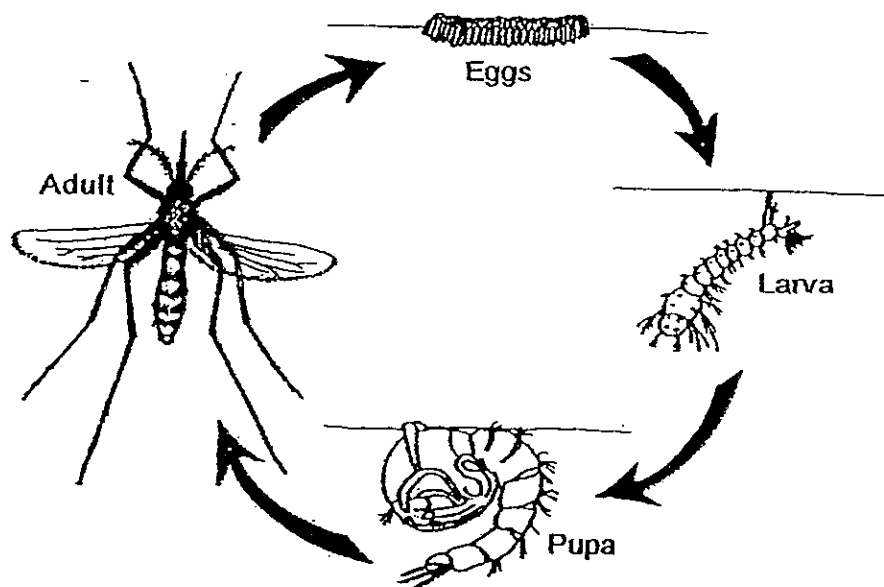

a) At which stage of the life cycle is the mosquito considered a pest?
(1 mark)

b) Adeline: The best way to get rid of mosquitoes is to use insecticide.
Betty: No, the best way is to get rid of all water lying around in the house.

Who has the more effective method? Give a reason for your answer.
(2 marks)

22) Andrew set up a model of the respiratory system as shown below.

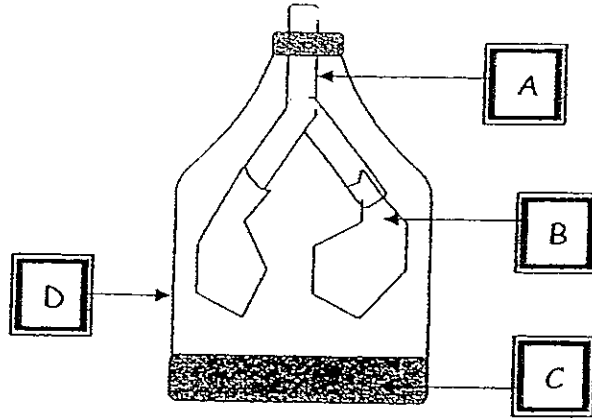

What do A, B, C and D represent? (2 marks)

A: _____ B: _____
 C: _____ D: _____

23) The diagram below shows part of a plant.

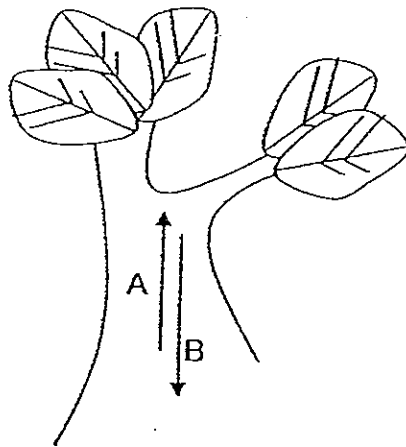

a) Which arrow represents the direction of water and minerals transported by the plant? (1 mark)

b) Which arrow represents the direction of food transported by the plant? (1 mark)

- 24) The diagram below shows the path that the food takes in human. Label the different parts of the diagram. (3 marks)

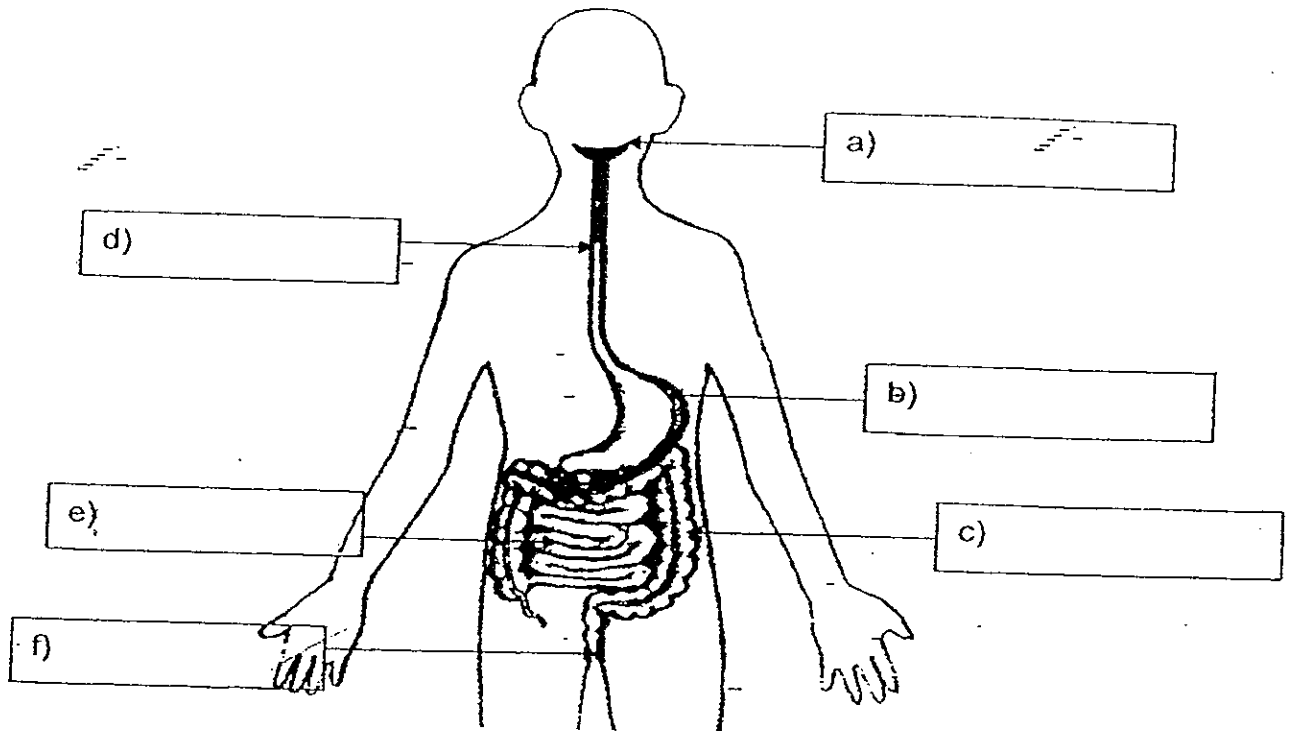

- 25) Study the classification chart and fill in the blanks with suitable headings. (2 marks)

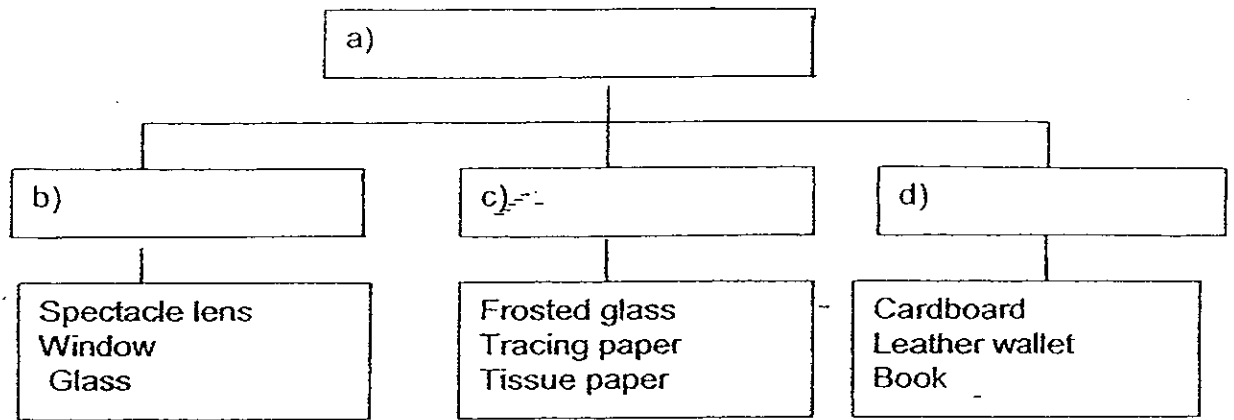

- e) a) Study the diagrams below. Put a tick in the box that represents a piece of glass. (1 mark)

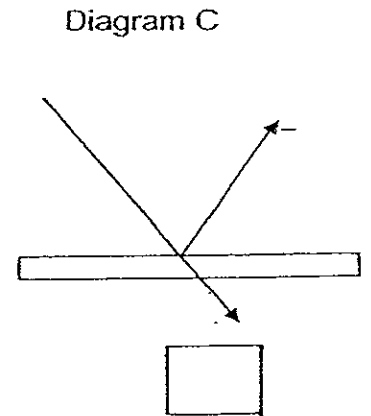
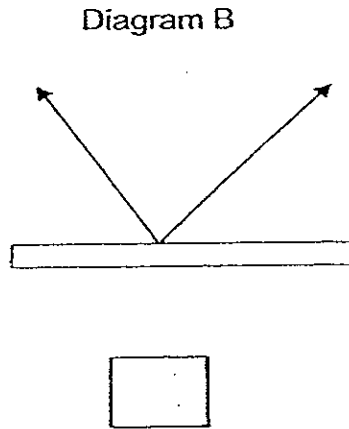
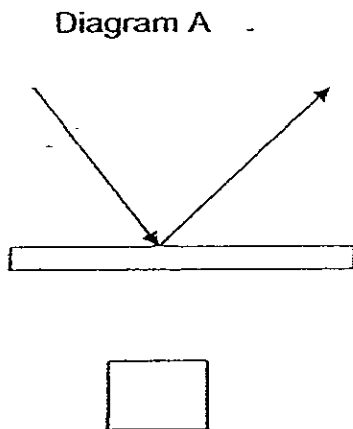

- 26) Coleen conducted an experiment by measuring the length of her shadow on the ground at different time intervals over one day. She remained at the same spot for the whole duration. The following graph shows her findings.

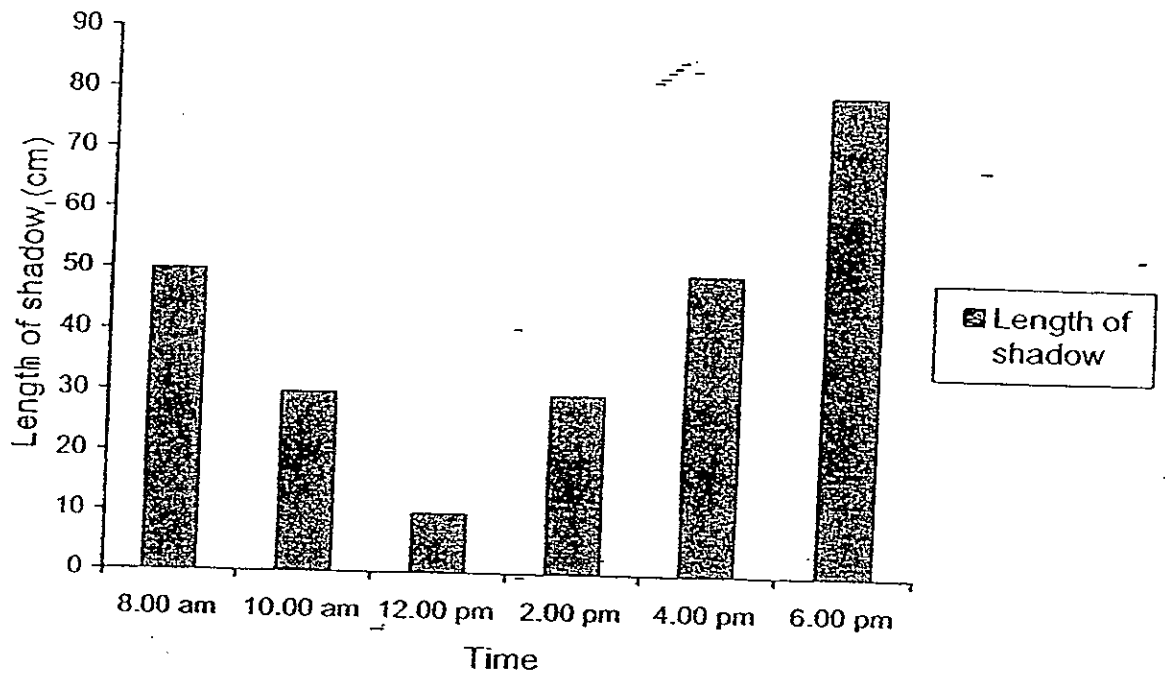

- a) What is the relationship between the length of the shadow and the time of the day? (1 mark)

- b) Explain your answer in (a). (1 mark)

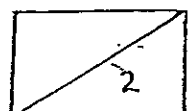

- 27) Kendra tries to open the bottle of mushrooms as shown below, but finds that the cover is stuck to the bottle.

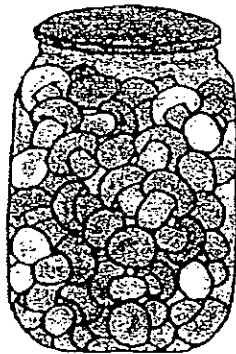

- a) What is one method involving heat that can be used to separate them?
(1 mark)

- b) Explain why this method will work. (1 mark)

- 28) Georgia's mother cools a bottle of hot milk by putting it into a basin of cold water.

- a) Describe the temperature change in the milk. (1 mark)

- b) Describe the temperature change in the cold water (1mark)

- c) Georgia's mother forgot about the milk till 6 hours later. What is most likely to happen to the temperature of the milk and water after this time?
(1 mark)



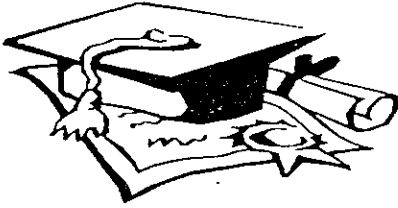

ANSWER SHEET

EXAM PAPER 2008

SCHOOL : SCGS PRIMARY SCHOOL

SUBJECT : PRIMARY 4 SCIENCE

TERM : SA 1

| | | | | | | | | | | | | | | | | |
|----|----|----|----|----|----|----|----|----|-----|-----|-----|-----|-----|-----|-----|-----|
| Q1 | Q2 | Q3 | Q4 | Q5 | Q6 | Q7 | Q8 | Q9 | Q10 | Q11 | Q12 | Q13 | Q14 | Q15 | Q16 | Q17 |
| 1 | 2 | 4 | 4 | 1 | 1 | 4 | 4 | 3 | 3 | 1 | 2 | 3 | 3 | 2 | 3 | 2 |

| | | |
|-----|-----|-----|
| Q18 | Q19 | Q20 |
| 3 | 2 | 1 |

21) a) It is the adult stage.

b) Betty has the more effective method. Getting rid of all water lying around in the house prevents the breeding of mosquitoes.

22) A: windpipe B: lungs C: diaphragm D: Chest

23) a) Arrow A.

b) Arrow B.

24) a) mouth

b) stomach

c) large intestine

d) gullet

e) small intestine

f) anus

25) a) Degree of transparency

b) Transparent

c) Translucent

d) Opaque

e) C

26)a)The length of the shadow gets shorter the time is nearer to 12.00pm and increases again after 12.0pm

b)The sun moves from the east to the west. At 12.00pm the sun is directly overhead but at 8.00am and 6.00pm ,it is low in the sky.

27)a)Kendra can put hot water on the cover.

b)The cover expands and Kendra can open the bottle of mushrooms.

28)a)The temperature of he milk decreases.

b)The temperature of the water increases.

c)The temperature of the milk and water are the same.