

12

Name: _____ ()

Class: Primary 4 _____

CHIJ ST NICHOLAS GIRLS' SCHOOL



Primary 4
Semestral Assessment 1 – 2016
SCIENCE
BOOKLET A
12 May 2016

Total Time for Booklets A and B: 1 hour 45 minutes

28 questions
56 marks

Do not open this booklet until you are told to do so.
Follow all instructions carefully.
Answer all questions.

This booklet consists of 17 printed pages.

Section A (28 x 2 marks = 56 marks)

For each question from 1 to 28, four options are given. One of them is the correct answer. Make your choice (1, 2, 3 or 4). Shade the correct oval (1, 2, 3 or 4) on the Optical Answer Sheet provided.

1. Some animals are classified according to their life cycles as shown in the chart below.

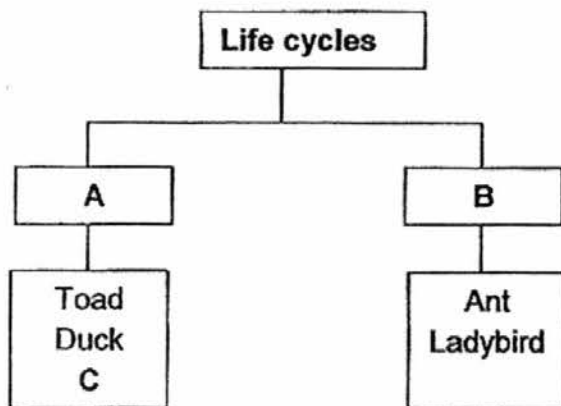

Which of the following correctly represents B and C?

	B	C
(1)	3-stage life cycle	Moth
(2)	4-stage life cycle	Grasshopper
(3)	3-stage life cycle	Cockroach
(4)	4-stage life cycle	Mosquito

2. The characteristics of 3 types of living things, A, B and C, are shown in the table below.

Characteristics	Living Things		
	A	B	C
Does it make its own food?	Yes	No	Yes
Does it have flowers?	No	No	Yes

Which one of the following conclusions is correct?

- (1) A reproduces by seeds
- (2) B and C are mushrooms
- (3) A and C are green plants
- (4) A and B are flowering plants

3. The diagram below shows different parts of the plant.

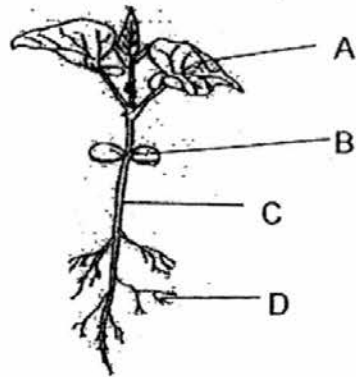

Which part(s) A, B, C or D, make (s) food for the plant?

- (1) A only
- (2) D only
- (3) A and B only
- (4) A, B, C and D

4. Which of the following animals does not have young that resembles the adult?

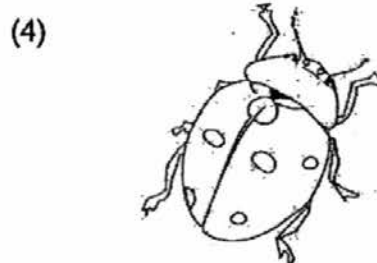
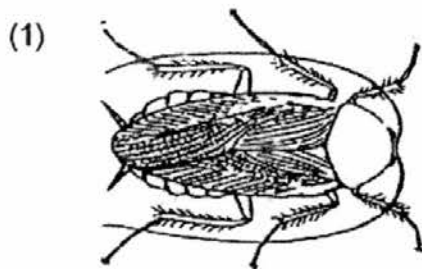

5. Sally conducted an experiment to determine if warmth was necessary for seed germination. She used the same type of seeds.

Set-up	Number of seeds	Place	Amount of water given (ml)
A	5	Open field	200
B	5	Refrigerator	200
C	5	Near an open window	400
D	6	In a dark cupboard	400

Which two setups should Sally use for her experiment?

- (1) A and B
 (2) A and D
 (3) B and C
 (4) C and D
6. Study the flowchart below.

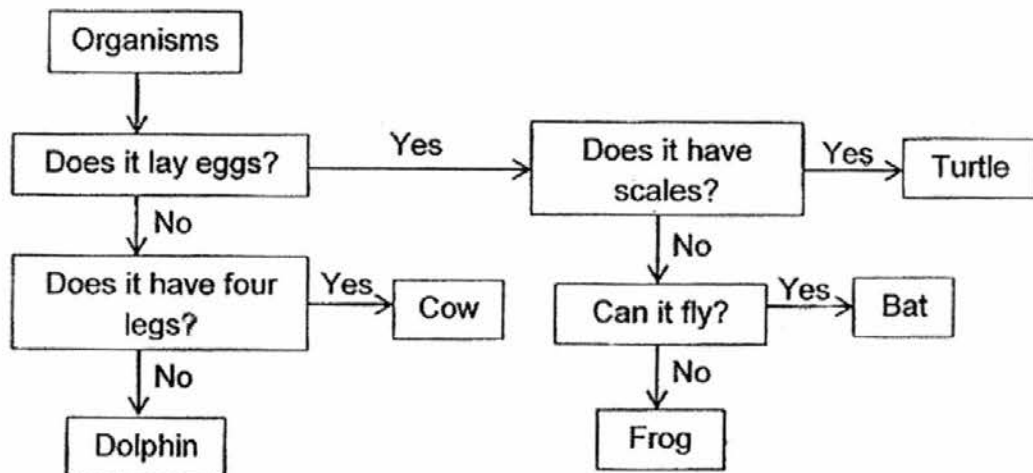

Which animal has been placed wrongly?

- (1) Bat
 (2) Frog
 (3) Turtle
 (4) Dolphin

7. Study the pictures below.



Fern

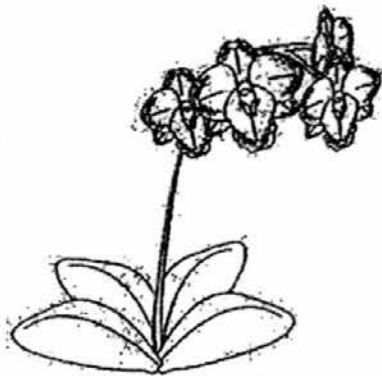

Orchid plant

What observations can be made about the fern and the orchid plant?

- (1) Both the fern and orchid plant reproduce by spores.
- (2) The fern has a weak stem but the orchid plant has a strong stem.
- (3) The fern is a non-flowering plant but the orchid plant is a flowering plant.
- (4) The fern does not need light to grow but the orchid plant needs light to grow.

8. The diagram below shows a fish.

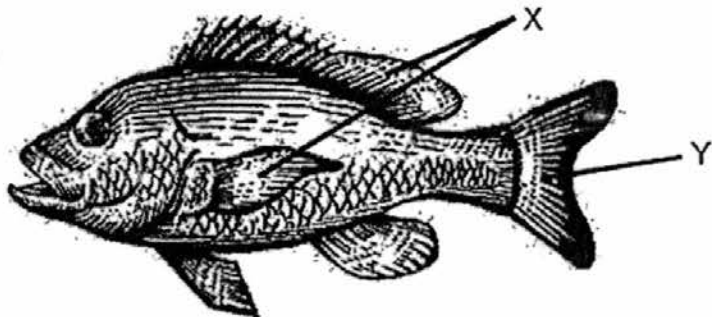

Which one of the following is not a function of parts, X and Y, of the fish?

- (1) To help the fish move forward.
- (2) To help to protect the fish's body.
- (3) To help the fish to balance itself in water.
- (4) To help the fish to change its direction of movement.

9. The table below shows the characteristics of 5 plants, A, B, C, D and E.

Plants \ Characteristics	A	B	C	D	E
Texture of leaves	Smooth	Hairy	Waxy	Smooth	Smooth
Type of stem	Strong	Strong	Weak	Weak	Weak
Shape of leaves	Heart	Oval	Heart	Oval	Heart
Number of seeds	Many	Single	Many	Many	Single

The plants can be classified as shown below.

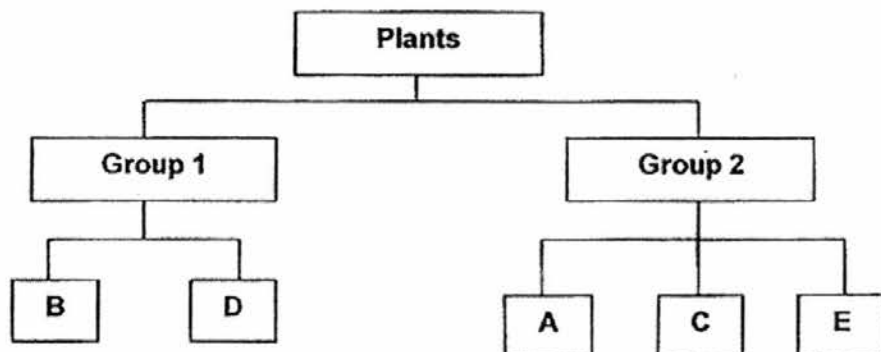

Which one of the following characteristics was used to classify the plants?

- (1) Type of stem
- (2) Shape of leaves
- (3) Texture of leaves
- (4) Number of seeds

10. Timothy made some observations of a teddy bear, a robot dog, a hamster and a cactus. He described their characteristics in the table below.

Characteristics	A	B	C	D
Does it grow?	Yes	No	Yes	No
Can it move from one place to another?	No	No	Yes	Yes
Does it respond to changes?	Yes	No	Yes	Yes

Based on the table above, which one of the following best represents, A, B, C and D?

	Teddy bear	Hamster	Robot dog	Cactus
(1)	C	A	B	D
(2)	A	D	C	B
(3)	D	B	A	C
(4)	B	C	D	A

11. The classification chart below shows how some animals can be grouped.

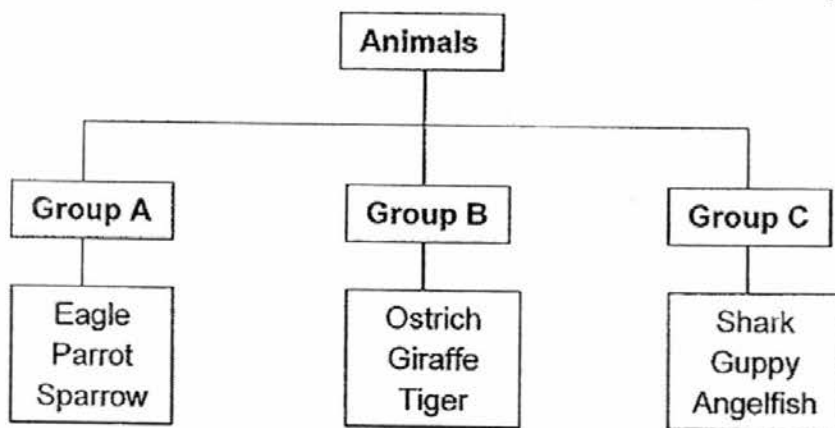

How are the above animals classified?

- (1) By their movement
- (2) By their outer covering
- (3) By their method of breathing
- (4) By their method of reproduction

12. Object X is placed in front of a torch to cast a shadow on the screen as shown in the figure below.

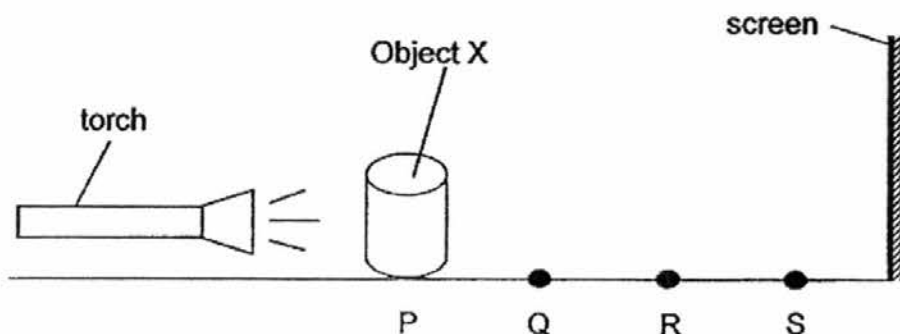

When Object X is at P, the height of shadow cast on the screen is 20cm. Which one of the following correctly shows the height of the shadow cast on the screen when Object X is placed at Q, R and S?

	Height of shadow (cm)		
	Q	R	S
(1)	16	18	20
(2)	22	20	18
(3)	18	16	14
(4)	22	24	26

13. Reuben placed two glass containers with a capacity of 500cm^3 each on a balance as shown in the diagram below. Each container contained 200cm^3 of water.

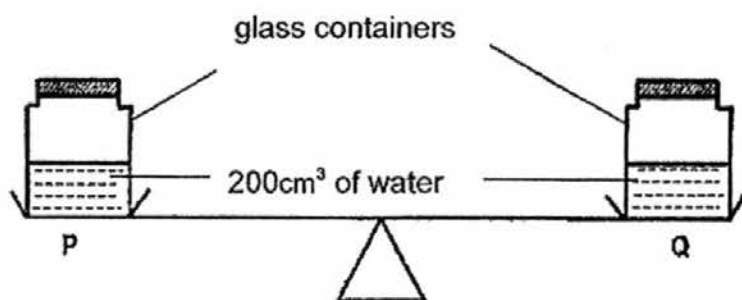

Reuben pumped in an additional 50cm^3 of air into Container P. Which of the following statement(s) is/ are correct?

- A The side with container P moved downwards.
 B The air in container P occupied a volume of 300cm^3 .
 C The volume of water in container P decreased to 150cm^3 .
- (1) B only
 (2) A and B only
 (3) A and C only
 (4) B and C only

14. Roberta set up an experiment to find out if the thickness of a rope would affect the number of weights it can hold.

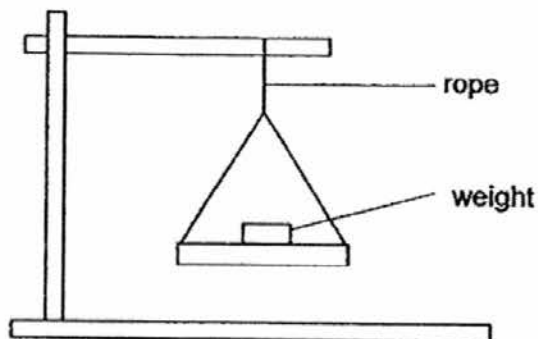

She used 4 ropes, P, Q, R and S. She added weight, of the same mass, until the rope broke. The table below shows the number of weight that each rope could hold before it broke.

Rope	Thickness of rope (units)	Number of weights
P	1	5
Q	2	10
R	3	15
S	4	20

Based on the table above, what conclusion can Roberta draw about the strength of the rope?

- (1) The greater the number of weights, the heavier the rope.
 - (2) The longer the rope, the greater the strength of the rope.
 - (3) The thicker the rope, the greater the strength of the rope.
 - (4) The greater the number of weights, the lesser the strength of the rope.
15. Which of the following is not a source of light?
- A Moon
 - B Cloud
 - C Firefly
 - D Lightning
 - E Torchlight
- (1) A and B only
 - (2) C and D only
 - (3) A, B and C only
 - (4) C, D and E only

16. Jered was given a bar magnet and a rod magnet. He placed the bar magnet at one end of the ruler and slowly pushed a paper clip towards it until the paper clip was attracted to the magnet. He repeated the experiment with the rod magnet.

Before



After

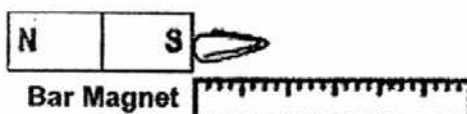

Before

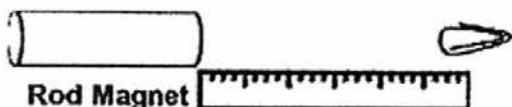

After

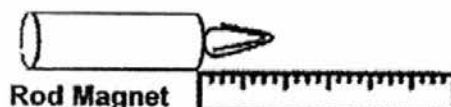

What must Jered measure to find out which magnet has a greater magnetic strength?

- (1) He should measure the distance between the ruler and the paper clip.
 - (2) He should measure how fast the paper clip is attracted to the magnet.
 - (3) He should measure the distance between the magnet and the paper clip.
 - (4) He should measure the distance from where the paper clip is attracted to the magnet.
17. When Jessie was standing behind the wall as shown below, she could not see the chair.

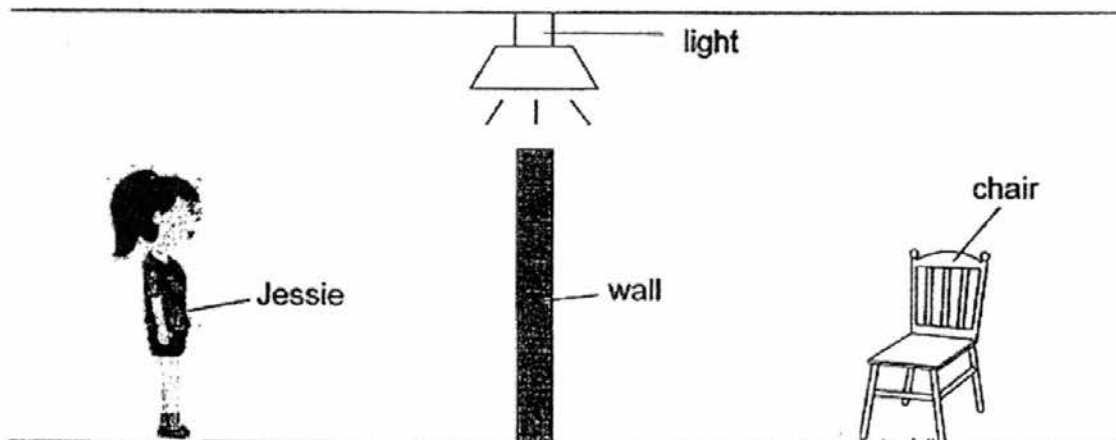

Which one of the following was the reason why Jessie could not see the chair?

- (1) The wall did not reflect light.
- (2) The chair did not reflect light.
- (3) The chair did not give off light.
- (4) The wall did not allow light to pass through.

18. The following diagram shows the water level in a measuring cylinder when three different objects, A, B and C, are placed into the cylinder one after the other.

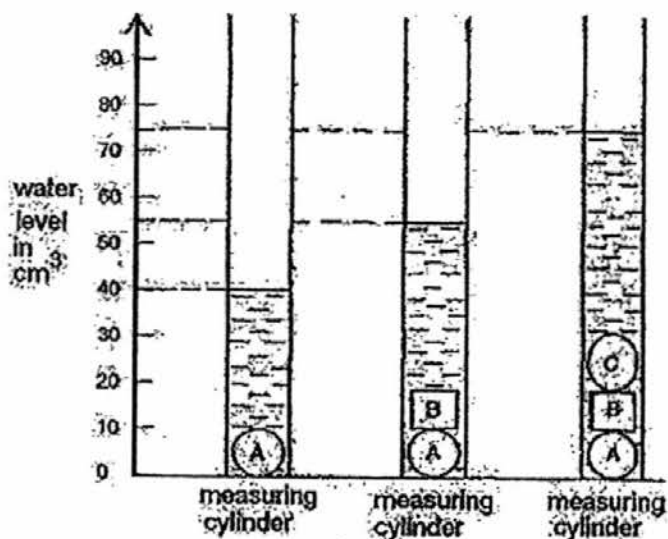

Which one of the following statement is true?

- (1) The total volume of objects A and C is 40cm^3 .
 - (2) The total volume of objects B and C is 35cm^3 .
 - (3) Objects B and C occupy the same amount of space.
 - (4) Object C occupies the most space and object B occupies the least space.
19. A bar magnet was broken into two parts, X and Y, as shown below.



Which of the following arrangement cannot be formed from X and Y?

- (1)
- (2)
- (3)
- (4)

20. The table below records the properties of X, Y and Z. A tick (✓) indicates the presence of the property while a cross (×) indicates the absence of the property.

Properties	X	Y	Z
It has mass.	✓	✓	×
It occupies space.	✓	✓	×
It has definite shape.	×	×	×
It has definite volume.	✓	×	×
It is visible.	✓	×	✓

Which one of the following best represents X, Y and Z?

	X	Y	Z
(1)	rain	wind	light
(2)	air	oxygen	electricity
(3)	baby powder	carbon dioxide	dust
(4)	orange juice	shadow	lightning

21. The diagram below shows an object.



Which one of the following shadows can be formed by the object above?



A



B



C



D

- (1) A and B only
 (2) C and D only
 (3) A, B, C and D
 (4) A, B and D only

22. There were two containers on a table, an empty beaker and a flask with water. Water from the flask was poured into the beaker.

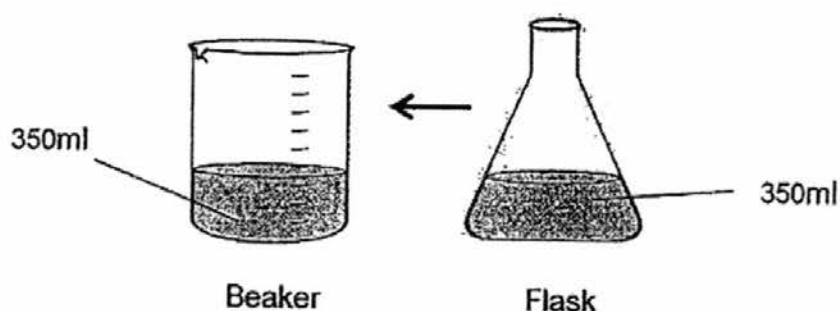

What can be concluded about water from the above activity?

- (1) The water has the same mass and a definite shape.
- (2) The water has the same mass and a definite volume.
- (3) The water has the same mass but indefinite volume.
- (4) The water has a definite volume but different mass.

23. Study the flow chart below.

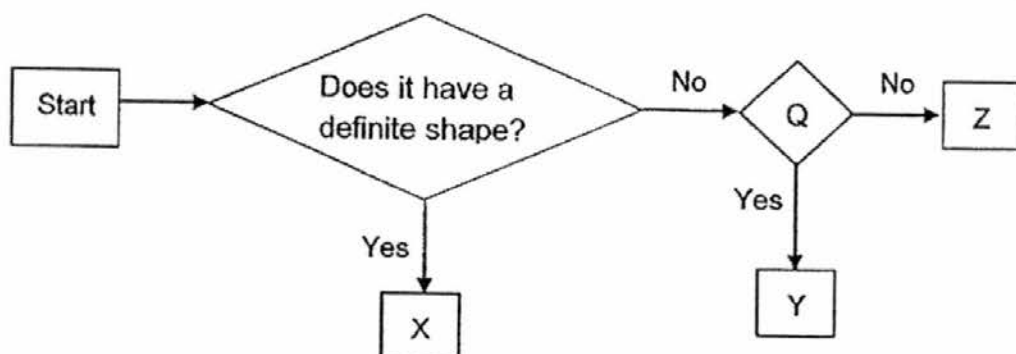

If Y is carbon dioxide and Z is apple juice, which of the following questions should be placed at Q?

- (1) Does it have mass?
- (2) Can it be compressed?
- (3) Does it take up space?
- (4) Does it have a fixed volume?

24. Sara set up the experiment as shown below to measure the amount of water different materials, P, Q and R, can absorb over 5 minutes.

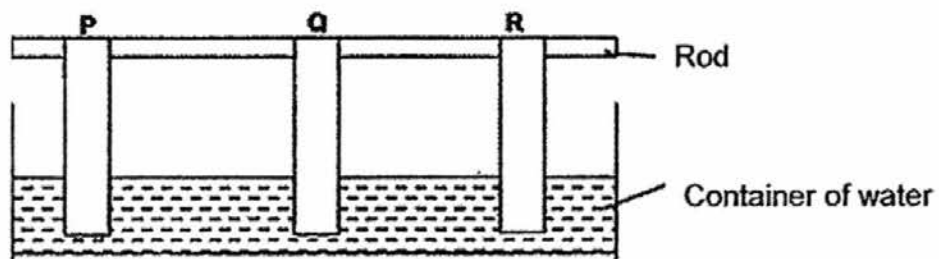

At the end of her experiment, she concluded that Q absorbed the most amount of water while R absorbed the least amount of water.

Which of the following best shows her experimental result for her to make the above conclusion?

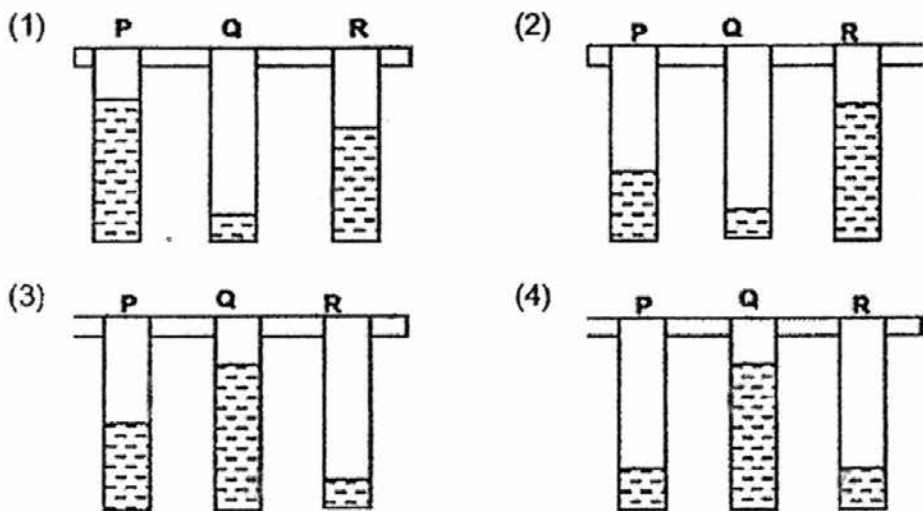

25. Li Na made an electromagnet as shown below. The batteries were connected to the wires correctly and both the batteries were working well.

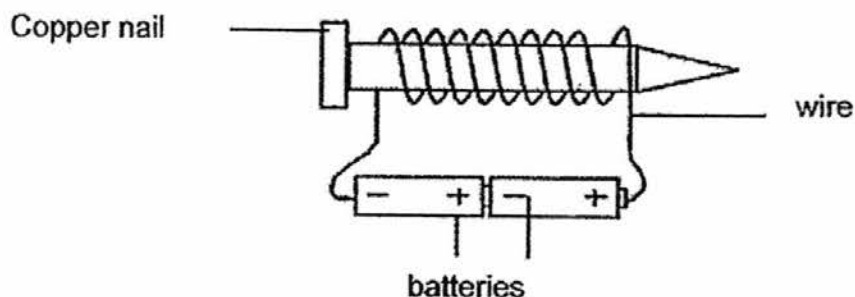

Li Na found that the electromagnet did not attract any paper clips that were brought close to it. Why were the paper clips not attracted to the electromagnet?

- (1) The wire was too short.
 - (2) There were not enough batteries.
 - (3) There were too few coils around the copper nail.
 - (4) The copper nail is a non-magnetic material so it cannot be magnetised.
26. When two objects, A and B, are brought near to each other, they moved in the direction as shown by the arrows.

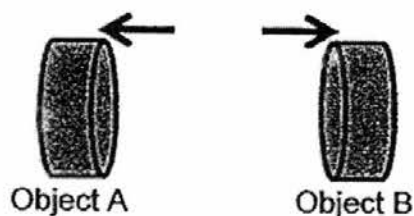

What can we conclude about the 2 objects from the above observation?

- (1) The two objects are magnets.
- (2) The two objects are made of steel.
- (3) Only one of the objects is a magnet.
- (4) The unlike poles of the 2 objects are facing each other.

27. Elroy has 4 identical boxes, A, B, C and D. Each box contains some items of the same mass. Using a U-shaped magnet, he tries to drag box A across the table as shown below.

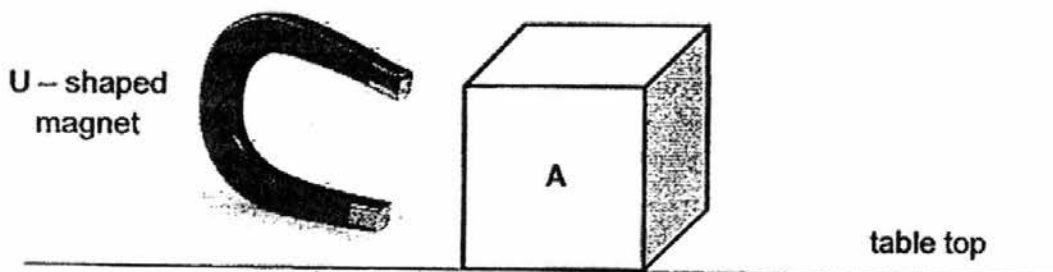

He repeated the experiment with boxes, B, C and D.

Out of the 4 boxes, A, B, C and D, he was only able to drag Boxes, C and D, across the table with his U-shaped magnet.

Which of the following objects are likely to be found in each of these boxes?

	A	B	C	D
(1)	Iron nails	Cotton wool	Silver coins	Cotton wool
(2)	Silver coins	Iron nails	Cotton wool	Steel clips
(3)	Cotton wool	Silver coins	Iron nails	Steel clips
(4)	Cotton wool	Iron nails	Steel clips	Silver coins

28. Clarence carried out an experiment with a lever balance.

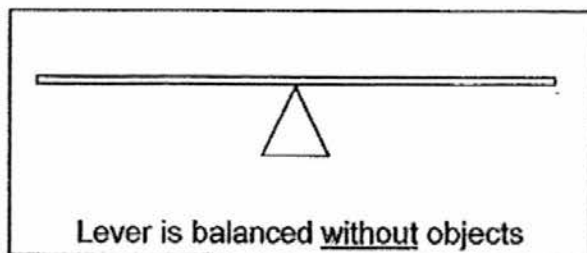

Diagram 1

He placed objects, X, Y and Z, onto the balance as shown in diagram 2.

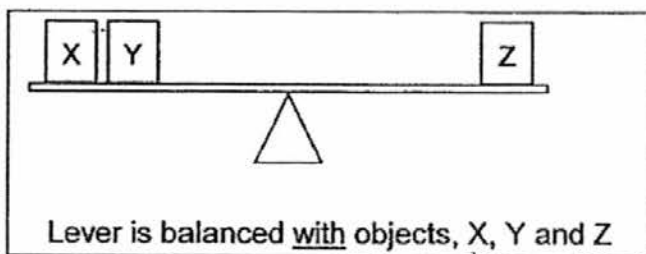

Diagram 2

Which of the following can be concluded from the setup above?

- A Object Z has the greatest volume.
- B Object X and Y have the same mass.
- C Object Y has a smaller mass than Object Z.
- D Object Z has a greater mass than Object X.

- (1) A and B only
- (2) A and D only
- (3) C and D only
- (4) A, C and D only

Name : _____ ()

Class : Primary 4 _____

CHIJ ST NICHOLAS GIRLS' SCHOOL



Primary 4
Semestral Assessment 1 – 2016
SCIENCE
BOOKLET B
12 May 2016

Total Time for Booklets A and B: 1 hour 45 minutes

13 questions
44 marks

Do not open this booklet until you are told to do so.
Follow all instructions carefully.
Answer all questions.

This paper consists of 15 printed pages.

Booklet A	56
Booklet B	44
Total	100

Parent's Signature/Date

Section B (44 marks)

For questions 29 to 41, write your answers in this booklet.

The number of marks available is shown in the brackets at the end of each question or part question.

29. Refer to the diagram below.

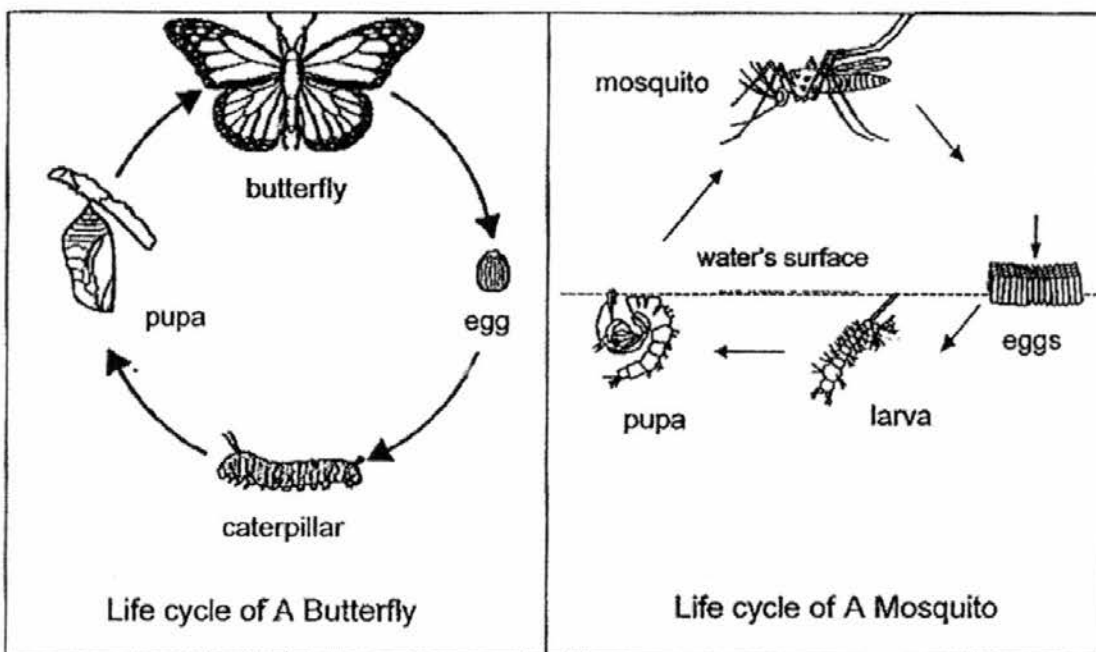

(a) State a difference in the life cycles of the two insects shown above. [1]

(b) Both the caterpillar and mosquito larva moult and shed their outer coverings as they grow into adults. Explain why this happens. [1]

(c) At a certain stage in their life cycles, the butterfly and mosquito are considered to be pests. Explain why this is so. [2]



30. Alif made some statements about the plants shown below.



Plant A



Plant B

(a) State whether the statements are true or false and give a reason for your answer. [2]

	Statements	True/False	Reason
(i)	Plant A is a flowering plant although it does not have flowers.		
(ii)	Plant B is a non-flowering plant as it does not have flowers.		

(b) Draw the life cycle of part A in the box below. [1]

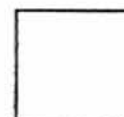
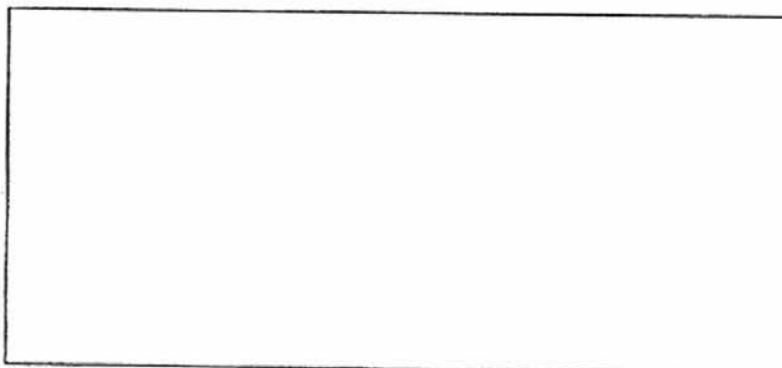

31. Desmond placed similar toads into three set-ups, A, B, and C, as shown in the diagram below.

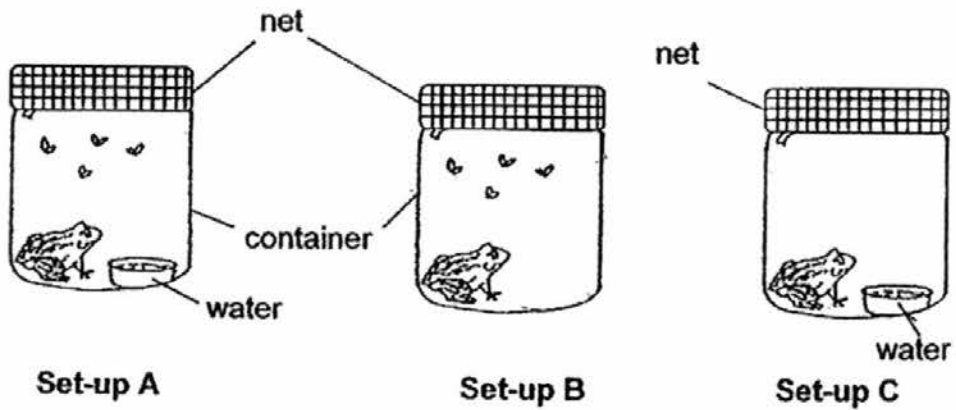

- (a) If Desmond wanted to find out if a toad needs water to survive, which 2 set-ups should he use? [1]

- (b) Why did Desmond use a net to cover the containers instead of a metal or plastic lid? [1]

- (c) If Desmond wanted the toad in set-up B and C to live longer, what changes could he make to the set-ups? [1]

Set-ups	Changes to be made in the set-up
B	
C	

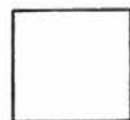

32. Observe the animal shown below.

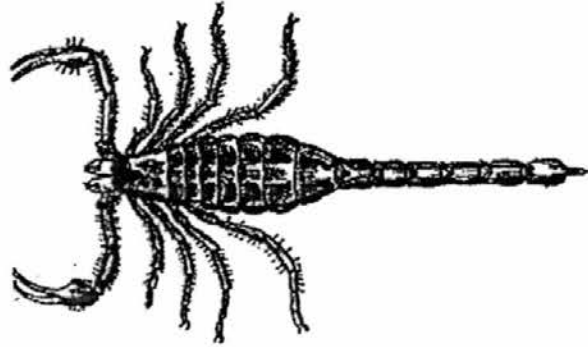

Scorpion

(a) State two reasons why the scorpion is not an insect. [2]

(i)

(ii)

(b) The diagram below shows a beetle laying eggs.



Explain how laying many eggs helps the beetle during reproduction.

[1]



33. Prakash studied what happens to the mass of the seed leaves as a seed germinates and develops into a seedling.

He presented his results in a graph as shown below.

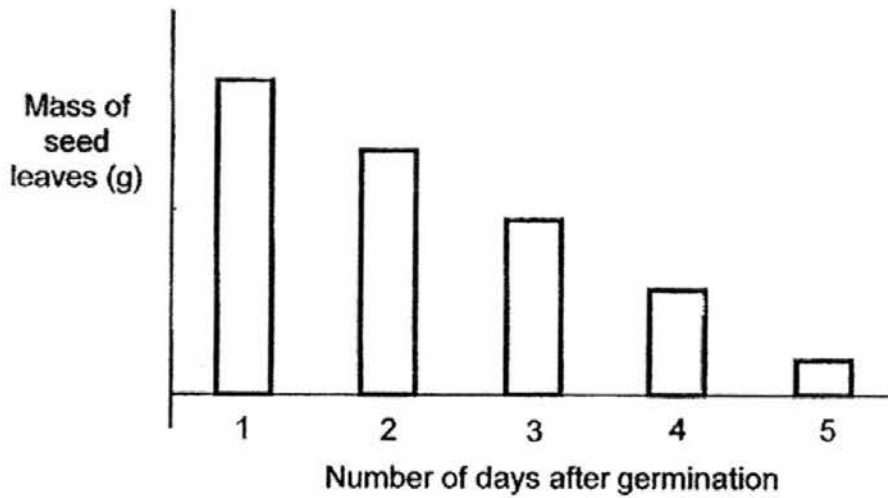

- (a) State the relationship between the number of days after germination and the mass of the seed leaves. [1]

- (b) How did the seedling get its food after Day 5? [1]

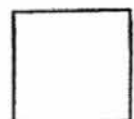

34. The diagram below shows two animals, a frog and a crocodile.

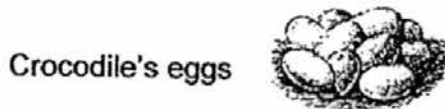
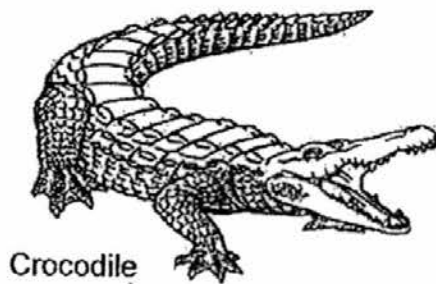

- (a) State a similarity and a difference between the characteristics of a frog and the crocodile. [Do not compare the outer covering of the eggs and reprocion methods.] [2]

Similarity:

Difference:

- (b) The frog's egg is covered by a jelly-like substance whereas the crocodile's egg is covered by a hard shell. Give one reason how this helps the two organisms. [1]

- (c) The tadpole has a different breathing method as compared to the adult frog. Explain why is this so [1]

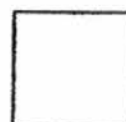

35. Darius carried out an experiment as shown below. He placed different materials between the lighted torch and a light sensor which is connected to the data logger as shown in the diagram below.

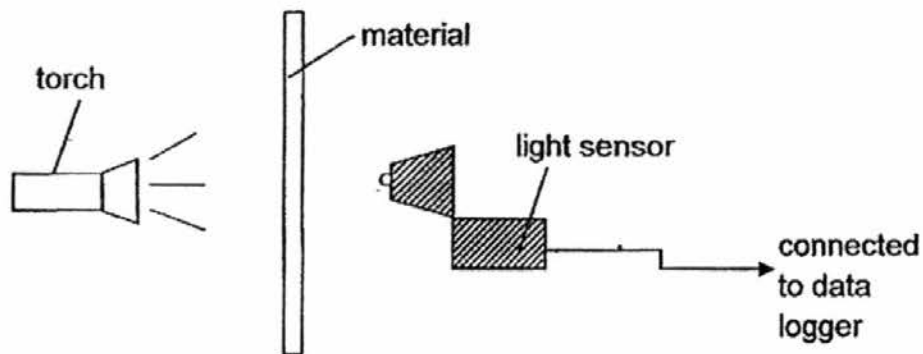

The amount of light that passed through the different materials was recorded in the table below:

	Materials			
	A	B	C	D
Amount of light detected (lux)	20	100	0	60

- (a) What is the aim of Darius' experiment? [1]

- (b) Darius wanted to select materials to make a sunglass lens and a spectacle lens. Which material, A, B, C or D, should he choose? Give a reason for your answer. [2]

	Material chosen	Reason for your choice
Sunglass lens		
Spectacles lens		

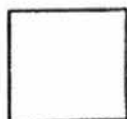

Isaac placed four cardboards, A, B, C and D, in a straight line as shown below. He punched a similar hole in each of the cardboards. He then placed a lighted lantern at the end of the cardboards and tried to view the lantern through the holes from the other end.

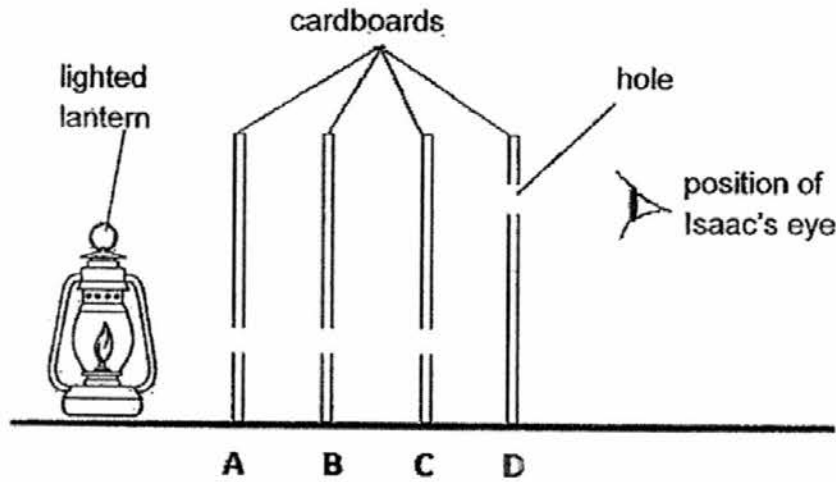

- (c) Would Isaac be able to see the light from the lantern from his position as shown in the diagram above? Explain your answer. [1]

- (d) Isaac placed 2 mirrors in the same set-up to help him see the lantern. In the diagram below, one mirror has been drawn for you. Complete the setup by drawing the second mirror. [1]

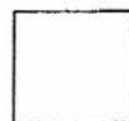
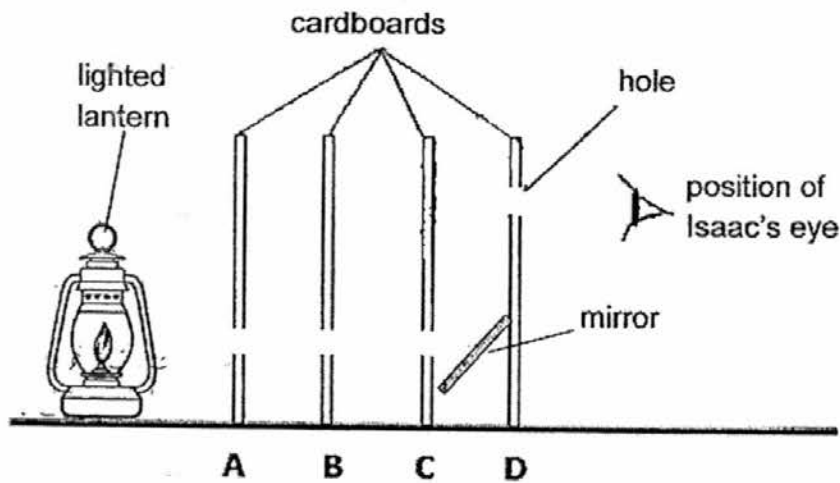

36. In the diagram below, Shane filled a measuring cylinder with 25cm^3 of sand.

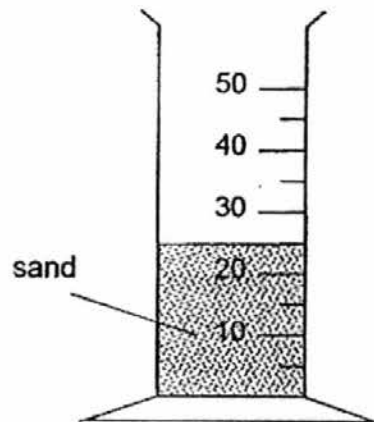

- (a) He then poured 25cm^3 of water into the same measuring cylinder.

What would be the total volume of sand and water shown in the measuring cylinder? Tick your answer in the table below.

Volume of water	Tick (✓)
Above 50cm^3	
At 50cm^3	
Below 50cm^3	

[1]

- (b) Explain your choice in (a).

[2]

- (c) Shane said that sand is a liquid as it takes the shape of the cylinder. Give a reason why Shane was wrong to make this statement.

[1]

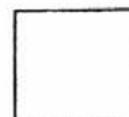

37. Anthony set up the experiment below.

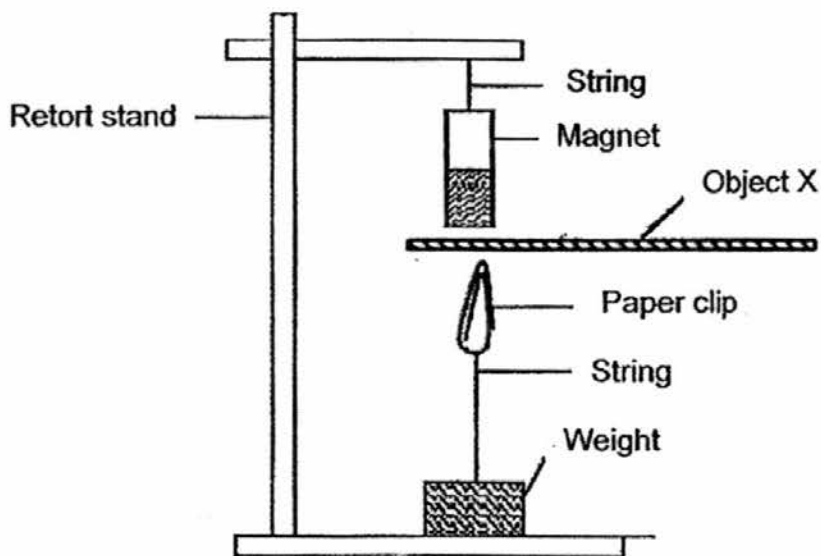

When object X is placed between the magnet and the paper clip, the paper clip remains at the same position.

(a) What type of material could object X be made of ? [1]

(b) When the thickness of object X was increased, the paper clip dropped. Explain this observation. [1]



38. Vincent wanted to find out which type of material, A, B and C, was the most suitable for making the canopy of an umbrella.

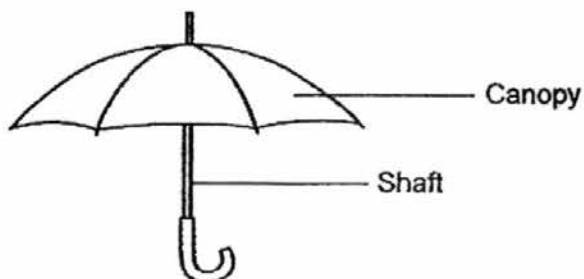

He weighed each piece of material before and after soaking it in a basin of water. The results were recorded in the table below.

Material	Mass of material before soaking in water (g)	Mass of material after soaking in water (g)
A	25	45
B	25	25
C	25	55

- (a) Which material, A, B or C, is the most suitable for making the canopy of an umbrella? Explain why. [1]

- (b) Suggest a material for the shaft of the umbrella and give 2 reasons for your choice. [2]

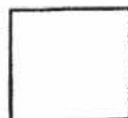

39. Keith used a wooden block and cut out a triangular shape in the centre as shown below. He then shone a torch from 2 different positions, X and Y.

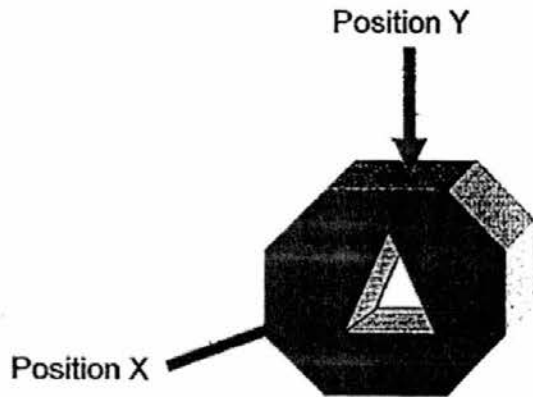

- (a) In the space provided, sketch and shade the shadow cast when a torch is shone from position X and Y. [2]

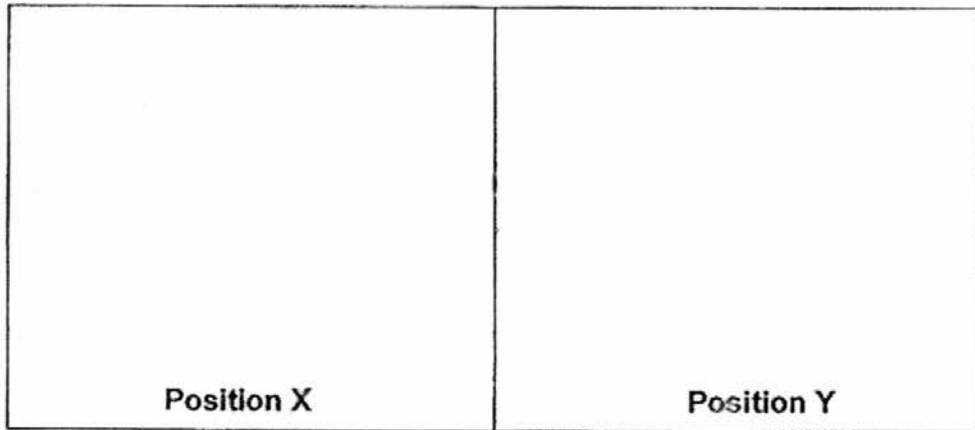

- (b) In the diagram below, Andrew could see the pot of flower. Draw light rays to show how the lamp acted as a source of light allowed him to see pot of flower. [1]

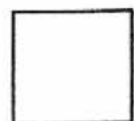
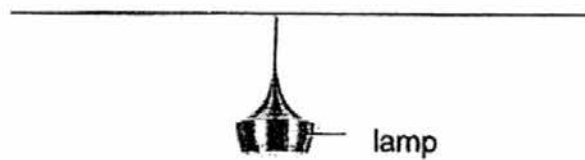

40. In a Science experiment, Nora poured 10ml of oil into the funnels of set-ups, A and B, respectively.

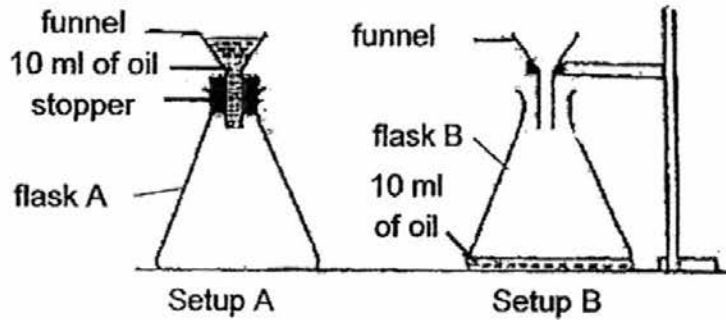

Nora noticed that the oil did not flow into flask A easily, but it flowed into flask B at a faster rate.

(a)

[2]

Miranda did the same experiment using the same apparatus. However, her result for flask A was different from Nora's result as shown below.

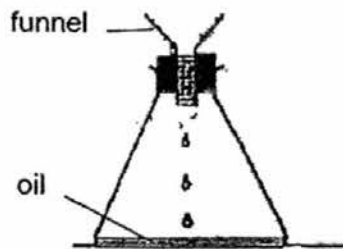

- (b) Which of the following reason(s) likely caused Miranda's result to be different from Nora's result? Tick (✓) the appropriate box or boxes.

[2]

	Reason	Tick (✓)
(i)	Miranda used less oil.	
(ii)	Miranda's stopper was loose.	
(iii)	Miranda poured the oil in slowly.	
(iv)	Miranda poured the oil in quickly.	



41. John conducted an experiment below. He noted that the 3 ring magnets were at a distance from one another.

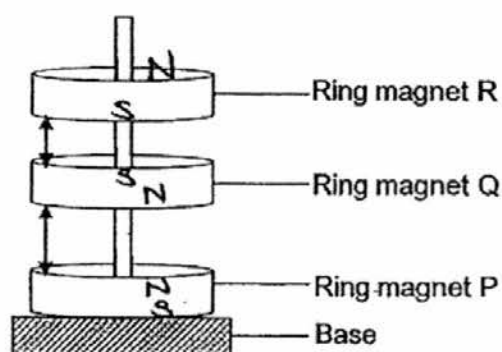

He then

- (a) What would

[1]

Amelie wanted to make a magnet from an iron nail by using the stroking method.

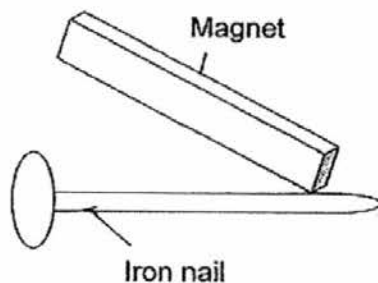

She stroked the iron nail with the magnet more than 30 times, but still could not get the iron nail to attract any paper clips.

- (b) State a possible reason why .

[1]

- (c) What is another method that Amelie can use to magnetise the iron nail?

2]

End of Booklet B

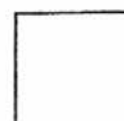

EXAM PAPER 2016 (P4)

SCHOOL : CHIJ

SUBJECT : SCIENCE

TERM : SA1

Q1	Q2	Q3	Q4	Q5	Q6	Q7	Q8	Q9	Q10
2	3	1	4	1	1	3	2	2	4
Q11	Q12	Q13	Q14	Q15	Q16	Q17	Q18	Q19	Q20
1	3	2	3	1	4	4	2	3	1
Q21	Q22	Q23	Q24	Q25	Q26	Q27	Q28		
1	2	2	3	4	1	3	3		

29)a)The mosquito lay eggs in water but the butterfly lay eggs on land.

b)As the larva of the organisms eats, they grow until they become too big for their outer covering. They grow a new outer covering and shed the old ones.

c)When the butterfly is a caterpillar, it feeds on crops and the mosquito sucks people's blood.

30)a)i)True / Plant A has fruits and the fruits are developed from flowers.

ii>false / Some flowers only bloom under suitable conditions or seasons.

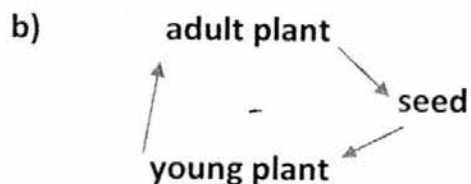

31)a)Set-ups A and B.

b)So that air can go in the container and are holes for the frogs to breathe.

c)B : Put water in it.

C : Put files in it.

32)a)i)It has eight legs and insects have six legs.

ii)It does not have three body parts and insects have three body parts.

b)The beetle species will not be extinct and the eggs will have higher chances of survival as they reach adulthood.

33)a)As the number of days after germination increases, the mass of the seed leaf decreases.

b)The leaves of the seedling make food for the seedling after Day 5.

34)a)Similarity: They both have four legs.

Difference: The frog breathe through moist skin while the crocodile breathe through lungs.

b)The jelly-like substance and the hard shell can protect the frog's and the crocodile's eggs.

c)The tadpole lives in water while the frog is an amphibian, which lives on both land and in water.

35)a)To see the amount of light that passed through the different materials.

b)A / Sunglass lens need dark materials, but not C, because C does not allow any light to pass through.

B / The spectacles lens must allow most, most light to past through them as people can see things properly.

c)No, the holes are not in a straight line and light travels in a straight line.

35)d)

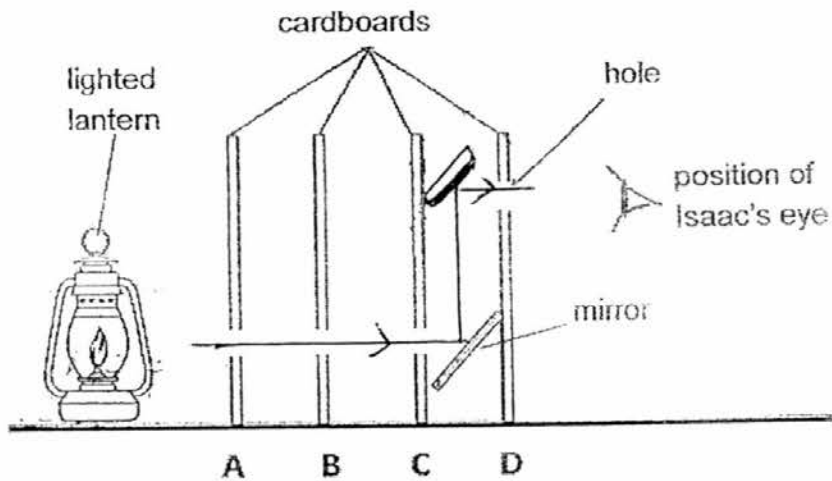

36)a) Below 50cm^3

b) Sand occupies less space than 25cm^3 water occupies space between the grains of sand so the total volume will be less than 50cm^3 .

c) Sand is a solid as solid has a definite volume, a definite shape and it cannot be compressed.

37)a) Wood.

b) The magnet cannot attract the paper clip through the thicker sheet of material X.

38)a) Material B. The more water the material absorb, the heavier they will and Material was still the same mass as before it was soaked in water so the person holding it will not be wet.

b) Metal. It is waterproof and it is strong and stiff.

39)a)

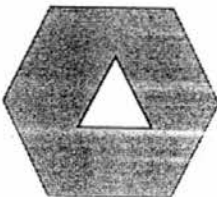

39)b)



40)a)As the stopper on Flask A prevent the air in Flask A from escaping, oil cannot enter the flask to occupy its space. But for Flask B there is no stopper to prevent air from escaping air in Flask B can escape allowing oil to enter Flask B and occupying its space.

b)ii , iii

41)a)Ring magnets R and P were attracted to each other as their unlike poles are facing each other.

b)She did not stroke the same direction.

c)She can connect batteries to a wire and coil the wire around the iron nail. Then she should on the switch.