



MARIS STELLA HIGH SCHOOL (PRIMARY)

SEMESTRAL ASSESSMENT 1

SCIENCE

12 MAY 2016

BOOKLET A

---

NAME: _____ ( )
CLASS: Primary 4 ( )

24 questions

48 marks

Total Time for Booklets A & B: 1 h 30 min

DO NOT OPEN THIS BOOKLET UNTIL YOU ARE TOLD TO DO SO.

FOLLOW ALL INSTRUCTIONS CAREFULLY.

For each question from 1 to 24, four options are given. One of them is the correct answer. Make your choice (1, 2, 3 or 4). Shade the correct oval (1, 2, 3 or 4) on the Optical Answer Sheet (OAS). (24 x 2 marks)

---

- 1 Andy, Ben and Colin made the following statements about the human skeletal system and muscular system.

Andy: Only the skeletal system is needed for movement to take place.

Ben: Only the muscular system is needed for movement to take place.

Colin: Both skeletal and muscular system are needed for movement to take place.

Whose statement is/are correct?

- (1) Andy only
  - (2) Ben only
  - (3) Colin only
  - (4) Andy and Ben only
- 2 The diagram below shows the life cycle of an animal.

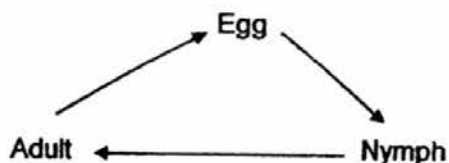

Which animal most likely have the same life cycle as the one shown above?

- (1) Frog
- (2) Beetle
- (3) Chicken
- (4) Grasshopper

3 The diagram below shows the digestive system of a human body.

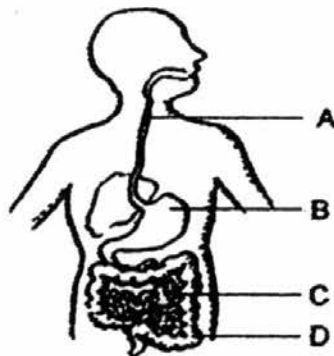

In which part of the digestive system does digested food get absorbed into the bloodstream?

- (1) A
- (2) B
- (3) C
- (4) D

4 The diagrams below show the life cycles of two different insects, X and Y.

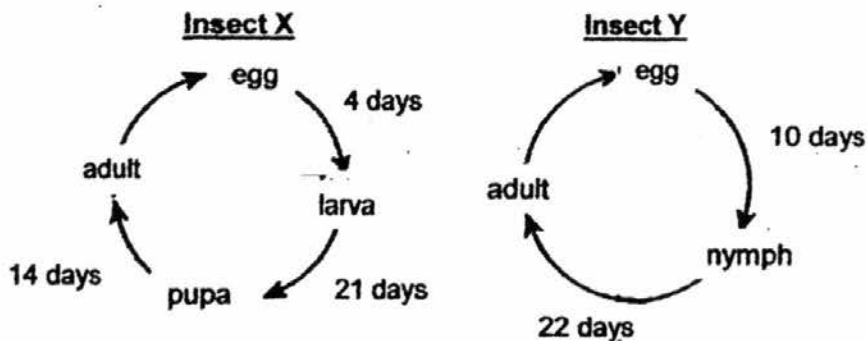

Based only on the information given, which of the following statements is true?

- (1) Insect X has a longer life span than Insect Y.
- (2) The young of both insects do not resemble their parents.
- (3) Insect X has a 4 life cycles while Insect Y has 3 life cycles.
- (4) Insect X takes a shorter time to hatch from an egg than Insect Y.

5 Study the classification chart below.

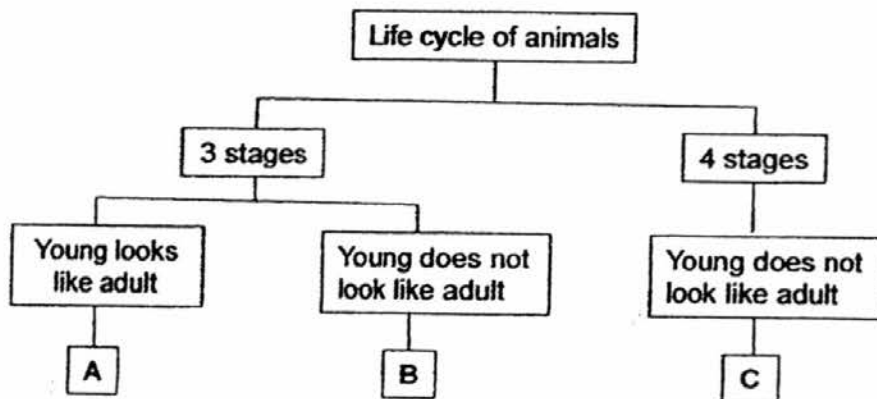

Which of the following best represents A, B and C?

	A	B	C
(1)	Grasshopper	Frog	Mosquito
(2)	Human	Beetle	Butterfly
(3)	Frog	Butterfly	Mosquito
(4)	Human	Grasshopper	Beetle

6 The diagram below shows a plant. The leaves of the plant close when they are touched.



This shows that the plant is a living thing because it can \_\_\_\_\_.

- (1) die
- (2) grow
- (3) reproduce
- (4) respond to changes around them

- 7 The table below shows the characteristics of two animals E and F.

Animal	Number of Legs				Method of Reproduction	
	0	2	4	6	Lays eggs	Gives birth to young alive
E			✓			✓
F	✓				✓	

What outer body coverings will animals E and F most likely have?

	Animal E	Animal F
(1)	hair	scales
(2)	feathers	hair
(3)	moist skin	hair
(4)	hair	feathers

- 8 The following table shows the characteristics of organisms A, B, C, D and E.

Characteristics	A	B	C	D	E
It responds to changes in its surroundings.	x	✓	✓	✓	✓
It can only be seen through a microscope.	✓	x	✓	x	✓
It can move freely on its own.	x	x	✓	✓	x

Which of the organisms, are micro-organisms?

- (1) B and D only
- (2) C and D only
- (3) C and E only
- (4) A, C and E only

- 9 Study the classification chart below.

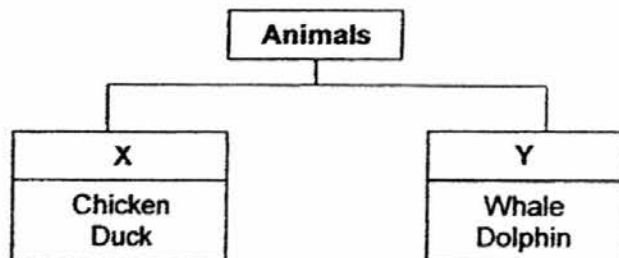

Which of the following is most likely headings of animals in groups X and Y?

	X	Y
(1)	Have feathers	Have scales
(2)	Lay eggs	Give birth to young alive
(3)	Hard outer covering	Have hair
(4)	Breathe through lungs	Breathe through gills

- 10 Which of the following items make use of magnets to work?

- A Compass
- B Refrigerator
- C Plastic Ruler

- (1) A only
- (2) A and B only
- (3) B and C only
- (4) A, B and C only

- 11 The diagram shows what happened to 4 different bars, E, F, G and H, when they were suspended on a string next to each other.

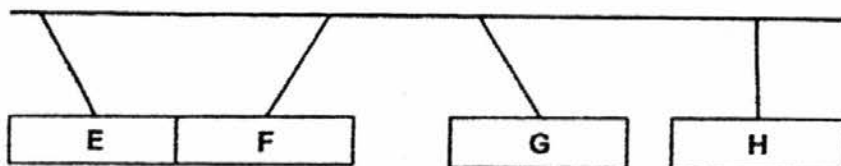

Which of the following statements about the 4 bars is correct?

- A E is a magnetic object.
- B F is a non-magnetic object.
- C G is a magnet.
- D H is a non-magnetic object.

- (1) A and D only
- (2) B and C only
- (3) A, B and C only
- (4) A, C and D only

- 12 The diagram below shows two ring magnets suspended on top of another on a wooden base. A, B, C and D are the poles of the suspended magnets.

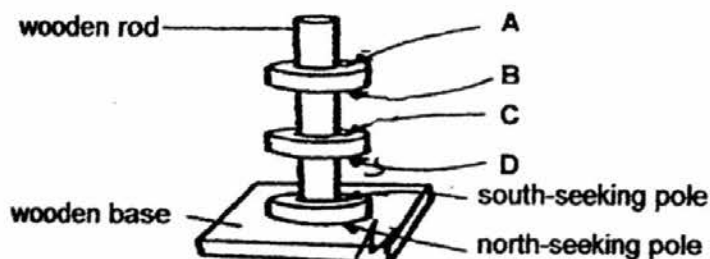

Which one of the following pairs are like poles?

- (1) A and B
- (2) A and C
- (3) B and C
- (4) C and D

13 Five bar magnets with their poles marked A to J can be arranged as shown below.

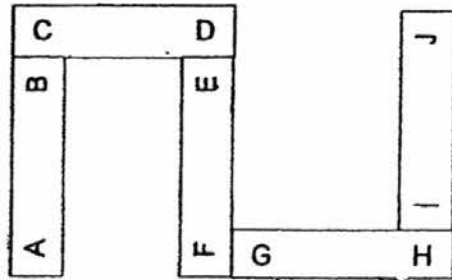

Which of the following shows a possible arrangement of two of the magnets?

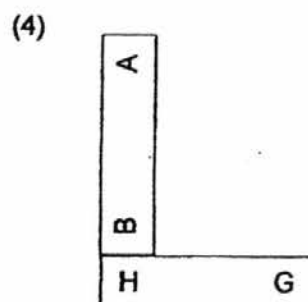
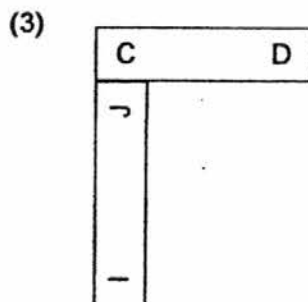
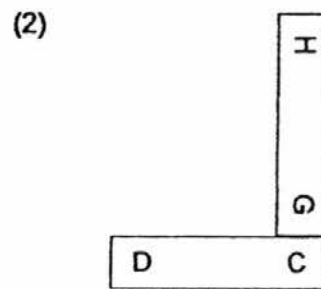
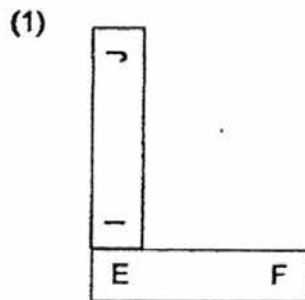



14 Study the electromagnet shown below.

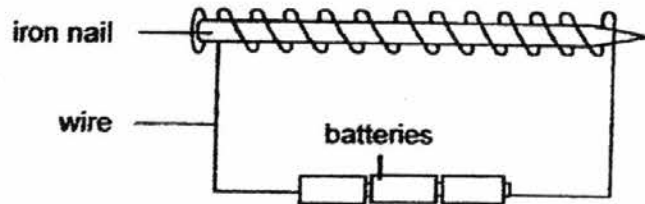

Which one of the following changes will decrease the number of pins attracted to the electromagnet?

- A Increase the number of batteries
- B Decrease the number of batteries
- C Replace the iron nail with an aluminium nail
- D Increase the number of coils of wire around the iron nail

- (1) A and D only
- (2) B and C only
- (3) A, B and C only
- (4) A, C and D only

15 Which one of the following correctly shows the direction of a freely suspended bar magnet when it has come to a stop?

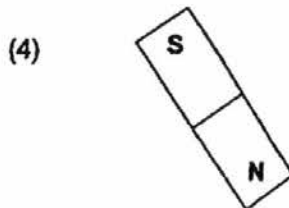
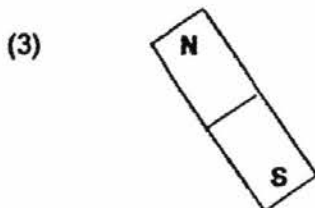
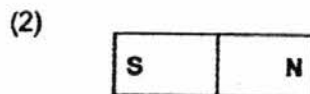
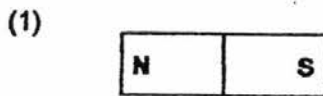

16 Study the diagram below.

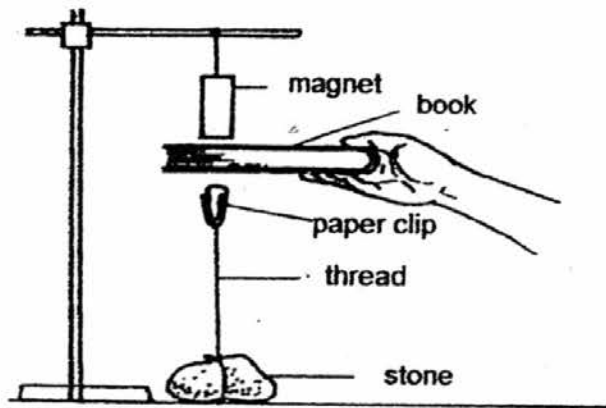

What does the above demonstration show about magnetism?

- (1) Magnetism from paper clip attracted the book.
- (2) Magnetism from the book attracted the paper clip.
- (3) Magnetism can pass through a non-magnetic object.
- (4) Magnetism cannot pass through a non-magnetic object.

17 Which of the following is/are not matter?

- A Air
  - B Heat
  - C Light
  - D Shadow
- (1) A only
  - (2) B and C only
  - (3) A, C and D only
  - (4) B, C and D only

- 18 Mrs Lim used a pump to remove the air from an air-tight plastic bag packed with clothes. She recorded the results in the table shown below.

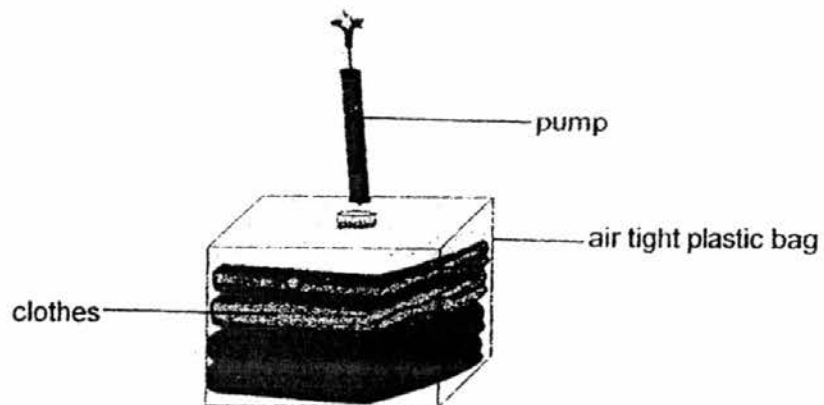

Number of pumps	Mass of the bag of clothes (g)
0	900
10	890
20	880

Based only on the information from Mrs Lim's experiment, which of the following conclusion(s) is/are possible?

- A Air has mass.
  - B Air has volume.
  - C Air does not have a definite shape.
- (1) A only  
(2) B only  
(3) A and C only  
(4) A, B and C

- 19 The diagram below shows a communicating vessel. The openings of A and D are covered with stoppers. 500ml of water is poured into the vessel through opening B.

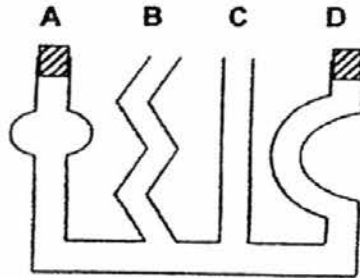

Which diagram shows the final water level in the vessel after all the water is poured in?

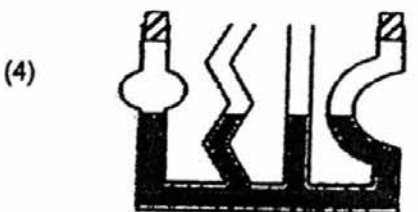
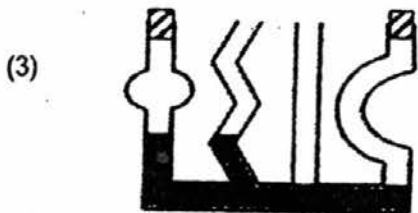
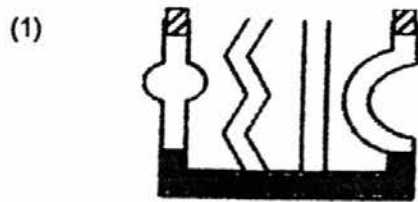

- 20 The diagram below shows a bottle filled with Substance P and put into 3 different positions.

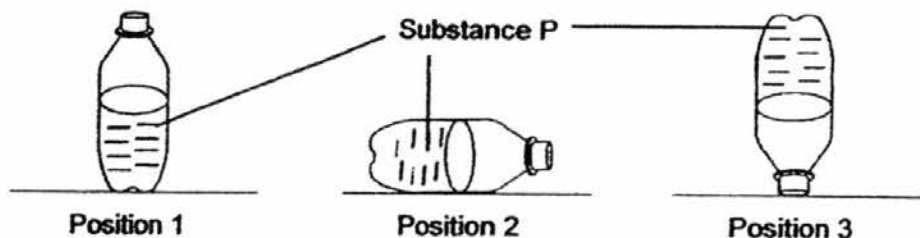

Based only on the demonstration above, which of the following statement(s) is/are **incorrect** about Substance P?

- A Substance P has mass.
- B Substance P has indefinite shape.
- C Substance P has indefinite volume.

- (1) B only
- (2) A and B only
- (3) B and C only
- (4) A, B and C

- 21 The diagram below shows four objects placed on different lever balances.



Arrange the objects according to their masses from the smallest to the biggest.

- (1) A, B, C, D
- (2) B, A, D, C
- (3) C, B, A, D
- (4) D, A, B, C

- 22 Adam was asked by his teacher to conduct an experiment to find the volume of a small marble of  $5\text{cm}^3$ .

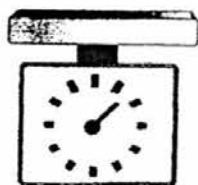

A

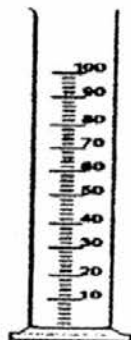

B

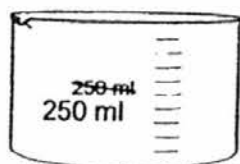

C

Which of the apparatus below is/are most suitable to conduct the experiment?

- (1) A only
  - (2) B only
  - (3) B and C only
  - (4) A, B and C
- 23 Which one of the following properties is correct of water and stone?
- (1) Both take up space.
  - (2) Both cannot be seen.
  - (3) Both have indefinite shape.
  - (4) Both have indefinite volume.

24 Study the classification table below.

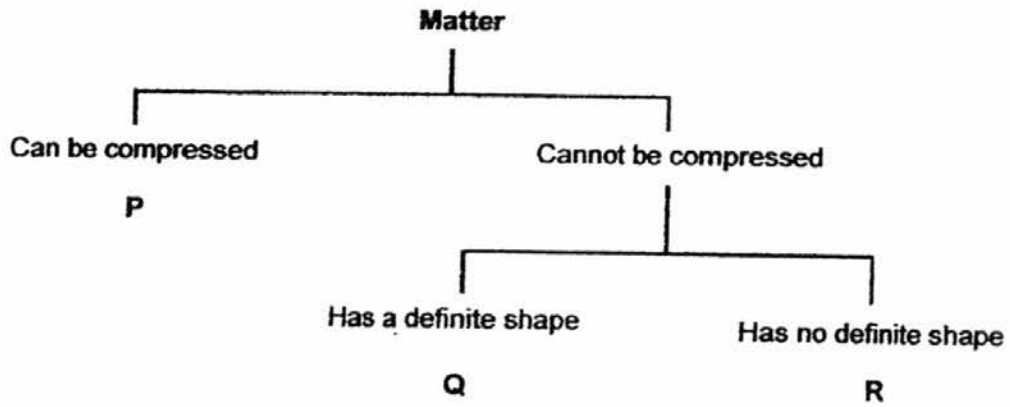

Which of the following correctly represents P, Q and R?

	P	Q	R
(1)	liquid	gas	solid
(2)	gas	solid	liquid
(3)	solid	liquid	gas
(4)	gas	liquid	solid

End of Booklet A



**MARIS STELLA HIGH SCHOOL (PRIMARY)**  
**SEMESTRAL ASSESSMENT 1**  
**SCIENCE**  
**12 MAY 2016**  
**BOOKLET B**

NAME: \_\_\_\_\_ ( )

CLASS: Primary 4 ( )

10 questions

32 marks

Total Time for Booklets A & B: 1 h 30 min

DO NOT OPEN THIS BOOKLET UNTIL YOU ARE TOLD TO DO SO.  
FOLLOW ALL INSTRUCTIONS CAREFULLY.

BOOKLET A: \_\_\_\_\_ / 48

BOOKLET B: \_\_\_\_\_ / 32

TOTAL: \_\_\_\_\_ / 80

PARENT'S SIGNATURE: \_\_\_\_\_



For questions 25 to 34, write your answers in this booklet. The number of marks available is shown in brackets [ ] at the end of each question or part question. (32 marks)

25 The diagram below shows the life cycles of Animal A and Animal B.

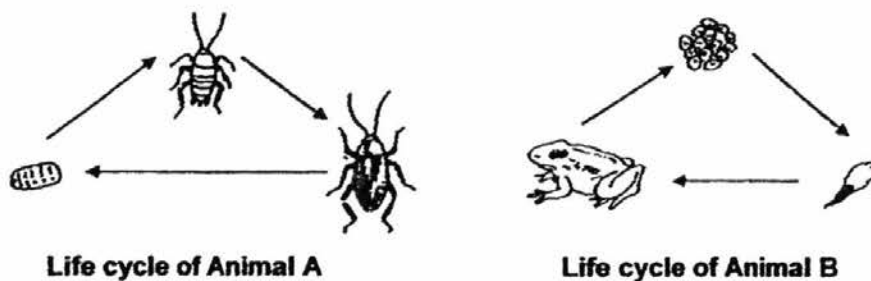

(a) Based only on the diagram, state one similarity and difference between the two life cycles shown. [2]

Similarity: \_\_\_\_\_  
\_\_\_\_\_

Difference: \_\_\_\_\_  
\_\_\_\_\_

(b) In what way is the tadpole of a frog different from the adult frog? [1]

\_\_\_\_\_  
\_\_\_\_\_

	3
--	---

26. James placed a seed in two containers, A and B, and left them in a warm area. After a few days, the seed in container A germinated but the seed in container B did not.

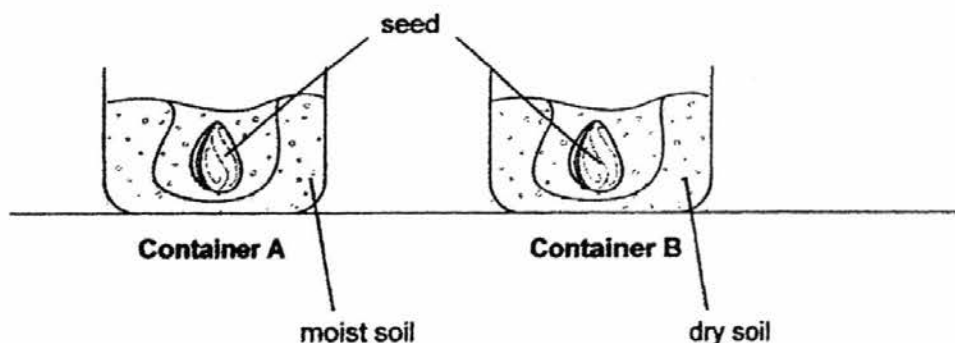

- (a) Give a reason why the <sup>seed</sup> ~~bean~~ in container A germinated. [1]

- (b) Put a tick (✓) in the appropriate boxes. [2]

	Statement	True	False
(i)	Seed coat protects the seed.		
(ii)	Most flowering plants have a three-stage life cycle – seed, young plant and adult plant.		
(iii)	As the seed germinates, the shoot appears first before the roots grow out.		
(iv)	Seed leaves provide the embryo in the seed with food.		

- 27 The graph below shows the amount of undigested food in our digestive system as it leaves different parts of the human digestive system, A to E. The amount of undigested food eaten by the person is 500g.

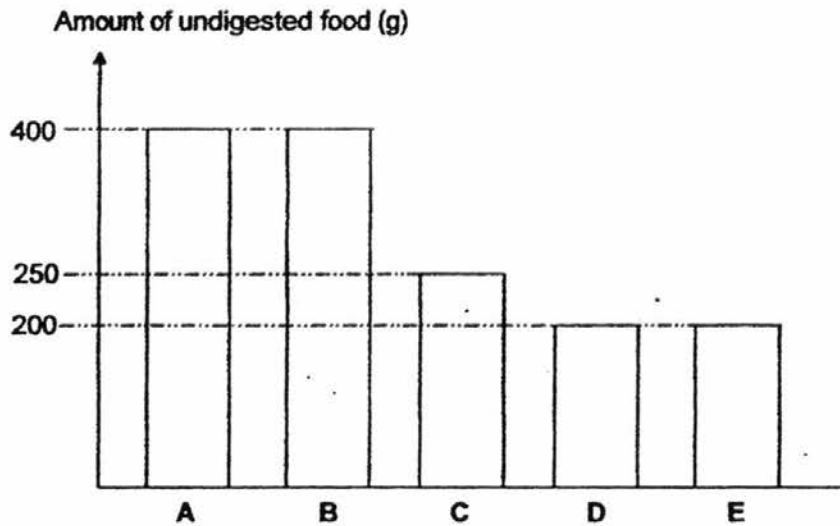

- (a) Based on the graph, which parts (A, B, C, D and E) of the digestive system do digestion occurs? [1]

---

- (b) John is having constipation. He noticed that his faeces are very dry. Name the organ in the digestive system that is causing this problem. [1]

---



- 28 Jethro set up two boxes, A and B. He placed some living things in one box and an equal number of non-living things in another box. Both boxes were provided with equal amount of air, food and water.

Jethro recorded the number of things in both boxes over 2 weeks and drew the graph below.

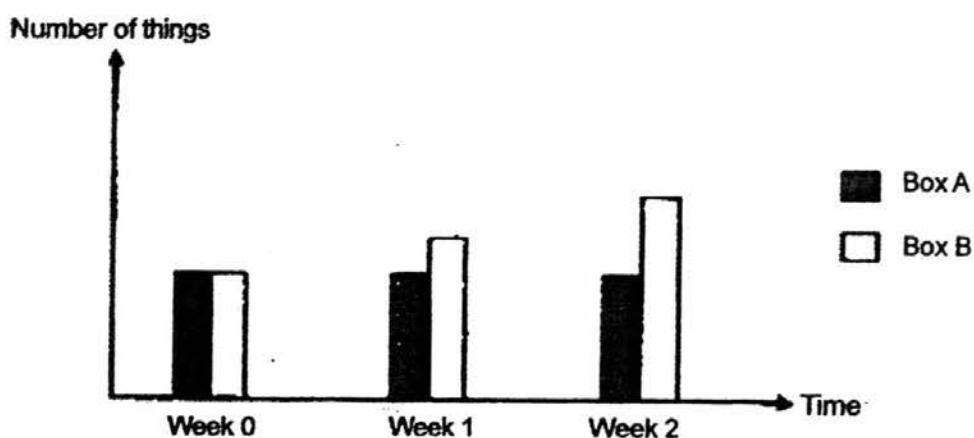

- (a) Based on the graph above, which box (A or B) contained living things? [1]

---

- (b) State the characteristic of living things that helped you to arrive at your answer in (a). [1]

---

---

29 Jamie suspended an iron nail freely midway between 2 identical iron bars, A and B.

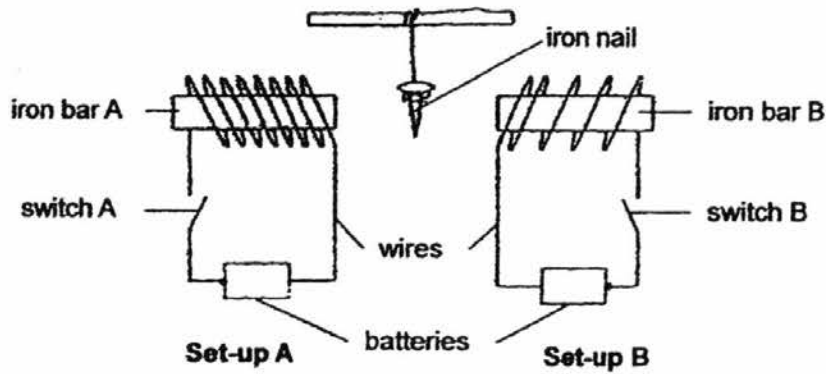

(a) What will Jamie observe when she turned on both switches A and B? [1]

---

(b) Explain her observation in (a). [2]

---

---

(c) What will Jamie observe about the nail if she changed the iron nail into an aluminium nail? Give a reason for your answer. [1]

---

---



- 30 Tom conducted Experiment A with a bar magnet and some metal pins. He brought the metal pins close to the different positions of the bar magnet. The number of metal pins attracted to the different positions of the bar magnet were recorded in the table below.

Position	Number of metal pins attracted
A	30
B	28
C	5

**Experiment A**

- (a) Label the positions, A, B and C, in the boxes provided.

[1]

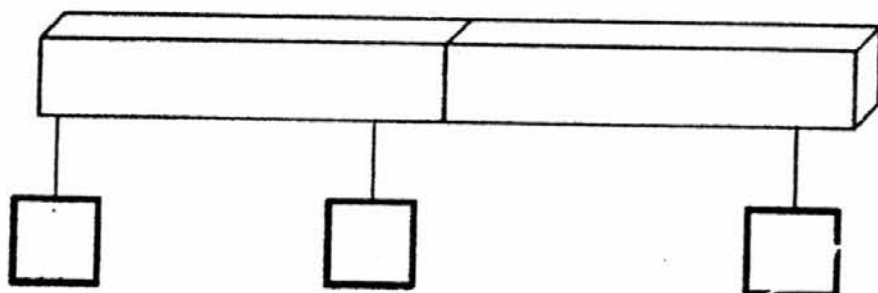

	1
--	---

Tom then conducted Experiment B. He placed a stiff white sheet of paper on top of the bar magnet and sprinkled some iron filings on it as shown in Diagram A.

**Experiment B**

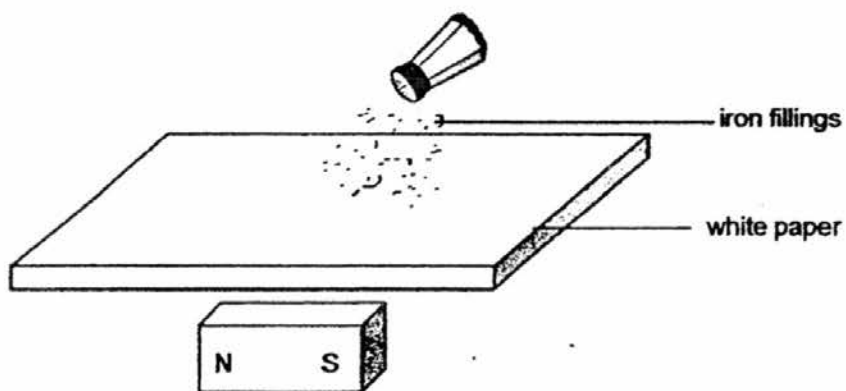

A pattern is formed by the iron filings as shown in Diagram B.

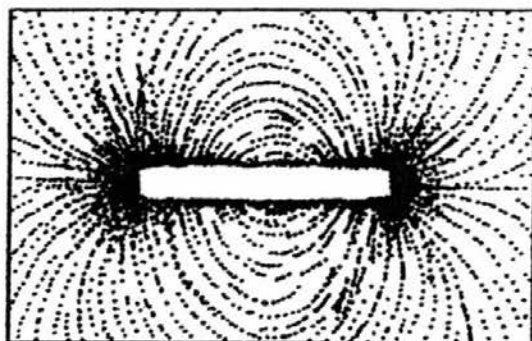

(b) State two properties of magnets demonstrated in experiments A and B. [2]

(i) \_\_\_\_\_

(ii) \_\_\_\_\_



(Go on to the next page)

- 31 Tobey set up an experiment as shown below. He wanted to find out if the number of times he stroked the iron bar with the magnet would affect the distance from which the safety pin would be attracted to the iron bar. The results are shown below.

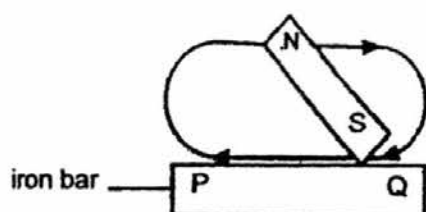

Number of strokes	Distance from iron bar (cm)
20	5
25	8
30	11
40	14

- (a) In the diagram below, the iron bar was magnetised and remained in the same position.

Identify and label the North and South poles of the iron bar after it has been magnetised. Use 'N' for North pole and 'S' for South pole. [1]

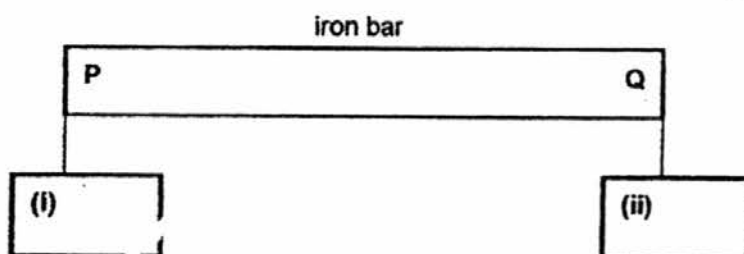

- (b) Based on the results table, what is the number of strokes that resulted with an iron bar having the strongest magnetism? [1]

---

- (c) What is the relationship between the number of strokes and the magnetism of the temporary magnet? [1]

---



---

	3
--	---



- 32 John set up the experiment as shown below to find out more about the properties of matter. The diagrams below show a glass of water and a glass of ice.

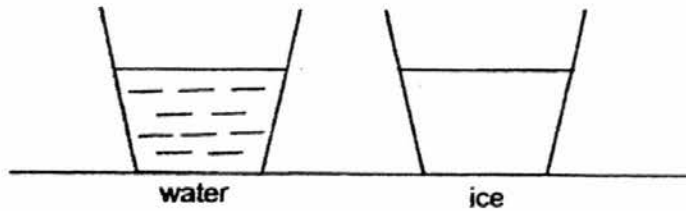

- (a) Draw the level of observations of the level of water and ice after both glasses are tilted. [1]

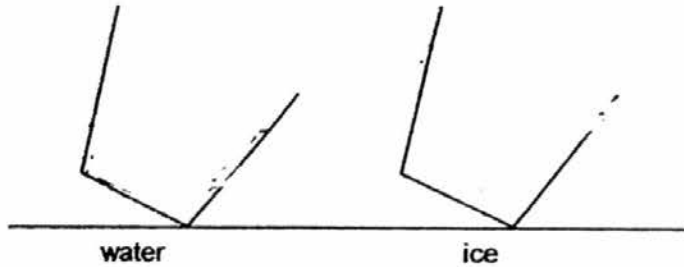

- (b) What properties of matter are shown in (a)? [1]

(i) \_\_\_\_\_

(ii) \_\_\_\_\_



John then set up another experiment below to find out more about the properties of matter. He observed and compared the following syringes.

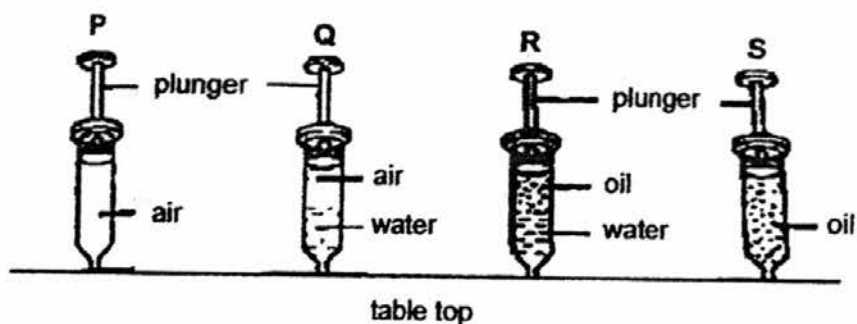

- (c) Which of the plunger(s) (P, Q, R and S) cannot be pushed downwards? [1]

---

- (d) Give a reason for your answer in (c). [1]

---

---

- 33 Allan placed an inflated ball on a weighing scale as shown below. He observed that the mass of the inflated ball was 250g.



Mass: 250g

- (a) Allan then deflated the ball and measured its mass. What would happen to the mass of the ball? [1]

---

- (b) What is the property of air shown in (a)? [1]

---

- (c) The volume of air inside the ball is  $600 \text{ cm}^3$ . Allan pumped in another  $50 \text{ cm}^3$  of air. [1]  
What is the final volume of air in the ball?

---

- (d) What is the property of air shown in (c)? [1]

---

- 34 Leroy used identical marbles and containers for the experiment he conducted as shown below. He compared the distance that each container sunk in water.

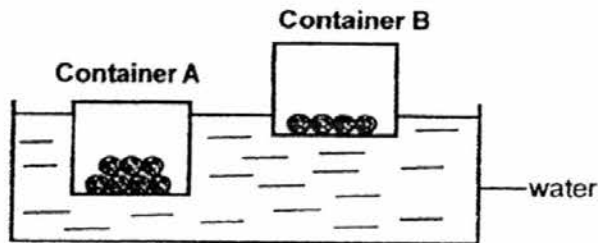

- (a) State the manipulated variable of the experiment. [1]

---

- (b) What is the aim of his experiment? [1]

---

- (c) Name one important variable to be kept the same for the experiment to be a fair test. [1]

---

- (d) Leroy went out on a fishing trip and had a full load of fish. After fishing, he discovered that the boat has sunk deeper into the water.

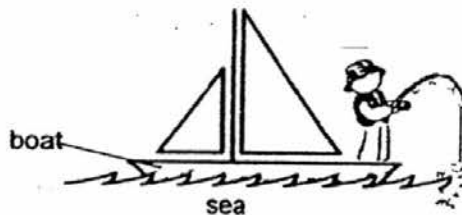

Assuming that there is no damage to the boat, suggest what can be done to cause the boat to float above the water level. [1]

---

End of Booklet B



**EXAM PAPER 2016**

**SCHOOL : MARIS STELLA HIGH SCHOOL**  
**SUBJECT : PRIMARY 4 SCIENCE**  
**TERM : SA1 (MID YEAR EXAM)**

**BOOKLET A**

<b>Q1</b>	<b>Q2</b>	<b>Q3</b>	<b>Q4</b>	<b>Q5</b>	<b>Q6</b>	<b>Q7</b>	<b>Q8</b>	<b>Q9</b>	<b>Q10</b>
3	4	3	4	1	4	1	3	2	2
<b>Q11</b>	<b>Q12</b>	<b>Q13</b>	<b>Q14</b>	<b>Q15</b>	<b>Q16</b>	<b>Q17</b>	<b>Q18</b>	<b>Q19</b>	<b>Q20</b>
4	3	3	2	3	3	4	1	2	1
<b>Q21</b>	<b>Q22</b>	<b>Q23</b>	<b>Q24</b>						
4	2	1	2						

**BOOKLET B**

**Q25(a)** They both have a 3 stage life cycles.

**Q25(b)** The young of animal A resembles its adult but animal B's young does not resemble its adult.

**Q26(a)** It had water, oxygen and warmth

**Q26(b)**

- (i) True
- (ii) True
- (iii) False
- (iv) True

**Q27(a)** A, B & C

**Q27(b)** The large intestine

**Q28(a)** Box B

**Q28(b)** Living things reproduce

**Q29(a)** The iron nail would be attracted by set-up A **Q29(b)** Iron bar A had more coils than the iron bar B, therefore iron bar A would have stronger magnetism than iron bar B and the iron nail would tilt towards set up A.

**Q29(b)** The iron nail would not tilt to anyone of the set ups as aluminum is not a magnetic object therefore it cannot be magnetized and would not attract the iron nail.

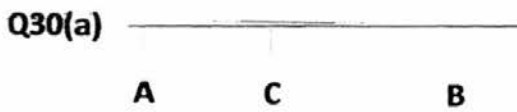

**Q30(b)**

- (i) Magnetism is strongest at its poles.
- (ii) Magnetism can pass through non-magnetic objects

**Q31(a)**

- (i) N
- (ii) S

**Q31(b)** 40 strokes

**Q31(c)** The greater the number of strokes the stronger the magnetism of the magnet

**Q32(a)**



**Q32(b)**

- (i) Liquid does not have a definite shape
- (ii) Solids have definite shape

**Q32(c)** R and S

**Q32(d)** R and S have liquids in them, they have a definite volume. So it cannot be pushed down.

**Q33(a)** Its mass would decrease

**Q33(b)** Air had mass

**Q33(c)**  $600\text{cm}^3$

**Q33(d)** Air can be compressed

**Q34(a)** The number of marbles

**Q34(b)** To find out whether the number of marbles would affect the distance of the container that sink

**Q34(c)** The weight of the marbles

**Q34(d)** Release some fish.