

**CATHOLIC HIGH SCHOOL
PRIMARY 4
SEMESTRAL ASSESSMENT 2, 2010**

SCIENCE

Name: _____ (

Class : Primary 4 _____

Date : 28 Oct 2010

BOOKLET A

30 Questions
60 Marks

Total Time for Booklets A & B : 1 hour 30 minutes

Instructions to Candidates

Do not open this booklet until you are told to do so.
Follow all instructions carefully.
Answer all questions.

Section A: Multiple Choice Questions (60 marks)

For each question from 1 to 30, four options are given. One of them is the most suitable answer. Make your choice (1, 2, 3 or 4) on the Optical Answer Sheet.

1. The table below shows some living things and how they are grouped.

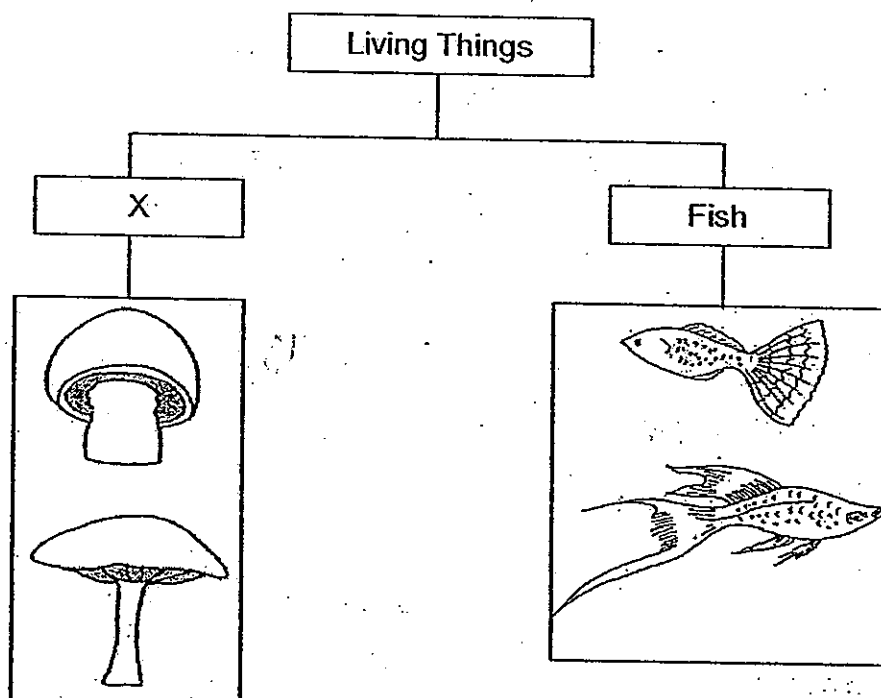

Which one of the following is the most suitable heading for Group X?

- (1) bacteria
- (2) fungi
- (3) insects
- (4) mammals

2. Below are shown four living things.



Four students are asked to choose the odd one out and state a reason for their choice. The table below shows their answers.

Student	Living thing	Reason
Gary	Bat	It gives birth to its young alive but the rest lay eggs for reproduction.
Henry	Crocodile	It cannot fly but the rest can fly.
Jimmy	Dragonfly	It is an insect but the rest are not insects.
Tony	Owl	It is a plant eater but the rest are animal eater.

Which group of students have given the correct reason for their choice?

- (1) Gary and Henry only
- (2) Henry and Jimmy only
- (3) Gary, Henry and Jimmy only
- (4) Gary, Henry, Jimmy and Tony

3. The following diagram shows the different organs of a human system.

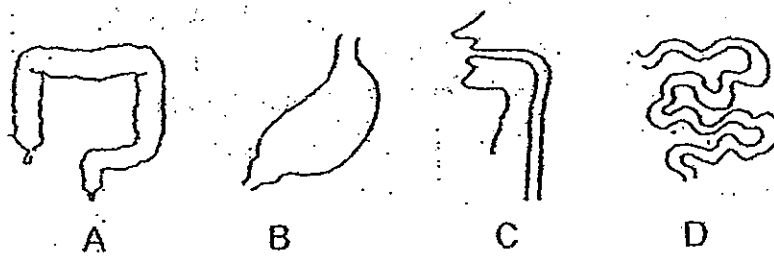

Which one of the following shows the correct path our food takes during digestion?

- (1) C → B → D → A
- (2) C → D → B → A
- (3) C → B → A → D
- (4) C → A → B → D

4. Which one of the following is the function of a leaf on a plant?

- (1) holds the plant upright
- (2) makes food
- (3) takes in mineral salts
- (4) takes in water

5. Stephanie grows a small plant in a glass container. She sets up the experiment as shown below.

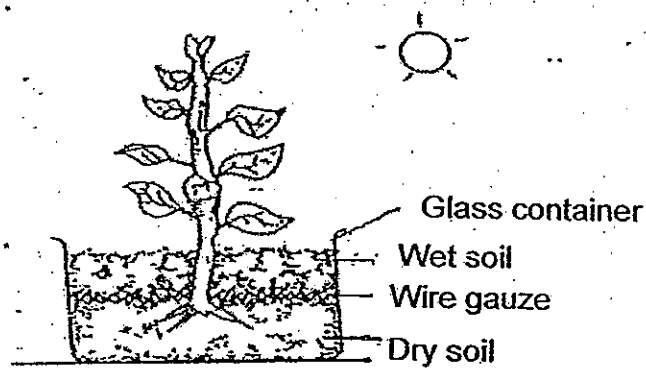

After a few days she observed that the roots of the plant had shown some movement as shown below.

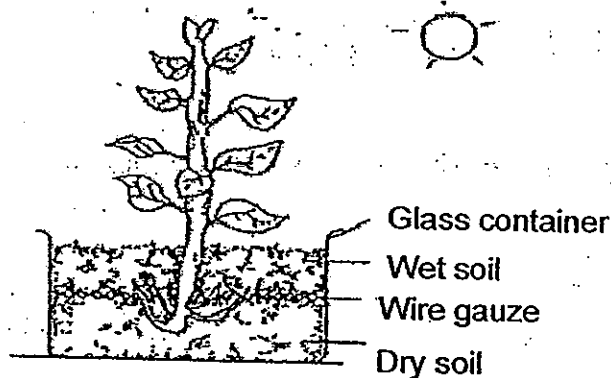

What does this tell us about the characteristics of plants?

- (1) Roots move up to receive light.
- (2) Roots move in search of water.
- (3) Roots respond towards water and light.
- (4) All parts of plants always move upwards.

6. Nora studied the diagram of the digestive system as shown below. She made a table to list the functions of the parts labelled W, X, Y and Z.

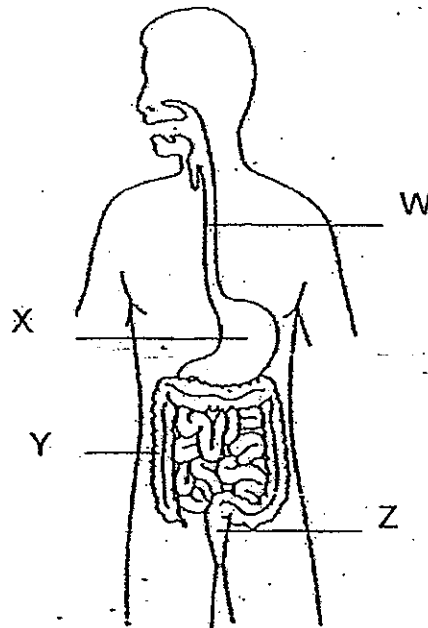

Which part of the digestive system W, X, Y or Z, has the incorrect function?

	Part of the digestive system	Function
(1)	W	A muscular tube which pushes the food that has been swallowed into the stomach.
(2)	X	Absorbs digested food.
(3)	Y	Removes water from undigested food.
(4)	Z	Stores undigested food

7. The diagram below shows the growth of a young plant with two missing stages P and Q.

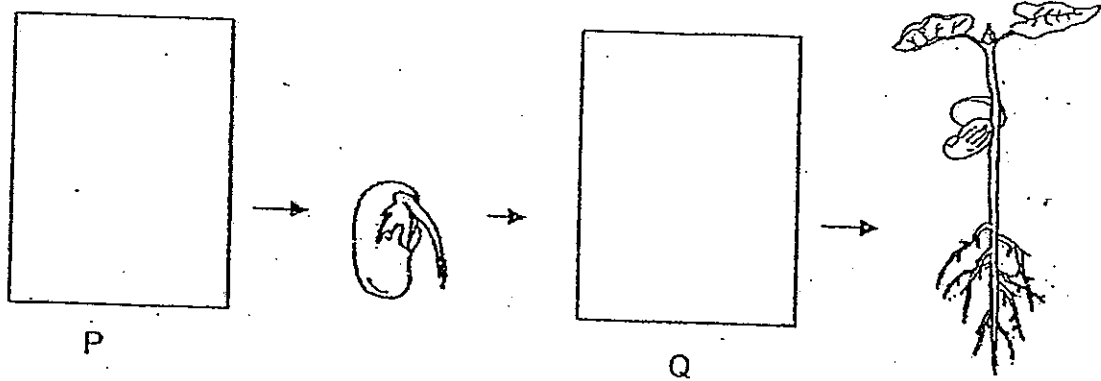

Which one of the following shows the correct stages for stages P and Q?

	P	Q
(1)		
(2)		
(3)		
(4)		

8. Study the concept map below.

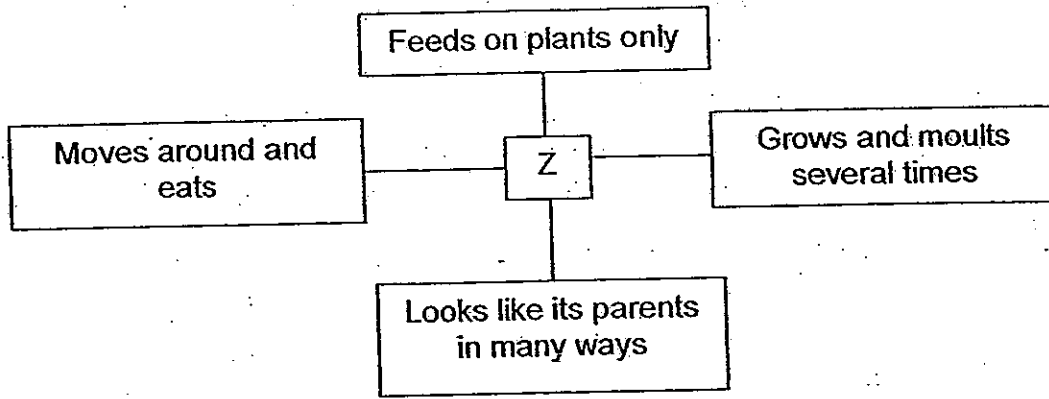

Z is probably the young of a _____.

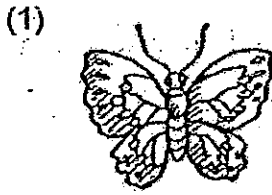

9. Susan conducted an experiment to find out whether the amount of water will affect the growth of seeds. She placed a few seeds in each of the four containers.

The table below shows the amount of water Susan used to water the plants each day. It also shows which containers received air and sunlight.

Container	Amount of water (ml)	Air	Sunlight
A	5 ml	✓	✓
B	10 ml	✓	✓
C	5 ml	✓	X
D	15 ml	X	✓

Which containers should she use if she wants to find out whether the amount of water will affect the growth of seeds?

- (1) Containers A and B
 - (2) Containers A and C
 - (3) Containers B and C
 - (4) Containers B and D
10. The diagram below shows the life cycle of an animal.

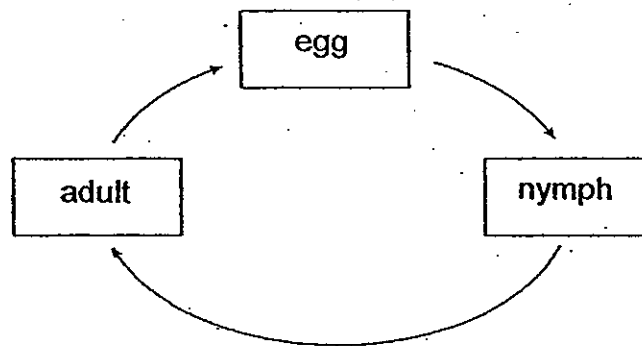

Which animal is most likely to have a life cycle as shown above?

- (1) beetle
- (2) chicken
- (3) butterfly
- (4) cockroach

11. Nathan can easily scratch a wooden stick with an iron nail.

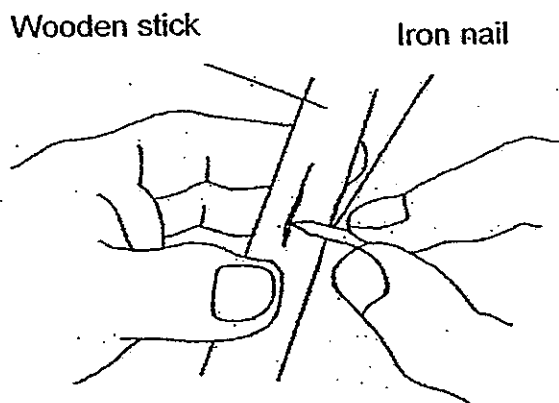

This shows that the iron nail is _____ than the wooden stick.

- (1) harder
- (2) heavier
- (3) stronger
- (4) more flexible

12. Study the classification table below. It shows how some objects are grouped according to what material they are made from.

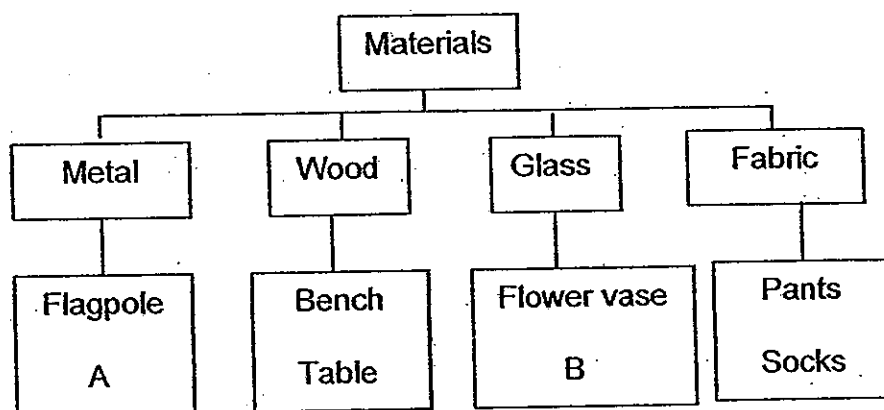

Based on the above classification, what are objects A and B most likely to be?

	A	B
(1)	Cup	Eraser
(2)	Window grill	Window pane
(3)	Chair	Shirt
(4)	Iron rod	Mirror

13. Mr Lim sets up an experiment as shown below to find out the strength of different types of paper.

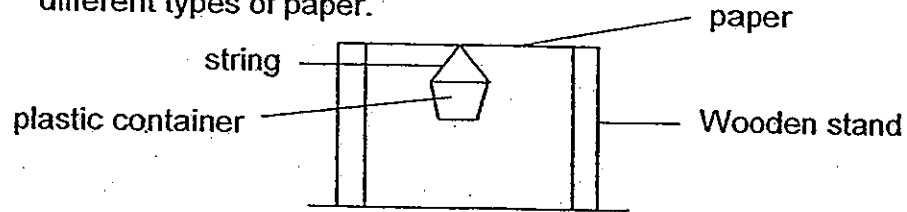

The number of coins the plastic container could hold before the paper tore was recorded in the table below.

Type of paper	Number of coins
Tissue paper	1
Art paper	10
Newspaper	4
Waxed paper	8

Based on the above results, which type of paper is the strongest?

- (1) Art paper
- (2) Newspaper
- (3) Tissue paper
- (4) Waxed paper

14. William wanted to compare the hardness of four objects, A, B, C and D. He tested them by scratching them with rulers of different materials. After the experiment, he concluded that object B is the hardest, followed by A, C and D. Which one of the following is the most likely observation that he had made?

(1)				(2)			
Objects	The tick (✓) indicates the presence of scratch marks made by the rulers.			Objects	The tick (✓) indicates the presence of scratch marks made by the rulers.		
	Plastic ruler	Wooden ruler	Metal ruler		Plastic ruler	Wooden ruler	Metal ruler
A		✓	✓	A		✓	✓
B	✓	✓	✓	B	✓	✓	✓
C			✓	C			✓
D				D			✓

(3)				(4)			
Objects	The tick (✓) indicates the presence of scratch marks made by the rulers.			Objects	The tick (✓) indicates the presence of scratch marks made by the rulers.		
	Plastic ruler	Wooden ruler	Metal ruler		Plastic ruler	Wooden ruler	Metal ruler
A			✓	A			✓
B				B		✓	✓
C		✓	✓	C	✓	✓	✓
D	✓	✓	✓	D	✓	✓	✓

15. In which of the following will two of the magnets push each other away?

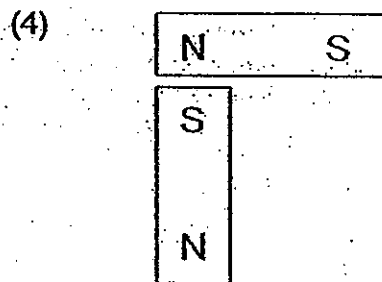
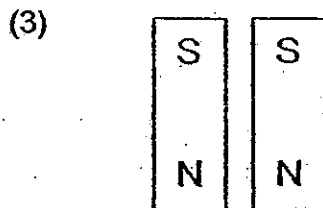
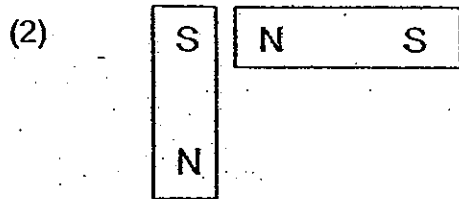
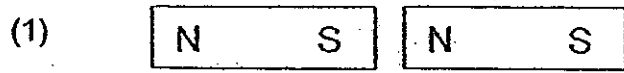

16. Vivian conducted an experiment as shown below. She lowered the bar magnet into a tray of staples and recorded the number of staples attracted to the magnet at different positions, W, X, Y and Z.

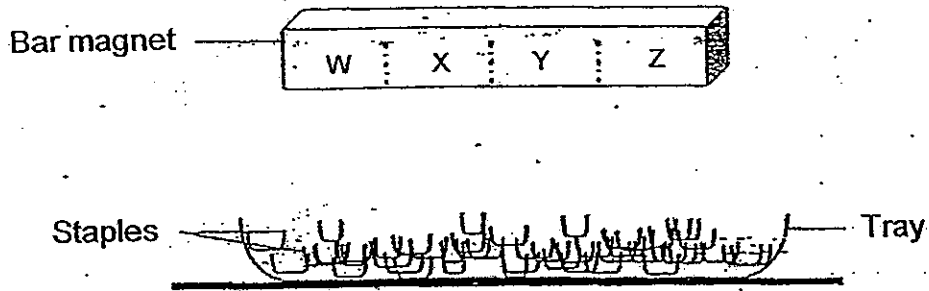

Her most likely aim was to find out whether the _____.

- (1) type of magnet affects the number of staples attracted
- (2) number of staples affects the magnetism of the bar magnet
- (3) parts on a magnet affects the number of staples it can attract
- (4) distance between the magnet and staples affects the number of staples the bar magnet can attract

17. A compass is brought near a freely-moving magnet. The diagram below shows the magnet after it has come to rest. Which of the following diagrams best represents the compass?

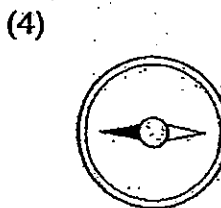
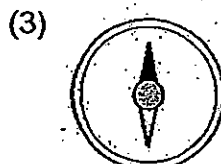
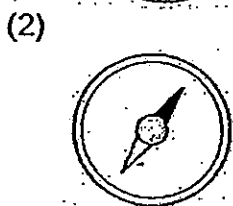
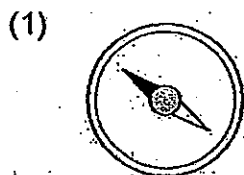
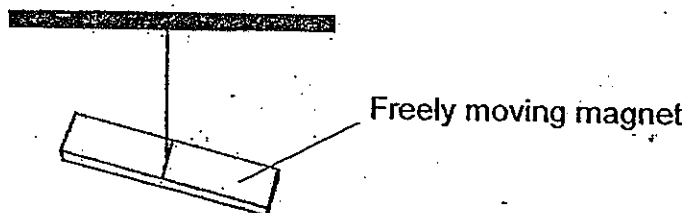
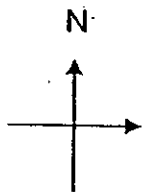

18. Four bar magnets with their ends marked A to ~~H~~^H can be arranged in the manner shown below.

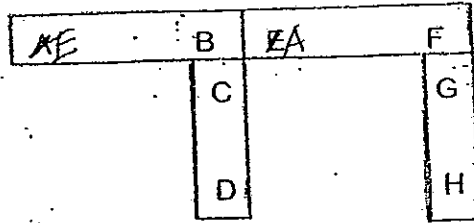

Which one of the following diagrams shows a possible arrangement of two of the magnets?

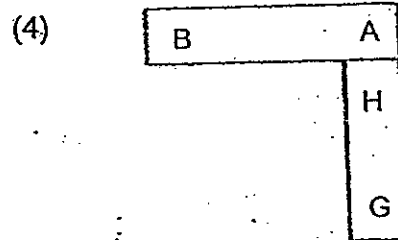
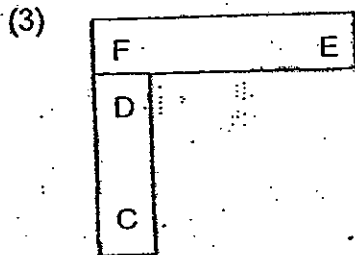
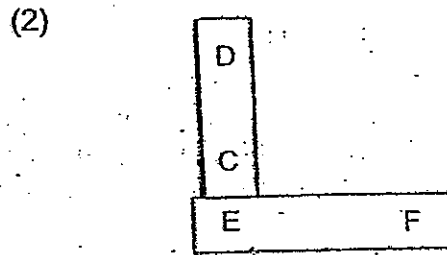
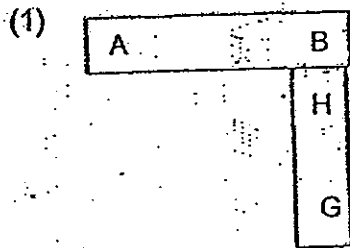

19. Study the diagrams below carefully.
Three objects were placed on a lever balance to compare their masses

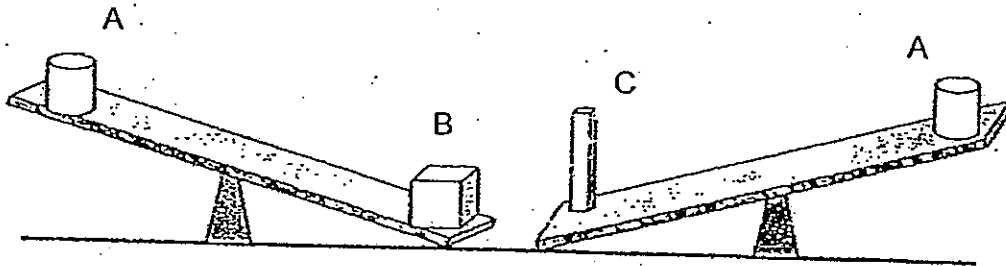

Based on the diagram above, which one of the following statements is true?

- (1) Object A has the greatest mass.
 - (2) Object C has the greatest mass.
 - (3) Objects B and C have the same mass.
 - (4) It is not possible to tell which object has the greatest mass.
20. Observe and compare the following syringes.
-

Which of the two plungers cannot be pushed inwards the furthest?

- (1) P and Q
- (2) Q and R
- (3) R and S
- (4) S and Q

21. Matter is anything that has mass and occupies space.
Which one of the following is not a matter?

- (1) air
- (2) soil
- (3) water
- (4) shadow

22. Study the diagram below carefully.

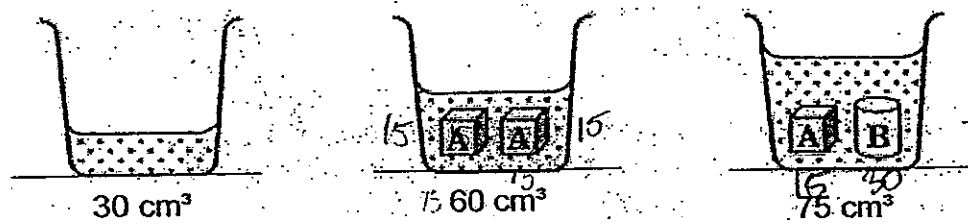

Which one of the following is the correct volume of object B?

- (1) 15 cm³
- (2) 20 cm³
- (3) 25 cm³
- (4) 30 cm³

23. Peter shone a torch on a ball to cast a shadow on the wall as shown in the diagram below.

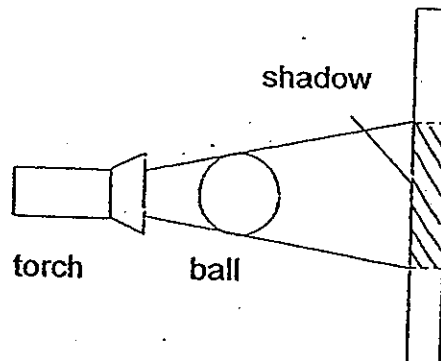

The torch was placed at four different positions, A, B, C and D. The following table shows the diameter of the shadows produced at each position.

Position	Diameter of shadow / cm
A	4
B	9
C	6
D	11

At which position, A, B, C or D, was the torch nearest to the ball?

- (1) A
- (2) B
- (3) C
- (4) D

24. The diagram below shows the shadow of an object formed on a screen when a torch light is shone at it.

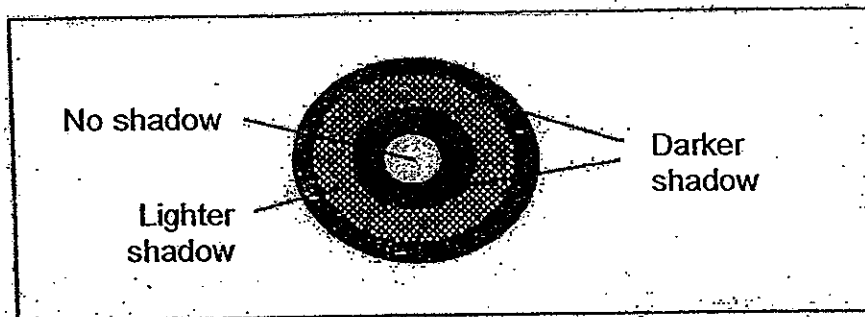

Which one of the following correctly shows the materials that make up the object?

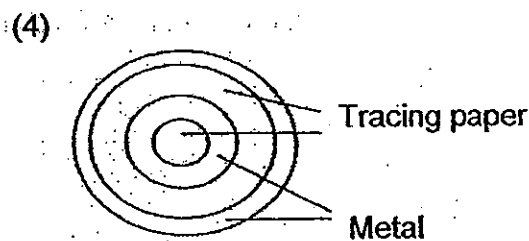
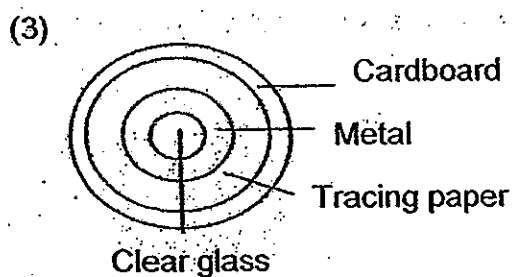
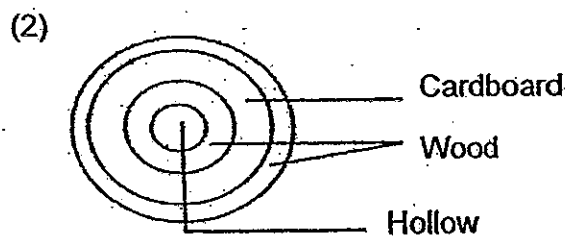
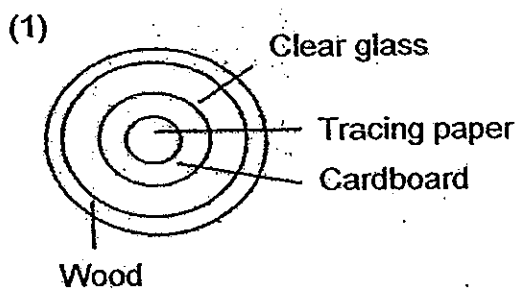

25. Two pieces of cardboard, a circle and a square are pasted one on top of the other.

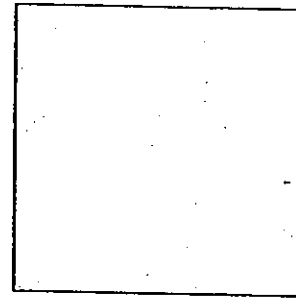
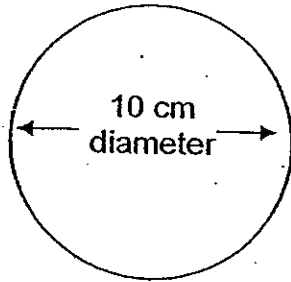

They are then placed between a torch and a screen as shown below. The diagrams are not drawn to scale.

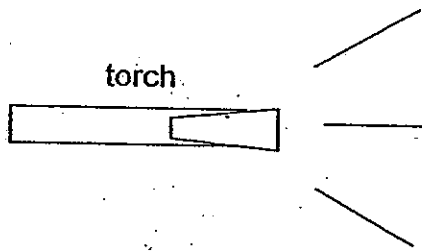

Which one of the following shadows is most likely to be formed?

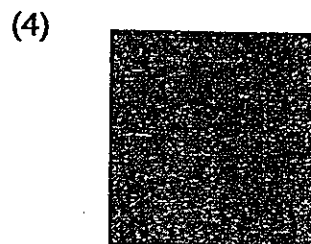
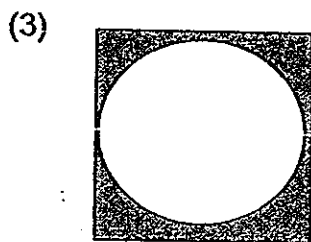
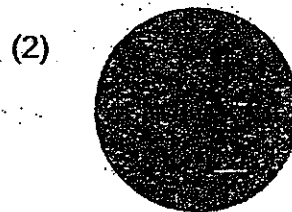
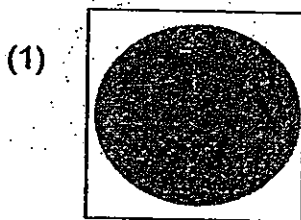

26. Louis wants to carry out an experiment to find out how different types of liquids affect the amount of light passing through it. He sets up the experiment as shown in the diagram below.

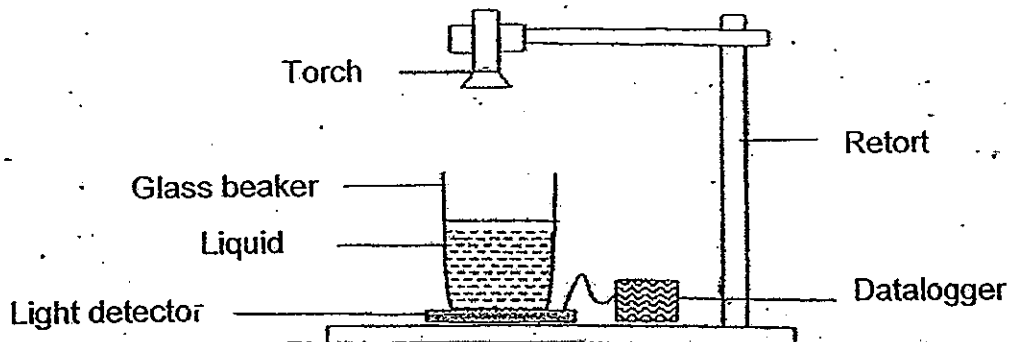

Which one of the following variables was changed in this experiment?

- (1) Type of liquid
 - (2) Intensity of light
 - (3) Type of glass beaker
 - (4) Distance of torch from the surface of the liquid
27. Study the diagram below carefully.

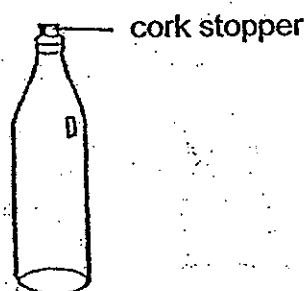

When an empty bottle is put near a fire, the cork stopper pops out because _____.

- (1) the air in the bottle warms up and expands
- (2) the air in the bottle cools down and contracts
- (3) the glass of the bottle warms up and expands
- (4) the glass of the bottle cools down and contracts

28. Abby placed a cube of ice into a glass of hot water.

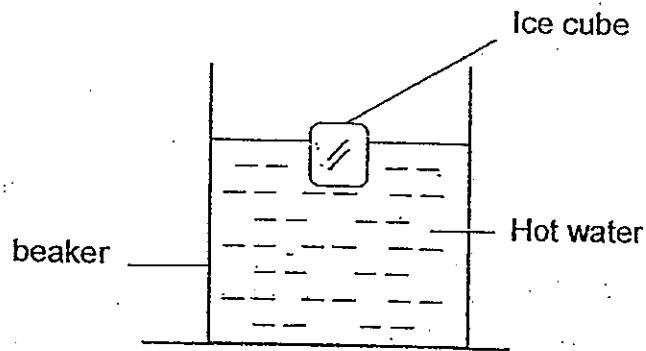

Which one of the following statements is correct?

- (1) The ice cube loses heat to hot water.
- (2) The ice cube does not lose or gain heat.
- (3) The hot water loses heat to the ice cube.
- (4) The hot water gains heat from the ice cube.

29. Meiling set up an experiment as shown in the diagram below to study the expansion of water.

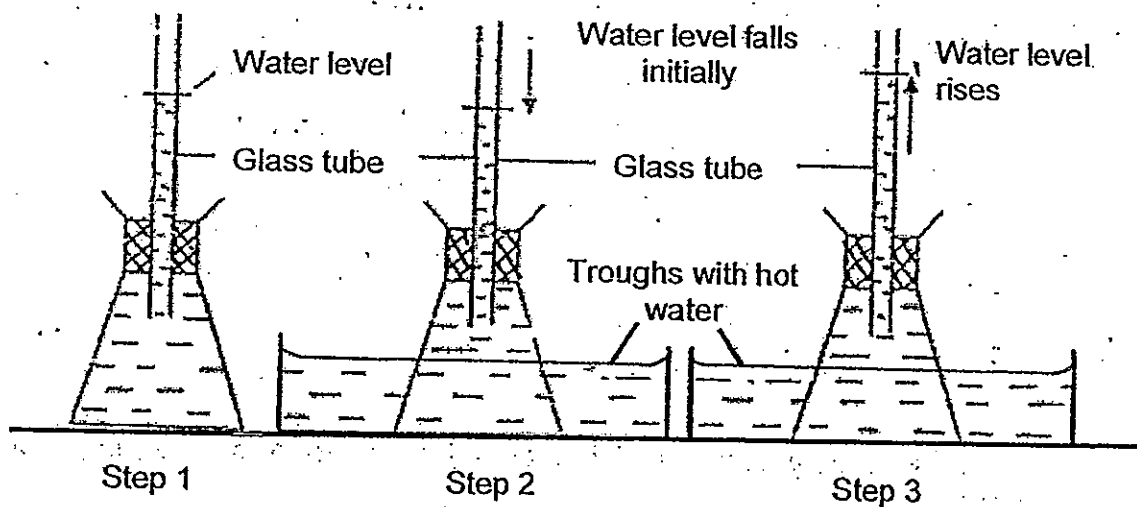

She observes that when the glass flask is put in a trough of hot water, the water level drops first before rising. This is because _____.

- (1) water contracts before expanding
- (2) some water in the glass tube evaporates
- (3) the glass flask expands before the water expands
- (4) some water from the glass flask leaks into the trough

30. Five similar rods, D, E, F, G and H, made of different materials are heated separately in the experiment as shown below.

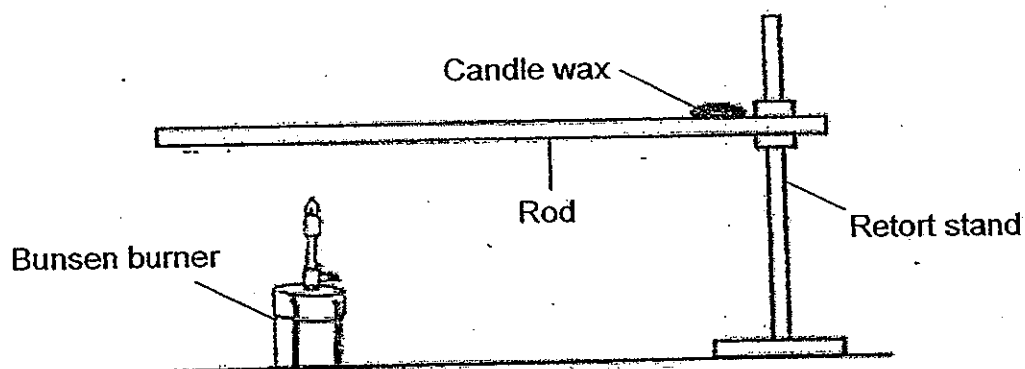

The time taken for the candle wax to melt completely is recorded as shown in the table below.

Rod	Time taken / s
D	57
E	74
F	31
G	46
H	28

Which one of the following shows the arrangement of the rods, according to how well they conduct heat, starting with the one that conducts heat the slowest?

- (1) H, F, E, D and G
- (2) E, G, D, F and H
- (3) H, G, F, E and D
- (4) E, D, G, F and H

- END OF SECTION A -



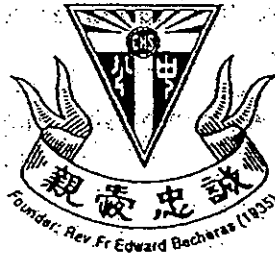

**CATHOLIC HIGH SCHOOL
PRIMARY 4
SEMESTRAL ASSESSMENT 2, 2010**

SCIENCE

Name: _____

Class : Primary 4 _____

Date : 28 October 2010

BOOKLET B

14 Questions
40 Marks

Total Time for Booklets A & B: 1 hour 30 minutes

Instructions to Candidates

Follow all instructions carefully.
Answer all questions.

Parent's Signature: _____

Date: _____

Score	
Section A	60
Section B	40
Total	100

Section B: Open-Ended Questions (40 marks)

Read the following questions carefully and write your answers in the space provided. The maximum marks that can be awarded is shown at the end of each question or part-question.

31. Deon observed and grouped some living things as shown in the table below.

G	H
snail grasshopper	tree grass

What are the suitable headings for G and H?

Group G: _____ [1]

Group H: _____ [1]

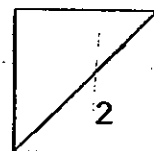

32. Gerard sets up an experiment using a balsam plant as shown in the set-up below.

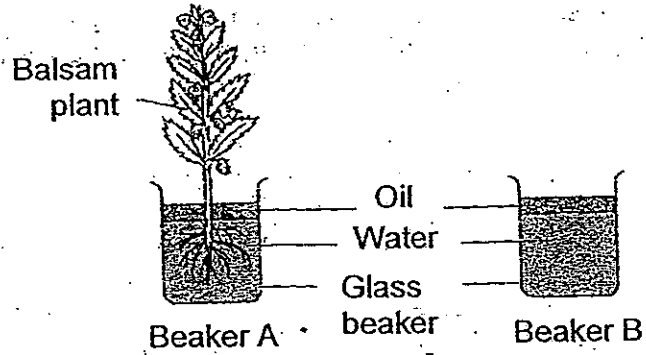

(a) What was the likely aim of the experiment? [1]

(b) Why was beaker B included in the experiment? [1]

(c) Draw in the new water and oil level in Beaker A after 2 weeks. [1]

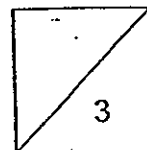
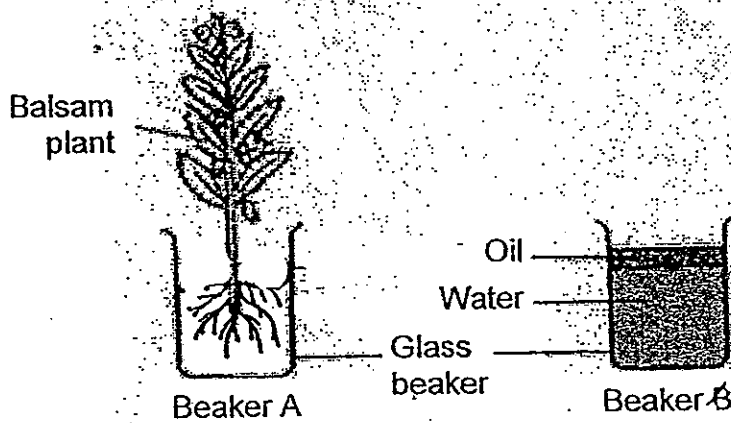

- (d) Gerard read an article about a new kind of balsam plant that takes up four times as much water as the balsam plant he used in his experiment.

If he sets up a new experiment using the new Balsam plant and if the claim in the article is true, explain what Gerard would observe.

[1]

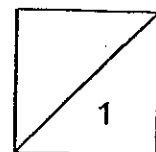

33. Scientists recently discovered a new species of animal and wanted to find out more about its digestive system. Four of the animals were fed, each with one type of food, W, X, Y and Z.

Different parts of the animals' digestive systems, A, B, C and D, were checked to see if the food were digested. The results were plotted in the graph below.

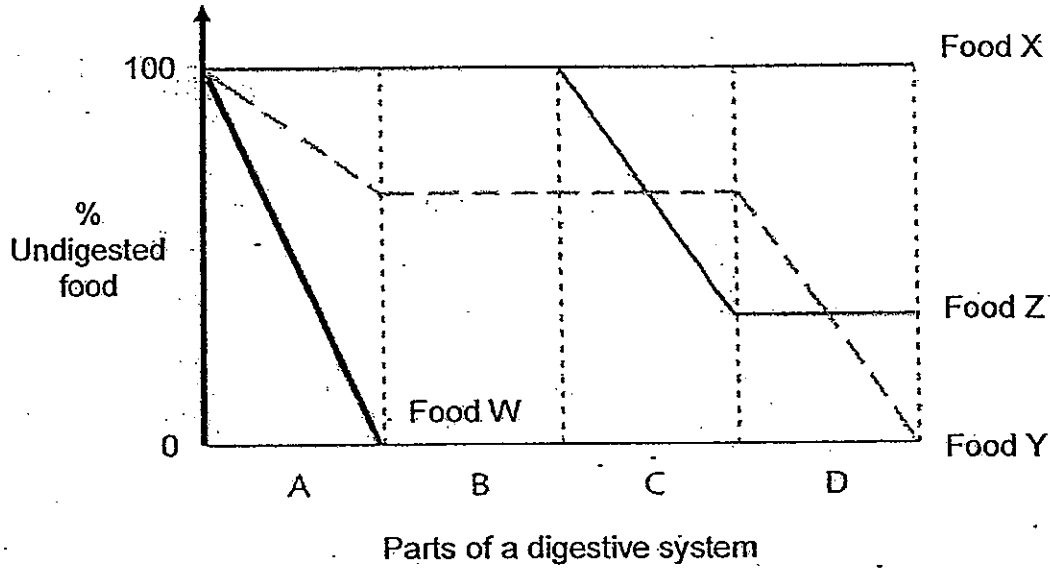

- (a) Which part of the animal's digestive system did digestion of Food Z begin? [1]

- (b) Suggest one improvement to the experiment so that the results obtained would be reliable. [1]

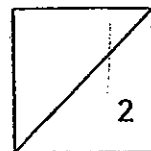

34. The diagram below shows two plants.

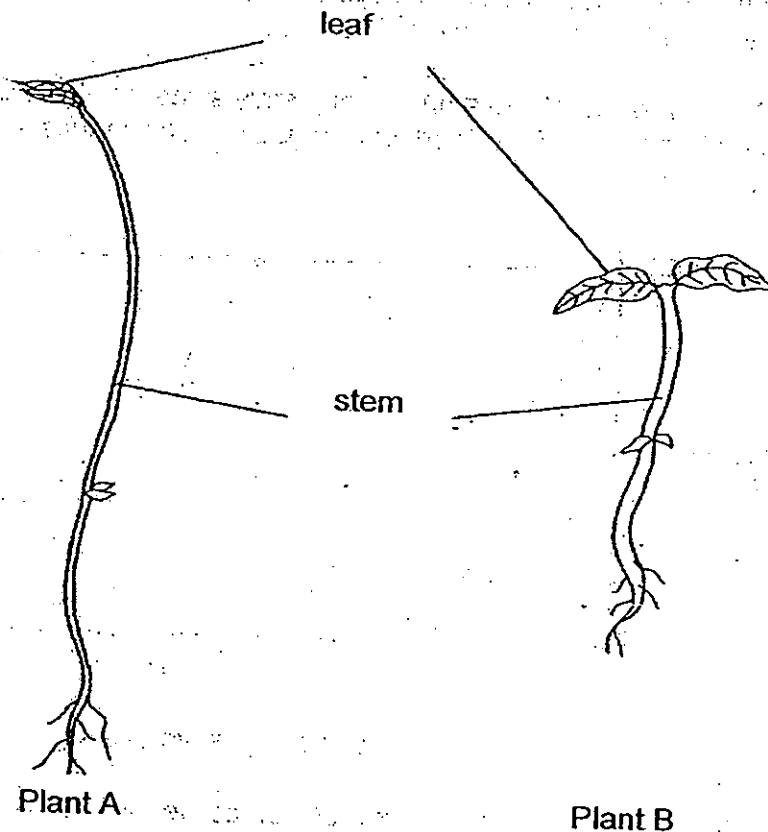

(a) What is the difference between the stem of Plant A and the stem of Plant B? [1]

(b) The leaves help both plants make _____ in the light. [1]

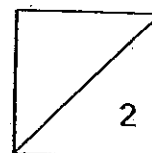

35. Daisy sets up an experiment as shown below.

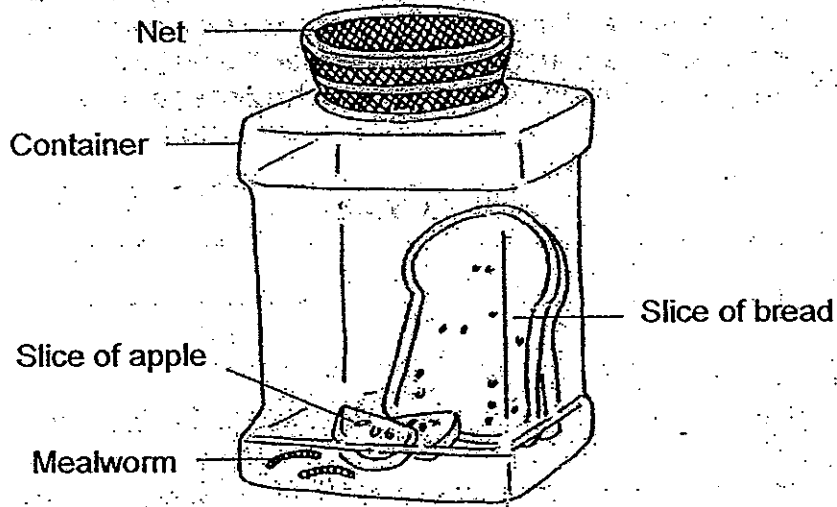

Daisy keeps the container in a warm place away from sunlight. She observes the mealworms regularly. After a few days, Daisy finds pieces of skin in the container. A few days later, she sees new pieces of skin in the container. This happens one more time. A few weeks later, the mealworms disappear and she sees beetles in the container.

(a) Why does Daisy put bread and apple slices in the container? [1]

(b) Where do the pieces of skin come from? [1]

(c) A net, instead of a metal or plastic lid, is used to cover the container. Why? [1]

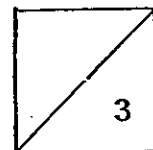

36. John wanted to find out which type of cloth absorbs the most amount of water. He carried out the experiment with 4 types of cloth, A, B, C and D. He weighed a piece of the dry cloth. He then placed the cloth completely in the same amount of water. He took the wet cloth out of the pail and weighed it. The table below shows his observations.

Cloth	Weight of dry cloth / g	Weight of wet cloth / g
A	40	50
B	45	55
C	40	60
D	42	72

- (a) In order to have a fair test, which two variables does he need to keep the same? [1]

- (b) Based on John's results, which type of cloth is most suitable for wiping plates dry? Give a reason for your answer. [2]

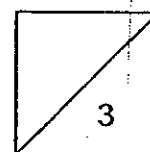

37. An iron nail can be magnetised by electricity when it is placed in a coil of wire. Kim wanted to find out how the thickness of the wire coiled around the nail can affect the strength of the electromagnet. She prepared the set-up as shown below.

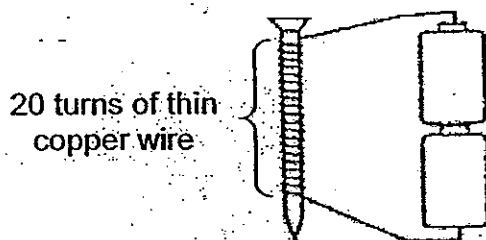

- (a) Using the North pole of a bar magnet, how can she prove that the nail is now an electromagnet? [1]

- (b) In order for her experiment to be a fair one, she decided to have another set-up. Which of the following variables should she change and which are the ones she should keep the same? Complete the table by putting a tick (✓) in the correct boxes. [2]

Variables	Keep the same	Change
Number of batteries		
Thickness of the wire used		
Material that the wire is made of		
Number of turns of wire around the nail		

- (c) Kim conducted another experiment. She coiled the wire around a glass rod and connected the wire to the ends of the two batteries. She brought the glass rod near some paperclip. Would the paperclip be attracted to the glass rod? Explain your answer. [2]

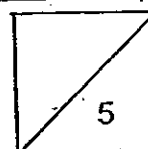

38. The diagram below shows a bottle of cooking oil.

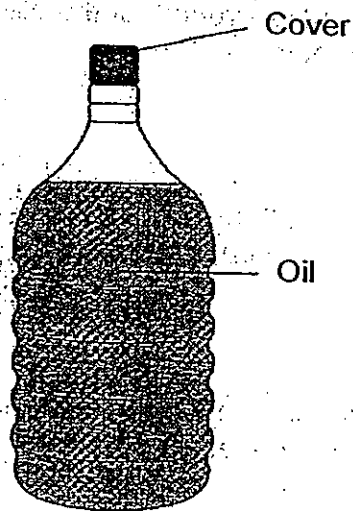

Complete the sentences to state if the parts are solid, liquid or gas.

(a) The cover is _____ [1]

(b) Oil is a _____ [1]

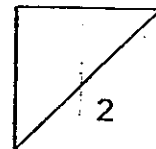

39. John poured 50ml of water into each measuring cylinder. He lowered an iron ball into cylinder A until it is fully submerged but not touching the bottom of the cylinder. He repeated the same action with a plastic ball. Both iron and plastic balls have the same shape and size.

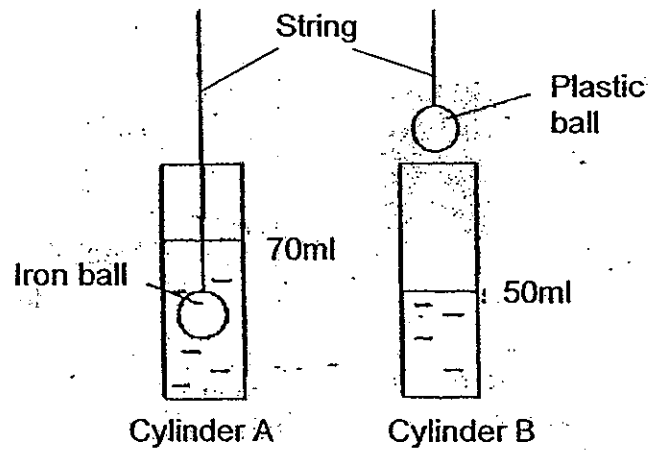

He recorded the water levels in the table below.

	Water level / ml	
	Before the ball was put inside	After the ball was put inside
Cylinder A	50	70
Cylinder B	50	(a)

- (a) What will be the water level in cylinder B after the ball was completely submerged? Complete the table above with your answer. [1]
- (b) He lowered the iron ball until it touched the bottom of Cylinder A. Would the water level be higher, lower or remain the same? [1]
-
- (c) Which property of the iron and plastic balls is tested in the above experiment? [1]

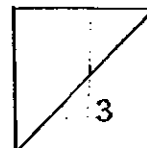

40. The experiment below was carried out in a dark room. Light from a bulb was shone on object X, an opaque cylinder. The shadow formed on the screen is shown.

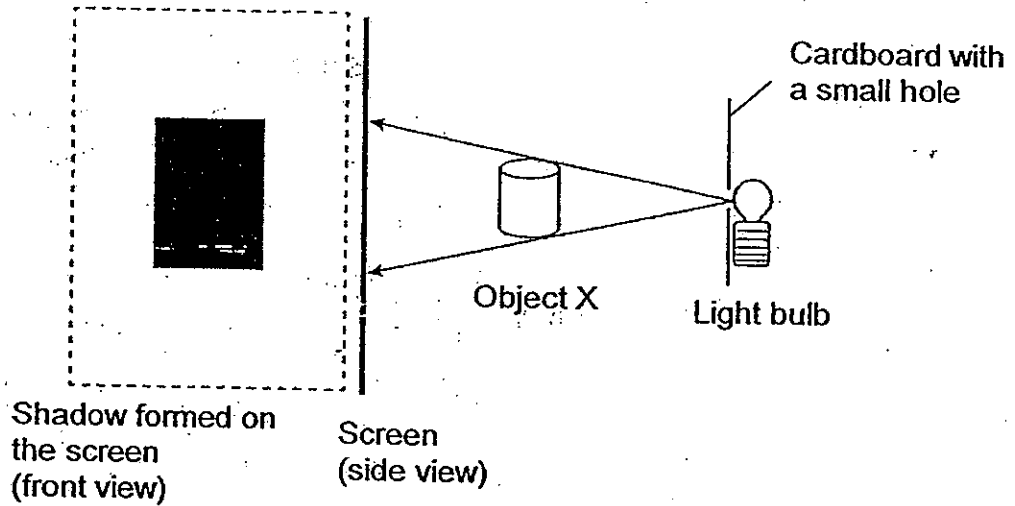

Object X is now replaced by object Y as shown below.

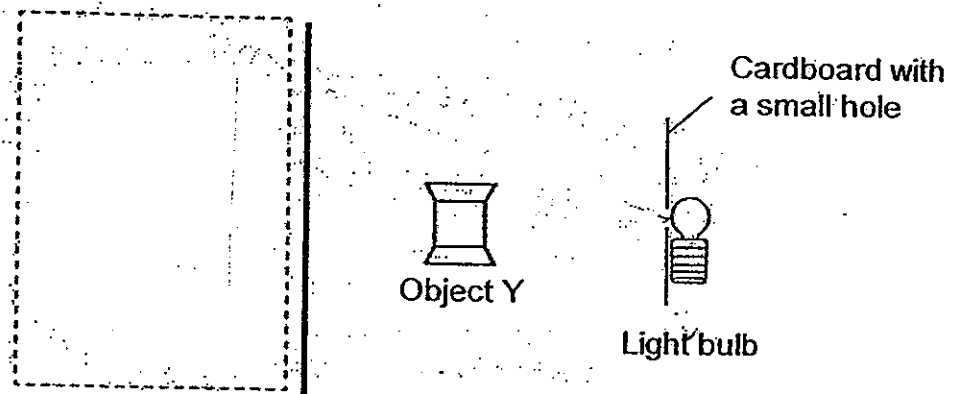

- (a) Draw the shadow formed on the screen. [1]
- (b) What is the property of light that results in the formation of a shadow? [1]

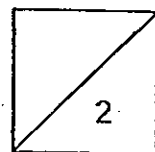

41. Joel placed his hand in front of a projector as shown in the following set-up.

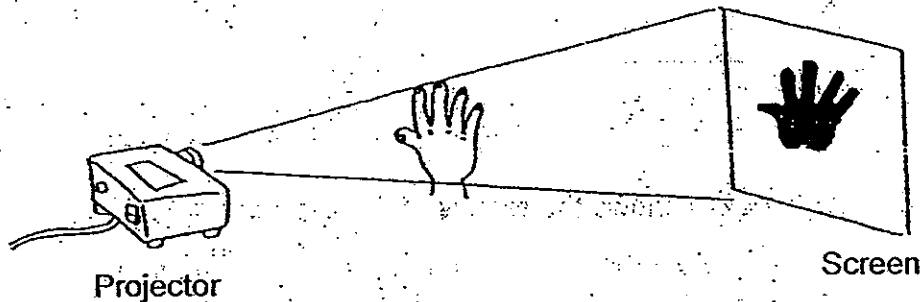

(a) Why was the shadow of Joel's hand cast on the screen? [1]

(b) What is the relationship between the size of the shadow and the distance between the object and light source? [1]

(c) Joel placed a blue plastic ball in front of the projector. What will be the colour of the shadow of the ball? [1]

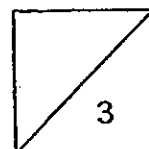

42. In an experiment, 20 ice-cubes were heated in each of the containers as shown below.

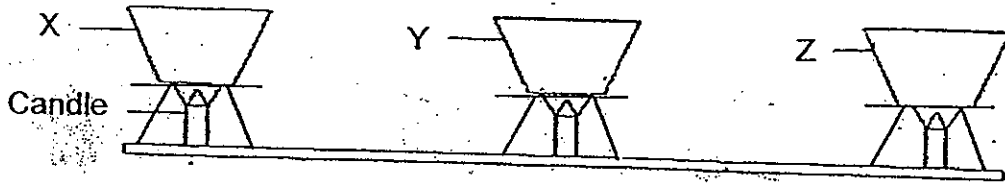

The table below shows the results of the experiment.

Material	Number of candles	Time taken for all the ice-cubes to melt completely
X	1	4 min 20 s
Y	1	2 min 45 s
Z	1	5 min 5 s

- (a) From the results above explain which material allowed the ice cubes to melt the fastest? [1]

- (b) Which material would you choose to make an ice-box that can prevent ice from melting? [1]

- (c) Explain your choice in part (b). [1]

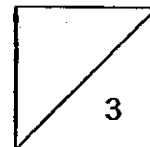

43. The diagram below shows an empty flask with a t-shape tube. There are two drops of ink in the tube. X represents the distance between the two drops of ink.

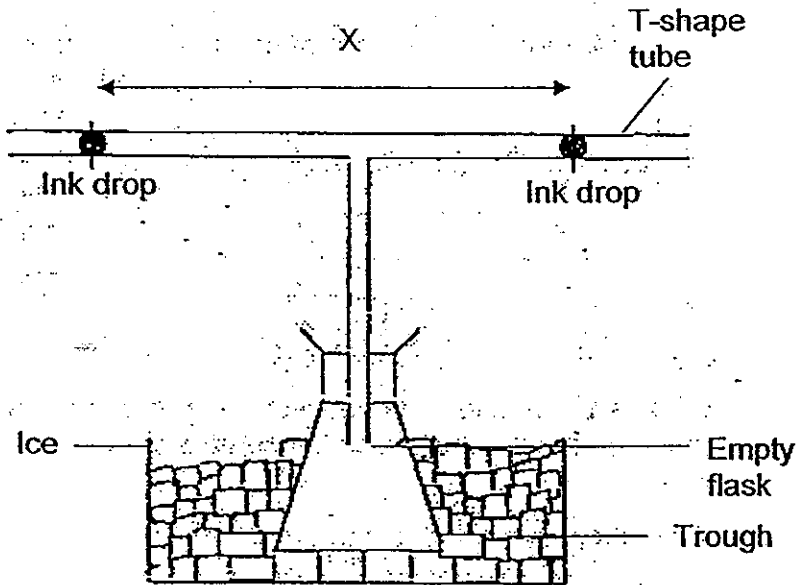

- (a) The empty flask was immersed into a trough filled with ice for 10 minutes. Explain the change in X. [1]

- (b) Give an explanation for your answer in part (a). [1]

- (c) What will happen to the distance between the ink drops when the empty flask is placed into a trough of hot water? [1]

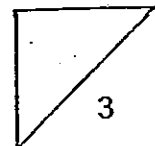

In another series of experiment, 20 ice cubes were completely melted in container X using different number of candles. The time taken for each of the experiment is provided in the table below.

Material	Number of candles	Time taken for all the ice-cubes to melt completely
X	1	4 min 20 s
X	2	3 min 25 s
X	3	2 min 37 s

- (d) What is the relationship between the number of candles and the time taken for the ice-cubes to melt completely? [1]

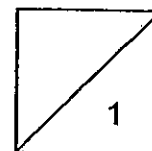

44. The diagram below shows a frying pan.

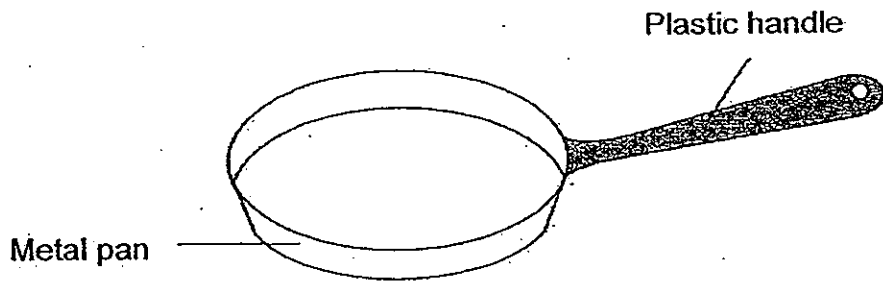

- (a) The handle is made of plastic because it is a _____ [1]
conductor of heat.
- (b) The pan is made of metal because metal is a _____ [1]
conductor of heat.

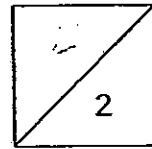

-END OF PAPER-

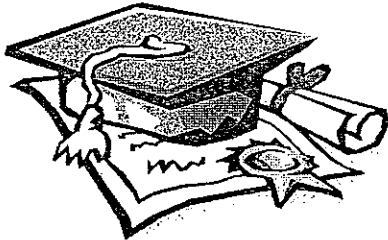

ANSWER SHEET

EXAM PAPER 2010

**SCHOOL : CATHOLIC HIGH PRIMARY
SUBJECT : PRIMARY 4 SCIENCE**

TERM : SA2

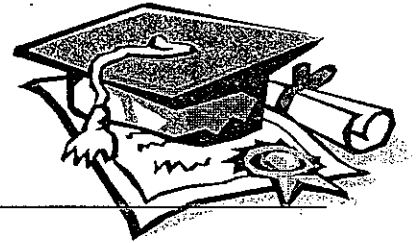

Q1	Q2	Q3	Q4	Q5	Q6	Q7	Q8	Q9	Q10	Q11	Q12	Q13	Q14	Q15	Q16	Q17
2	3	1	2	2	2	4	3	1	4	1	2	1	3	3	3	1

Q18	Q19	Q20	Q21	Q22	Q23	Q24	Q25	Q26	Q27	Q28	Q29	Q30
4	4	3	4	4	4	3	4	1	1	3	3	4

31)G: Animals H: Plants

32)a)It is to find out whether pants absorb water.

b)To show that any water loss is due only to the balsam plant.

c)

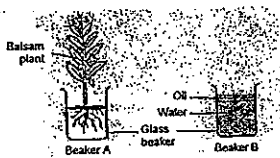

d)The water level in Beaker B would drop four times as much as the water level in Beaker A.

33)a)C.

b)Use the same type of food.

34)a)A is taller than B.

b)food.

35)a)The bread is food the mealworms and the slice of apple provides water for the mealworms.

b)From the mealworm.

c)The not allows air to enter the container so that the mealworm can breathe.

36)a)The time taken to soak the cloth and the size of cloth used.

b)Cloth D is most suitable. It is the most absorbent.

37)a)Bring the North pole of the bar magnet to each end of the nail. One end should attract while the other repel the magnet.

b)Keep the same

Change

Keep the same

Keep the same

c)No, glass is a non-magnetic material, so it cannot be magnetised.

38)a)solid.

b)liquid.

39)a)70

b)The water level would remain the same.

c)Solid has a definite volume.

40)a)

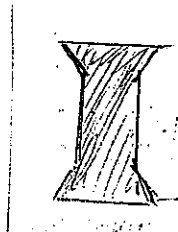

b)Light travels in a straight line.

41)a)Joel's hand is opaque.

b)The shorter the distance between the object and the light source, the bigger the shadow.

c)Black.

42)a)Material Y. Because the time taken for all the ice-cubes to melt completely is the shortest.

b)Material Z.

c)Material Z is the poorest conductor of heat.

d)The greater the number of candles, the shorter the time taken for the ice-cubes to melt completely.

43)a)X become shorter as the ink drops moved towards each other.

b)When the flask is immersed into a trough filled with ice, the air in the empty flask contracts when cooled.

c)The distance between the ink drops will increase.

44)a)bad

b)good