

SINGAPORE CHINESE GIRLS' SCHOOL  
SECOND SEMESTRAL ASSESSMENT 2011  
PRIMARY 4  
SCIENCE

Name: \_\_\_\_\_ ( )

Class: 4 SY / C / G / SE ' P

Part I ( 30 x 2 marks)

For each question from 1 to 30, four options are given. One of them is the correct answer. Make your choice (1, 2, 3 or 4). Shade the correct oval (1, 2, 3 or 4) on the Optical Answer Sheet.

1. Which one of the animals shown below is **NOT** an insect?

(1)



(3)



(2)



(4)



2. Which of the following observations show that a guppy is a living thing?

- A: It can die.
- B: It has fins.
- C: It feeds on fish-food.
- D: It is found in the water.

- (1) A and B only
- (2) A and C only

- (3) B and C only
- (4) B and D only

3. Which one of the following objects can be bent easily without breaking?

(1) A glass cup



(3) A cotton towel

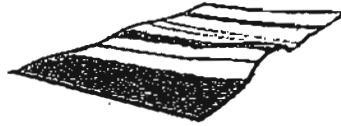

(2) A wooden ruler

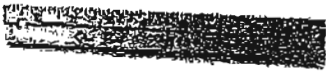

(4) A plastic fork



4. Sherman wanted to classify the Rose plant and Maiden's Hair Fern into two groups. Which of the following group(s) is/are **INCORRECT**?

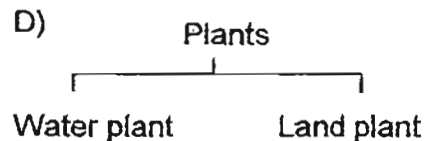
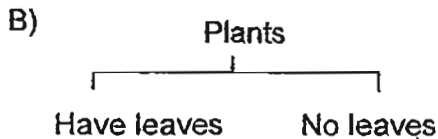
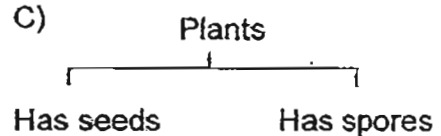
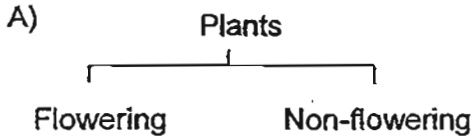

(1) A and B only

(3) B and D only

(2) A and C only

(4) C and D only

5. Which one of the following is the function of a leaf on a plant?

(1) makes food

(2) takes in water

(3) holds plant upright

(4) takes in mineral salts

6. Muthu accidentally broke part of the roots of a green bean plant while planting it in a pot. What is likely to happen to the plant after 3 days?



- (1) The plant will wither and die.  
(2) The plant will continue to grow.  
(3) The leaves of the plant will all fall off.  
(4) The leaves of the plant will turn yellow.
7. What is the main function of the large intestine?
- (1) It removes digested food from the body.  
(2) It removes undigested food out of the body.  
(3) It allows digested food to be passed into the blood.  
(4) It allows water to be removed from the undigested food.
8. Kyle wrote the following descriptions about an object.
- It is oval and soft.
  - It is bright blue.
  - It bounces and makes a sound.

How many senses did he use in order to come up with the descriptions?

- (1) five  
(2) two  
(3) three  
(4) four
9. Our body is made up of the following systems:
- A: Circulatory System  
B: Skeletal System  
C: Muscular System  
D: Respiratory System
- Which of the above systems are involved when you are chasing your friend in a game of catch?
- (1) A and D only  
(2) B and C only  
(3) B, C and D only  
(4) A, B, C and D

10. Britney poured 200ml of water into 2 similar beakers A and B. She then placed a plant in beaker B and placed both beakers on a table near the window.

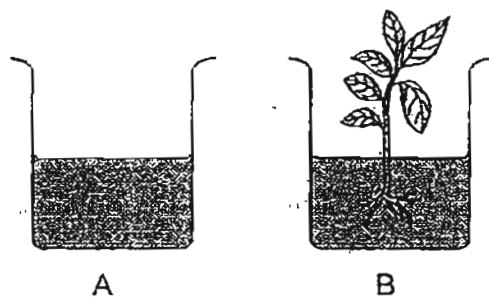

Britney took the plant out from beaker B after 2 days. Which of the following diagrams show the most likely amount of water left in the 2 beakers?

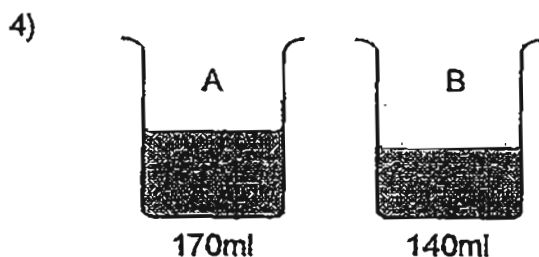
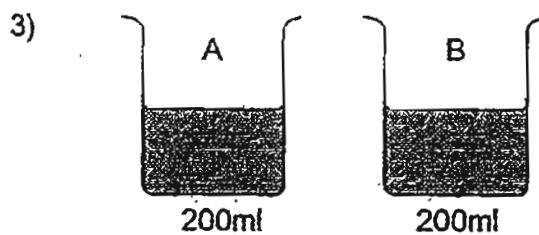
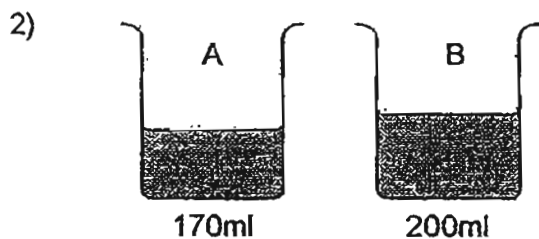
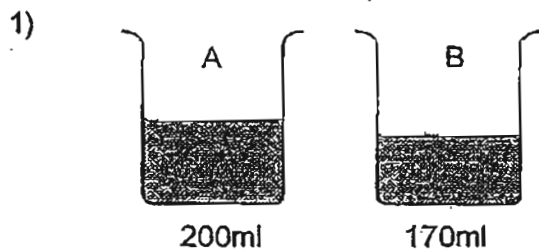

11. In which one of the following will the two magnets push each other away?

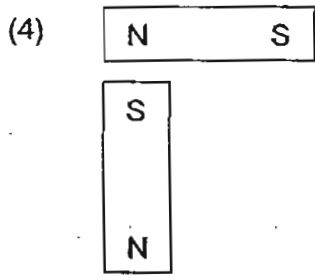
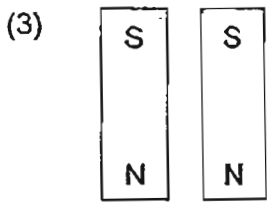
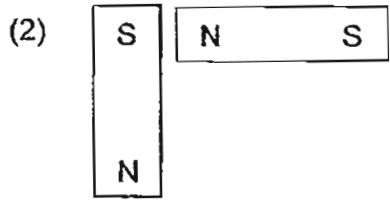

12. Which one of the following can be attracted by a magnet?

- (1) steel ball
- (2) rubber ball

- (3) plastic ball
- (4) wooden ball

13. Lisa used 4 similar ring magnets P, Q, R and S and made 3 setups as shown in the diagram below.

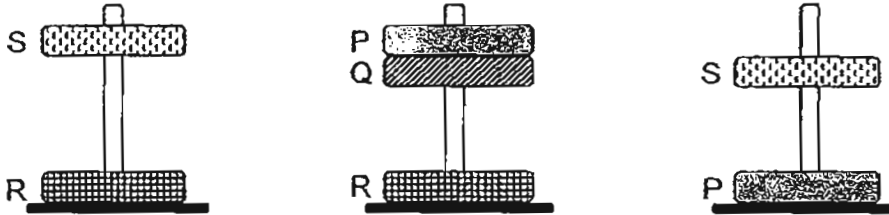

Based on her observations, what conclusions can she make?

- A: All the like poles of the magnets are facing each other.  
 B: Magnet P has a stronger magnetic force than Magnet Q.  
 C: Magnet R has a stronger magnetic force than Magnet P.  
 D: The magnets 'floating' above each other are caused by the repulsion.

- (1) A and C only  
 (2) C and D only  
 (3) A, B and D only  
 (4) B, C and D only

14. Mary has 4 different magnets. She brought each magnet near 20 paper clips. She counted the number of paper clips attracted by each magnet and measured the distance between the magnet and the paper clips as shown below.

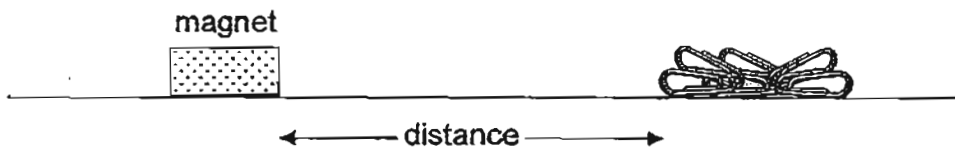

Type of Magnet	Number of paper clips	Distance (cm)
Bar	18	9
Ring	5	3
U-shape	10	5
Rod	18	7

Based on the table above, which magnet is the strongest?

- (1) Bar  
 (2) Ring  
 (3) U-shaped  
 (4) Rod

15. Joan wears a woollen jacket to keep herself warm during winter. The woollen jacket \_\_\_\_\_.

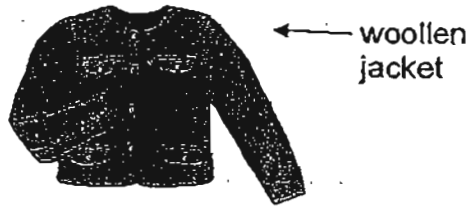

- (1) allows some heat to escape easily
- (2) prevents body heat from escaping
- (3) does not allow cold air to enter at all
- (4) takes in heat from the surrounding air

16. Wen Qiang conducted an experiment with 4 rods made of different materials. He wanted to find out which is a better conductor of heat. He attached 4 thumbtacks using wax to one end of each rod and heated the other end for 2 minutes. He repeated the experiment for the 4 rods.

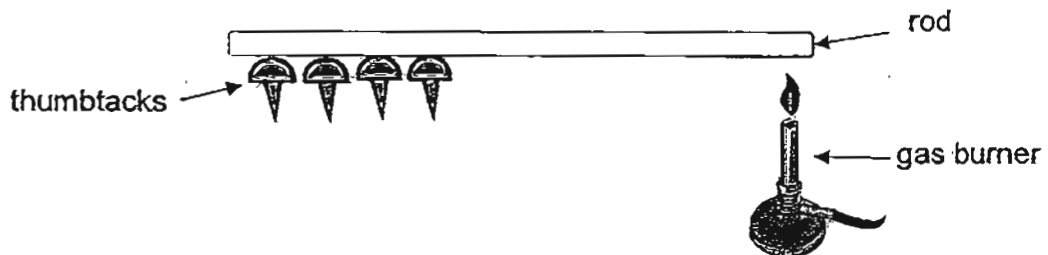

The table shows his findings.

	Rod P	Rod Q	Rod R	Rod S
Number of thumbtacks still stuck on the rod after 2 minutes	2	1	4	3

Put the rods in order from the **poorest** conductor of heat to the **best** conductor of heat.

- (1) Q – P – S – R
- (2) R – S – P – Q
- (3) P – Q – R – S
- (4) S – R – Q – P

17. The same amount of boiling water is poured into four similar cups made of different materials. Which cup of water will take the **shortest** time to cool?



(1) glass



(2) metal



(3) ceramic



(4) plastic

18. A beaker of hot water was placed in a bowl of ice cubes as shown below.

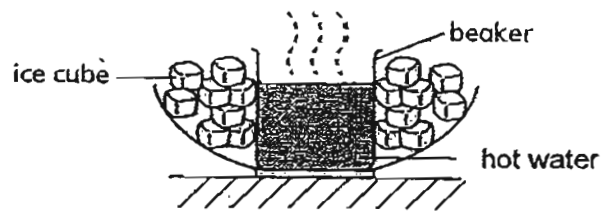

Which of the following statements are true about transfer of heat?

- A: The ice cube loses heat to the hot water and melts.  
B: The ice cube gains heat from the hot water and melts.  
C: The hot water loses heat to the ice cubes and cools down.  
D: The hot water gains heat from the ice cubes and cools down.
- (1) A and C only                      (3) B and C only  
(2) A and D only                      (4) B and D only
19. An iron weight was tied with a cotton string and hung from a piece of copper wire as shown below.

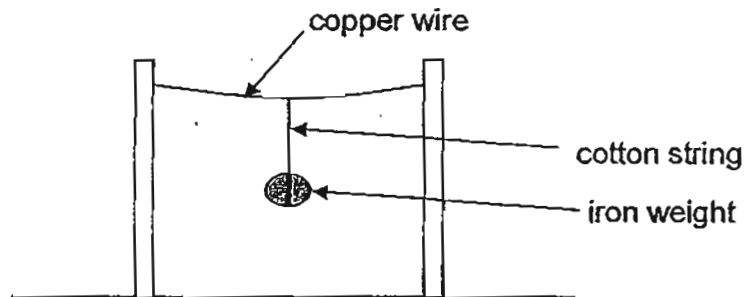

When the wire is heated, what will happen to the iron weight?

- (1) It will go lower as the copper wire expands.  
(2) It will go lower as the cotton string expands.  
(3) It will go up higher as the copper wire contracts.  
(4) It will remain in the original position as copper is a poor conductor of heat.



20. Look at the picture below.

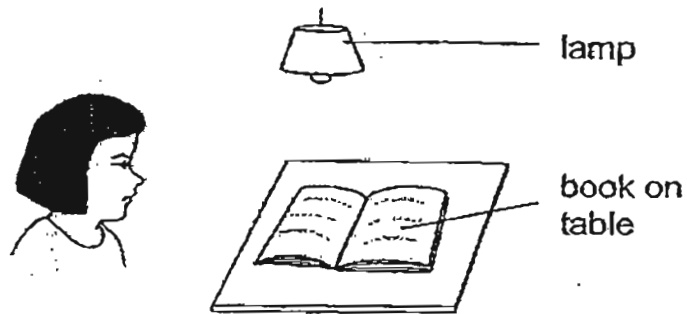

Which one of the following explains why Sally can see the book on the table?

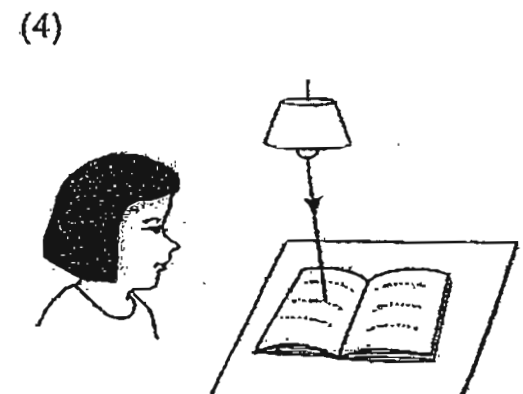
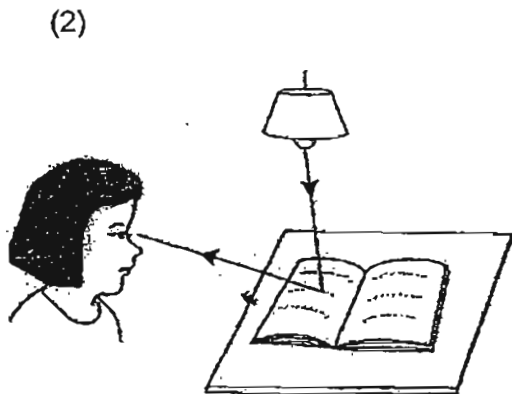
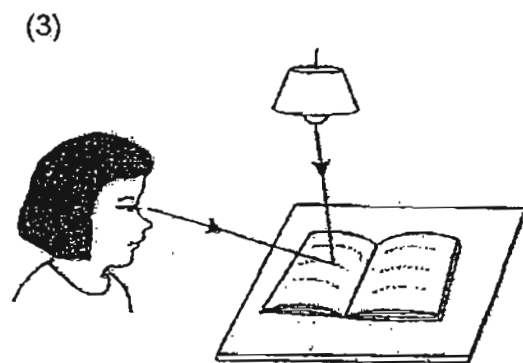
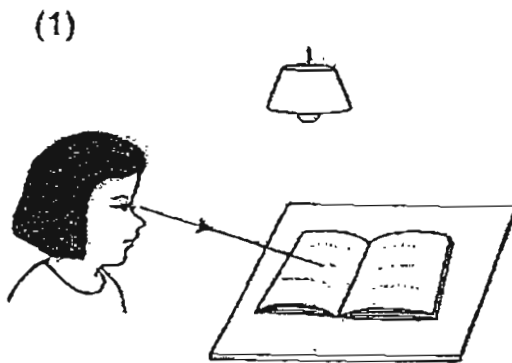

21. Which of the following shadows is **NOT** possible to form given that Object P is not moved and the light source can be moved.

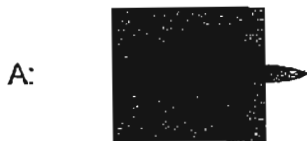

- (1) A only  
(2) B only

- (3) A and C only  
(4) B and D only

22. Beng wanted to find out how the length of a shadow cast on screen will be affected by moving the object to different positions, A, B and C.

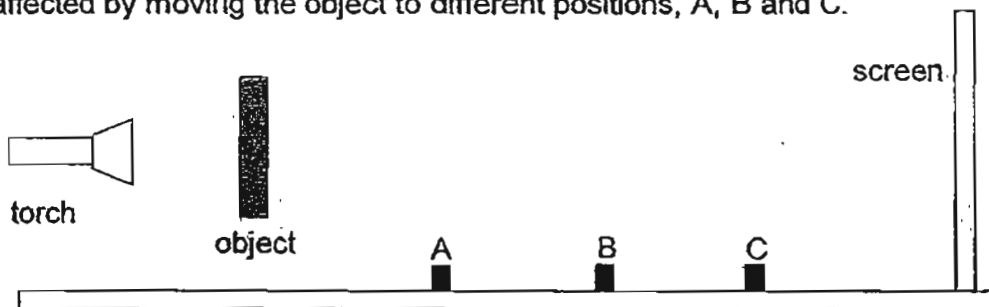

Which of the following variables must he keep the same to ensure a fair test?

- A: The position of the torch.  
 B: The position of the object.  
 C: The position of the screen.  
 D: The distance between the torch and the object.  
 E: The distance between the screen and the object.

- (1) A and C only  
(2) A, B and E only

- (3) A, C and D only  
(4) B, C, D and E only

23.

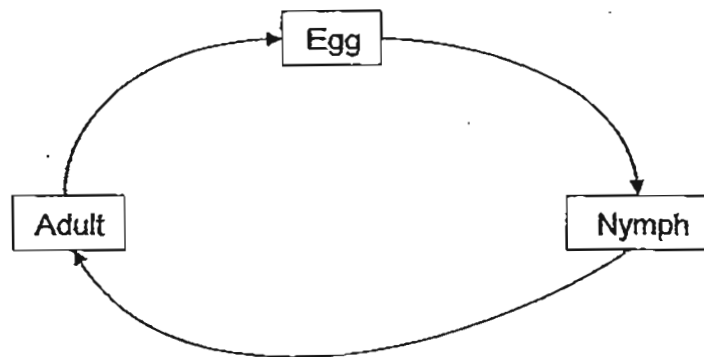

Which animal is likely to have the life cycle as shown above?

- (1) beetle
- (2) chicken
- (3) butterfly
- (4) cockroach

24. Peggy found two insects of different species. Peggy kept the insects in a glass bottle and covered it with wire gauze so that the insects would not escape. She fed them with leaves.

After a week, she found that Insect A had stopped moving and seemed to be covered in a brownish shell. Insect B however, looked just the same and there were pieces of dried skin in the bottle.

Based on the above description, what can Peggy conclude?

- (1) Insect B moulted, Insect A did not moult.
- (2) Insect A died because it did not move but Insect B was still alive.
- (3) Insect A has a 4-stage life cycle and Insect B has a 3-stage life cycle.
- (4) Insect A has a 3-stage life cycle and Insect B has a 4-stage life cycle.

25. Matter is anything that has mass and occupies space.

Which one of the following is **NOT** matter?

- (1) Air
- (2) Soil
- (3) Shadow
- (4) Water

26. Gopal pumped air into 2 footballs. The footballs when fully inflated each have a capacity of  $400\text{cm}^3$ . For football A, he pumped  $350\text{cm}^3$  into it and for football B, he pumped  $405\text{cm}^3$ . Which of the following statements is correct?



Ball A  
 $350\text{cm}^3$



Ball B  
 $405\text{cm}^3$

- (1) Ball A is heavier than Ball B.
  - (2) Ball B has  $405\text{cm}^3$  of air inside it.
  - (3) Both Ball A and Ball B has  $400\text{cm}^3$  of air inside it.
  - (4) Ball A and Ball B are of the same mass after the air was pumped in.
27. Josh filled 4 similar syringes with the same volume completely with air, water, cotton wool and plasticine. He covered the nozzle of the syringe with his finger to prevent the air inside from escaping. He exerted pressure on the plunger as far as it can move towards nozzle. Which of the following graphs correctly represent the syringe that contains the cotton wool?

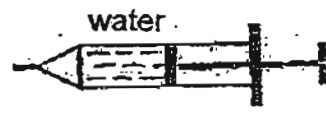
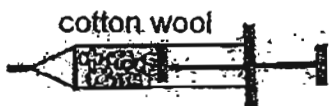

(1)

(3)

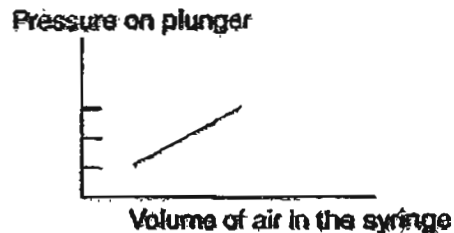
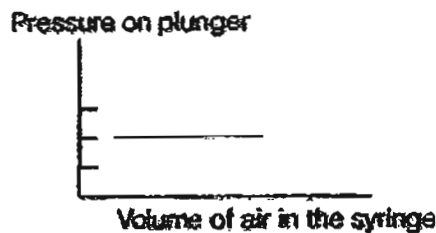

(2)

(4)

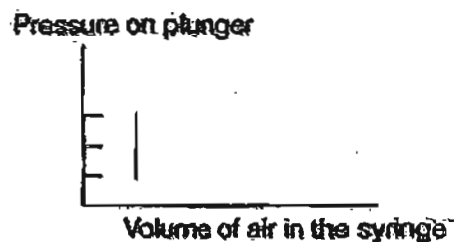
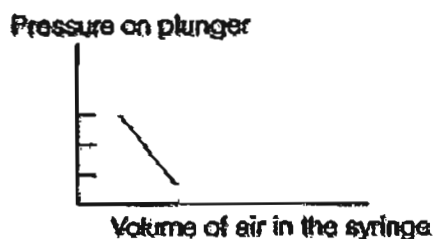

28. The diagram below shows four similar containers, A, B, C and D, each containing 200 ml of water with different temperatures. The containers are placed in a room with a temperature of 25°C.

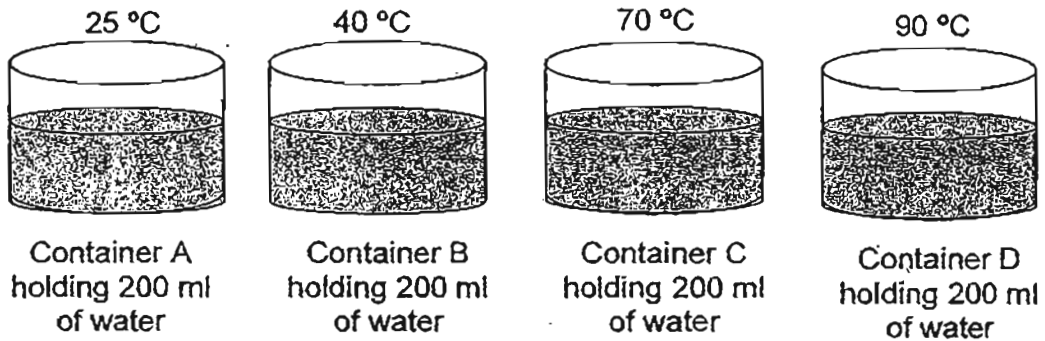

In which of the containers will the water evaporate the fastest?

- (1) Container A                                      (3) Container C  
 (2) Container B                                      (4) Container D

29. A beaker of ice was taken out from the freezer and the ice was left to melt. After 15 minutes, all the ice melted and the beaker of water was placed on a heater. The water started to boil after 20mins. Which one of the following graphs shows the change in the temperature of the water from the time it was taken out of the freezer to the time the water boiled?

(1) Temperature (°C)

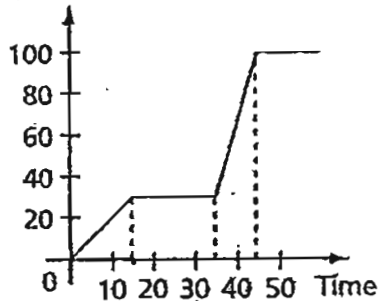

(3) Temperature (°C)

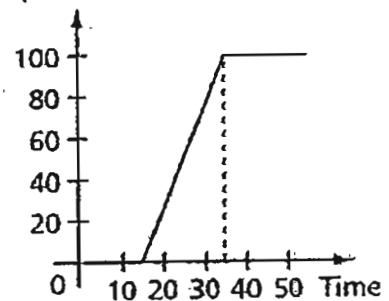

(2) Temperature (°C)

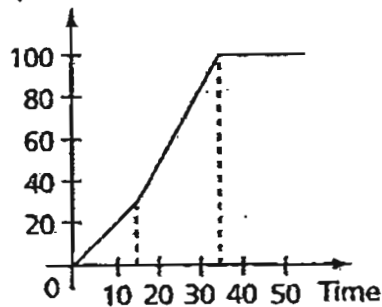

(4) Temperature (°C)

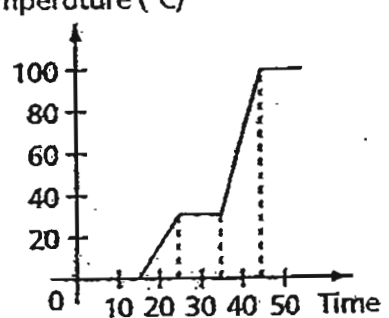

30. Two beakers containing the same number of ice cubes were placed on two heaters as shown below. The heaters were set at different temperatures.

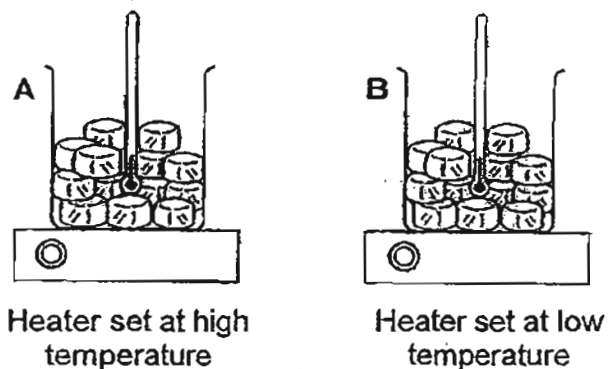

Which of the following statements correctly describe the changes in the beakers?

- A: The ice cubes in Beaker B will melt slower than that of Beaker A.
- B: The ice cubes in both beakers will take the same time to melt completely.
- C: The ice cubes in both beakers will remain at  $0^{\circ}\text{C}$  until they have completely melted.
- D: When all the ice cubes in Beaker A have melted completely, the water in it will reach boiling point first.

- (1) A and C only
- (2) B and D only

- (3) A, B and C only
- (4) A, C and D only

SINGAPORE CHINESE GIRLS' SCHOOL  
SECOND SEMESTRAL ASSESSMENT 2011  
PRIMARY 4  
SCIENCE

Name: \_\_\_\_\_ ( )

Date: \_\_\_\_\_

Class: Primary 4 SY/C/G/S&P

Components	Marks Obtained	Total Possible Marks
Part I		60
Part II		40
Total		100

Parent's Signature: \_\_\_\_\_

Part II ( 40 marks)

Answer all the following questions.

31.

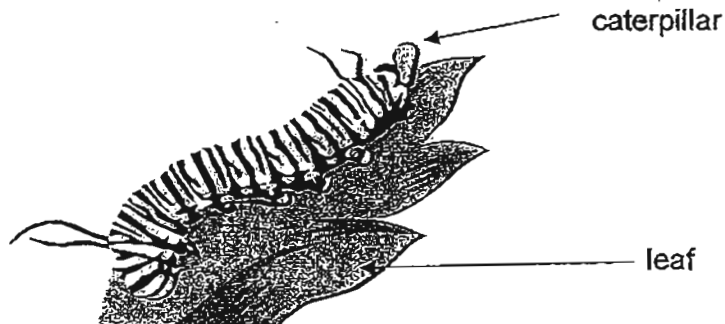

(a) The caterpillar needs food, water and \_\_\_\_\_ to stay alive.  
(1m)

(b) The caterpillar eats leaves and becomes longer and bigger after some time shows that it can \_\_\_\_\_. (1m)

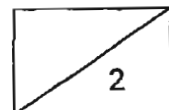

32. Mrs Tay wanted to buy some containers to store leftover food in the refrigerator. She has some requirements for the containers.

- It should not be easily breakable.
- The containers should not be heavy and bulky.
- The containers should be able to hold both wet and dry food.
- The containers would allow her to see what was in them without opening them.

Put a tick (✓) ONLY in the boxes beside the characteristics that the containers should have. (2m)

	Characteristics	(✓)
(b)	Strong	
(c)	Transparent	
(d)	Coloured	
(e)	Waterproof	
(f)	Elastic	
(g)	Light	

33. Choose the correct words from the box to answer the questions below.

gullet    large intestine    mouth    small intestine    stomach

In a human digestive system, name the part where

(a) digestion first takes place: \_\_\_\_\_ (1m)

(b) digestion is completed: \_\_\_\_\_ (1m)

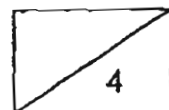



34. Stella ate a piece of bread for breakfast. She plotted a graph as shown below which showed the amount of food that had been digested as the bread moved through her digestive system.

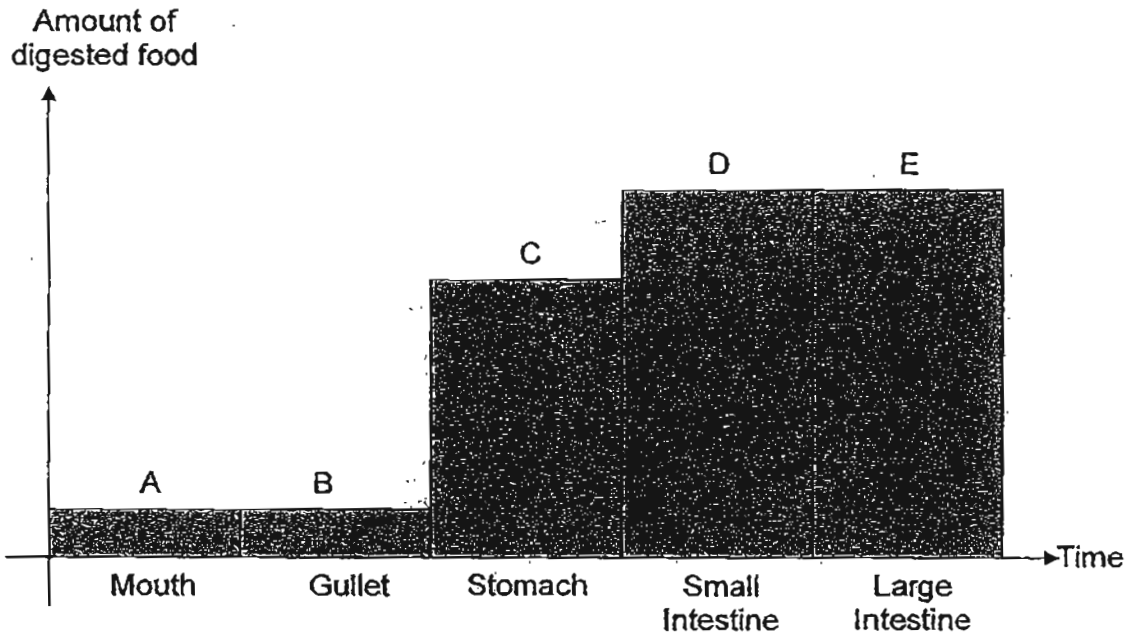

She then showed the graph to her teacher and he pointed out that there was a mistake in the graph.

Which part of the graph (A, B, C, D and E) is incorrectly drawn? Explain your answer. (2m)

---

---

---

---

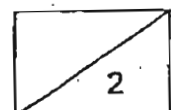

35. Martha bought a cleaning device designed to clean the outer surface of windows from the inside. The device uses two magnets as shown in the diagram below.

In order to use the cleaning device, Martha has to hold the handle of the cleaner that is on the inside of the window and slide it up and down. The two cleaning sponges will move together.

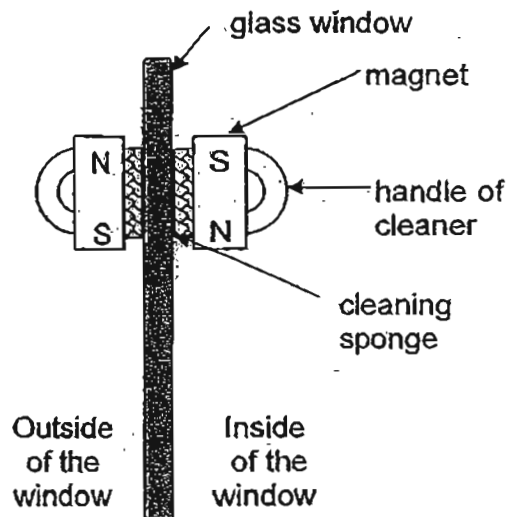

Which two properties of magnets are needed for this device to work? (2m)

a) \_\_\_\_\_

\_\_\_\_\_

b) \_\_\_\_\_

\_\_\_\_\_

c) After Martha had left the device for a week in the hot sun, she found that it could no longer work. Give a reason what could have happened. (1m)

\_\_\_\_\_

\_\_\_\_\_

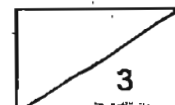

36. The diagram below shows a frying pan.

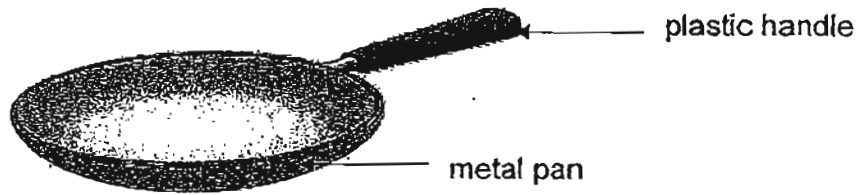

(a) The handle is made of plastic because it is a \_\_\_\_\_ conductor of heat. (1m)

(b) The pan is made of metal because it is a \_\_\_\_\_ conductor of heat. (1m)

37. Jamie used an instrument to measure the temperature of water in a basin.

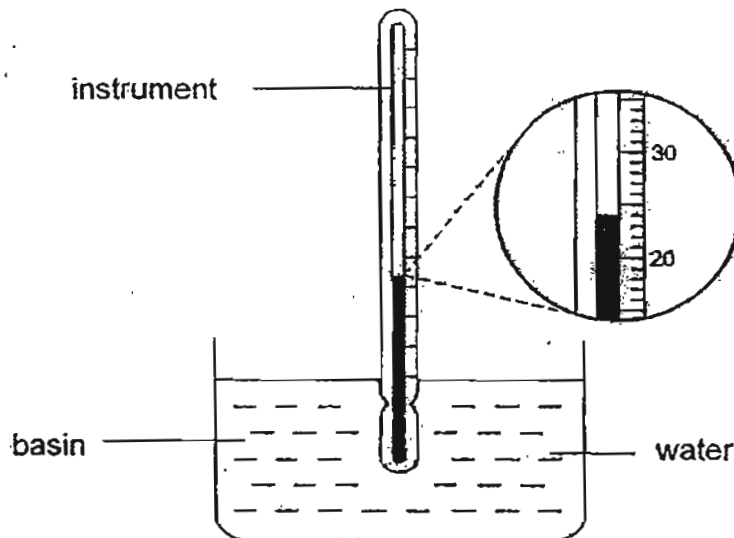

(a) What is the instrument called? (1m)

\_\_\_\_\_

37.11

37.12

(b) What is the temperature of the water in the basin? (1m)

\_\_\_\_\_ °C

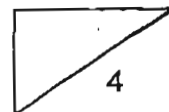

38. Hui Ling wanted to conduct an experiment to find out which material is a better conductor of heat.

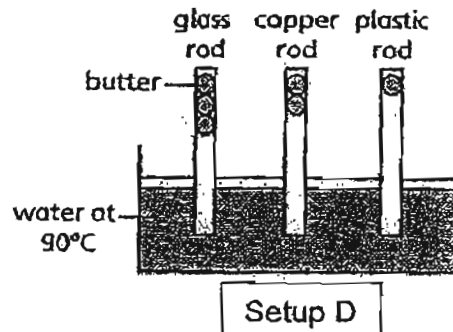
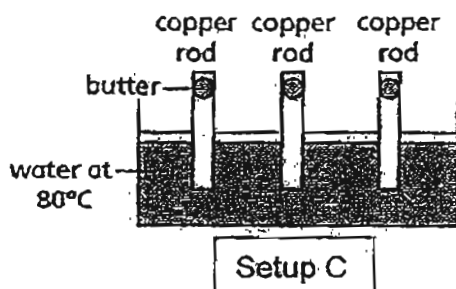
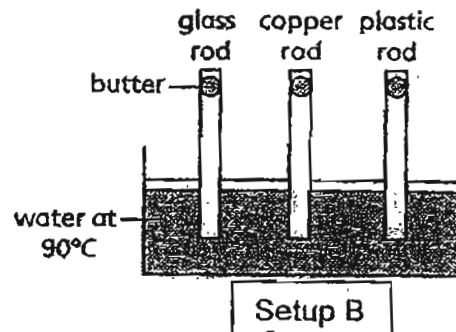
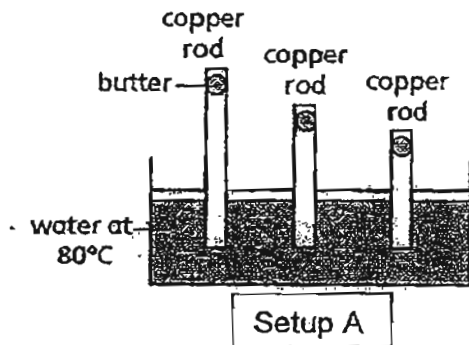

(a) Which one of the above set-ups should she use for her experiment? (1m)

Setup \_\_\_\_\_

(b) If she wanted to find out if the length of the rod affects the rate of melting, which set-up should she use then? (1m)

Setup \_\_\_\_\_

(c) Name one variable that was kept the same for part (b). (1m)

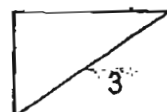

39. The diagram below shows a glass of hot tea at  $75^{\circ}\text{C}$  placed in a basin of water with a temperature of  $26^{\circ}\text{C}$ .



- a) What would happen to the hot tea after 10 minutes? (1m)

\_\_\_\_\_

- b) Fill in the blanks to indicate if the hot tea and water in the basin gain or lose heat. (1m)

Water in basin : \_\_\_\_\_ Hot tea : \_\_\_\_\_

- c) What could be the possible temperature of the hot tea after 10 minutes? (1m)

\_\_\_\_\_

40. The graph below shows the change in temperature of a cup of water.

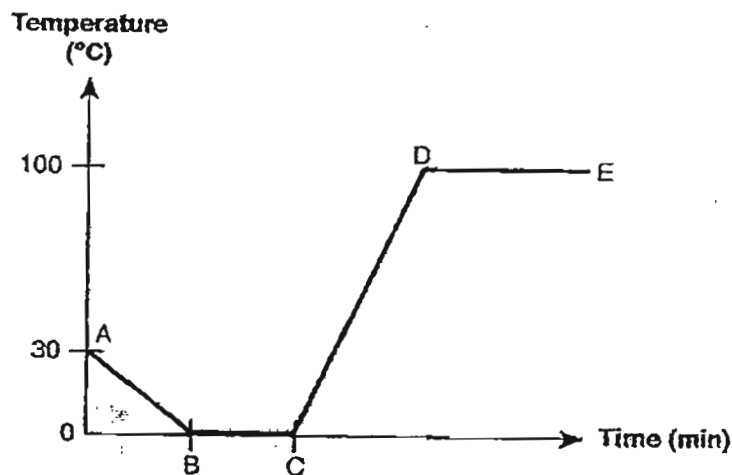

- a) Was there heat gain or heat loss from A to B? (1m)

\_\_\_\_\_

- b) What process is taking place from D to E? (1m)

\_\_\_\_\_

- c) What is the state of the water between C and D? (1m)

\_\_\_\_\_

41. An object S is placed on a table at two different positions P and Q as shown below. Object S is made up of an **opaque square base** and a **translucent extension bar**.

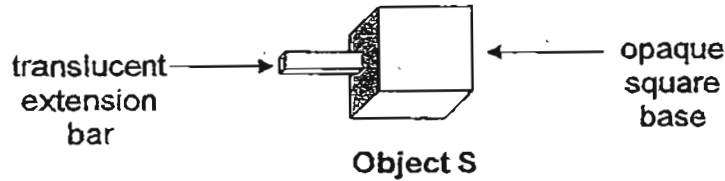

A source of light is being shone on Object S at 2 positions, as shown below:

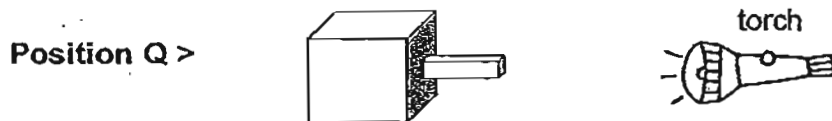
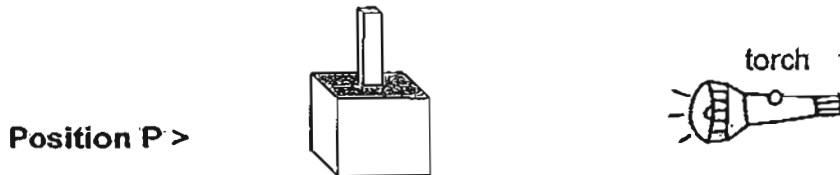

Write the letters P and Q in the brackets that represent the shadows formed with the two positions. (2m)

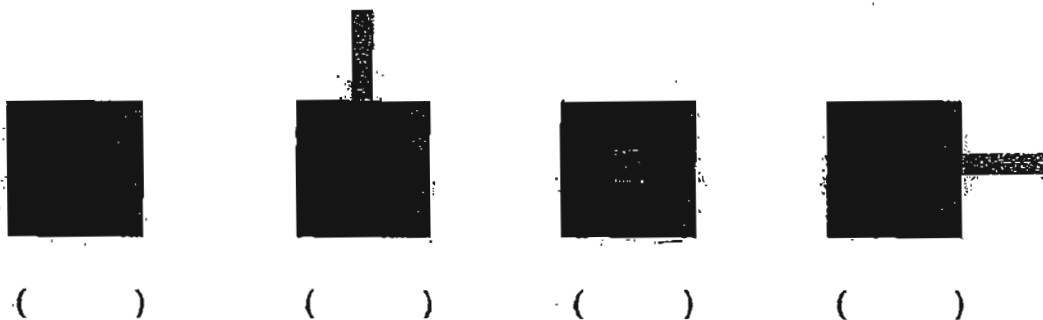

- (a) In order to form a bigger shadow, what can be done to Object S? (1m)

---

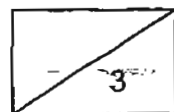

42. Study the classification chart below.

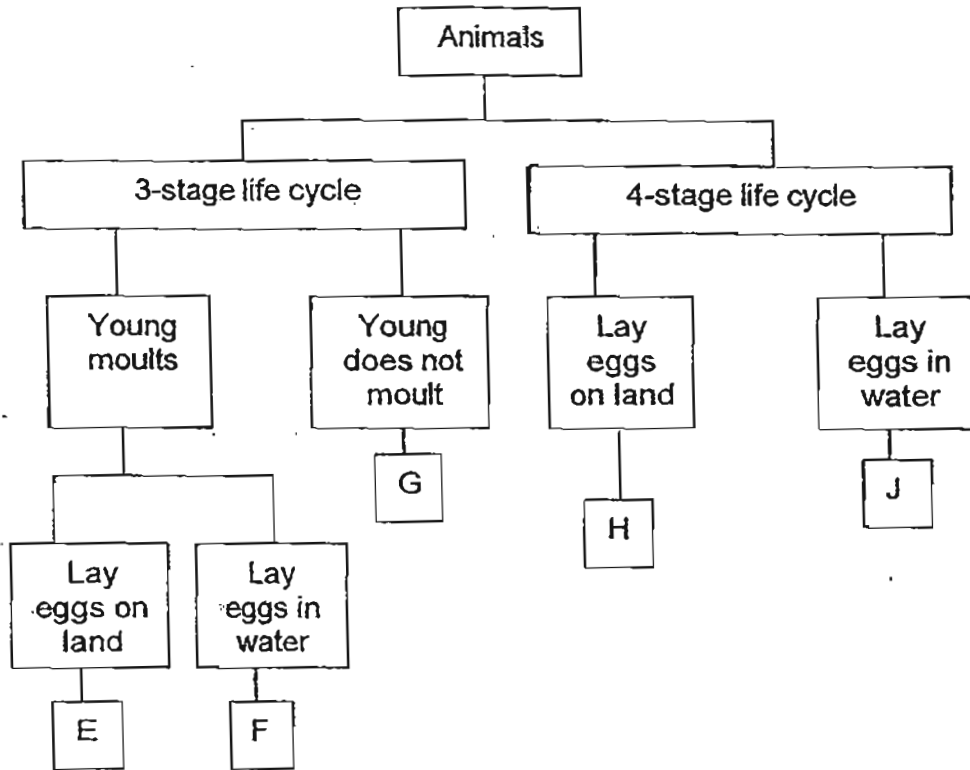

a) Describe Animal E. (1m)

---

---

b) Compare animals F and J. How are they different? (1m)

---

---

c) Which letter E, F, G, H, J would best represent the dragonfly? (1m)

---

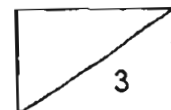

43. The diagram below shows the stages in the life cycle of a plant.

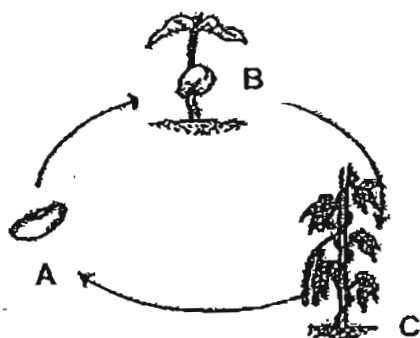

Choose the correct words from the box to answer the question below.

egg	seed	young plant	adult plant
-----	------	-------------	-------------

Name the stages, A and B in the life cycle of the plant.

A: \_\_\_\_\_ (1m)

B: \_\_\_\_\_ (1m)

44. Kim read in a book that the amount of surface area affects the rate at which ice melts. She decided to conduct an experiment to find out if it was true. Kim made two bags of ice. The ice in the two bags are of the same mass but Bag A contains several ice cubes while Bag B contains one ice block.



Bag A



Bag B

a) Which bag of ice will melt faster? Explain your answer. (2m)

---



---

b) If salt is added to ice, how will it affect the melting point? (1m)

---

c) When salt is added to ice in Bag A, will the ice melt faster or slower? (1m)

---



45. Sammy poured a cup of hot water and a cup of cold water and covered the cups with a lid as shown below. After 3 minutes, he observed some water droplets on both setups.

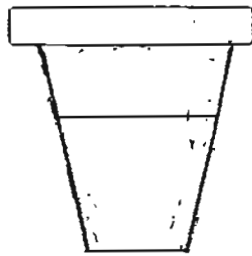

hot water at  $80^{\circ}\text{C}$

**Set-up A**

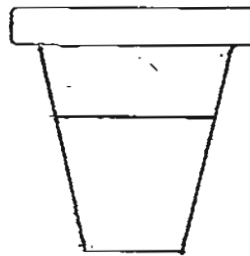

cold water at  $10^{\circ}\text{C}$

**Set-up B**

- a) Draw the water droplets in both diagrams to indicate where they are formed. (2m)
- b) If the room temperature is  $20^{\circ}\text{C}$ , in which set-up will water droplets appear first? (1m)

---

- c) Give a reason for your answer in (b). (1m)

---

---

~ End of Booklet B ~

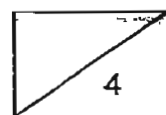





# ANSWER SHEET

**EXAM PAPER 2011**

**SCHOOL : SGCS  
SUBJECT : PRIMARY 4 SCIENCE**

**TERM : SA2**



Q1	Q2	Q3	Q4	Q5	Q6	Q7	Q8	Q9	Q10	Q11	Q12	Q13	Q14	Q15	Q16	Q17
3	2	3	3	1	2	4	3	4	4	3	1	2	1	2	2	2

Q18	Q19	Q20	Q21	Q22	Q23	Q24	Q25	Q26	Q27	Q28	Q29	Q30
3	1	2	3	1	4	3	3	3	2	4	3	4

31a) air      31b) grow      32) b – strong c-transparent e-waterproof g-light

33a) mouth      33b) small intestine

34) Part E is incorrectly drawn, Digestion is completed at Part D and food is also absorbed into the bloodstream at Part D. Part E only absorb excess water from the undigested food and no digestion takes at Part E. Thus , Part E is incorrectly drawn.

35a) The unlike poles of magnets can attract each other, allowing this device to work.

35b) Magnetism can pass through glass, allowing this advice to work.

35c) The magnets could have lost magnetism because of the hot sun and is was heated. Thus causing the device to no longer work.

36a) poor      36b) good

37a) It is called a thermometer      37b) 24

38a) B      38b) Setup A      38c) The amount of wax was kept the same.

39a) The hot tea would lose heat to the basin of water and cool down after 10 minutes.

39b) water in basin : Gain heat      Hot tea : lose heat

40a ) There was heat los from A to B

40b) The water was boiling from D to E

Page 2

40c) The water was at the liquid state between C to D.

41)

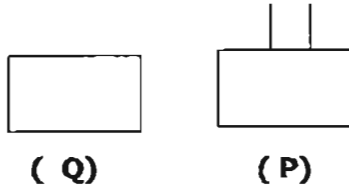

41a) Object S can be moved closer to the torch in order to form a bigger shadow.

42a ) Animal E has a three- stage life cycle,lays egg on land and its young moults.

42b) Animal F has a three-stage life cycle while animal J has a four-stage life cycle.

42c) Letter F would best represent the dragonfly.

43) A: seed                      B) young plant

44a ) bag A , the surface area is greater.

44b) The melting point is lowered.

45a)

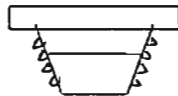

Set-up B

45b) That will happen in set-up A

45c) There will be more wter droplets as the temperature causes it to condense.

---end paper---