



RAFFLES GIRLS' PRIMARY SCHOOL
SEMESTRAL ASSESSMENT (2)
2011

Practical 10%	Your score Out of 100	
Section A 50%		
Section B 40%		
	Class	Level
Highest Score		
Average score		
Parent's Signature		

Name : _____ Index No: _____ Class: P 5 _____

28 October 2011 **SCIENCE** Attn: 1 h 30 min

SECTION A (25 X 2 marks)

For each question from 1 to 25, four options are given.
 One of them is the correct answer. Make your choice (1, 2, 3 or 4).
 Shade the correct oval on the Optical Answer Sheet.

1. The diagrams below show the reproductive systems of a flower and a human respectively.

Which part of the flower has the same function as part X of the human reproductive system?

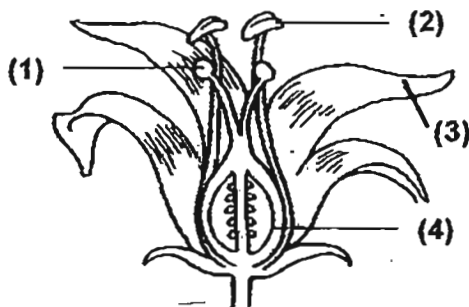

plant reproductive system

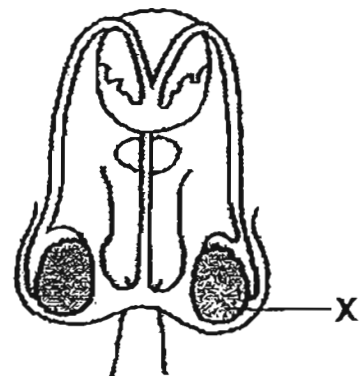

human (male) reproductive system

2. The table below shows the characteristics of 3 types of inedible fruits /seeds: P, Q and R.

fruit/ seed	size	mass	other characteristics
P	small	light	has a wing-like structure
Q	small	light	has stiff hairs
R	big	heavy	has a fibrous husk

Based on the information above, which of the following statements are true?

- A The fruits/ seeds P are dispersed by wind.
- B The fruits/ seeds Q are dispersed by animals.
- C The fruits/ seeds R are dispersed by splitting.

(1) A and B only

(2) A and C only

(3) B and C only

(4) A, B and C

3. Miss Tan placed a different number of similar plants without their roots in 3 identical beakers: A, B and C.

The beakers contained the same amount of water. An equal amount of oil was poured in beakers A and B as shown in the diagrams below.

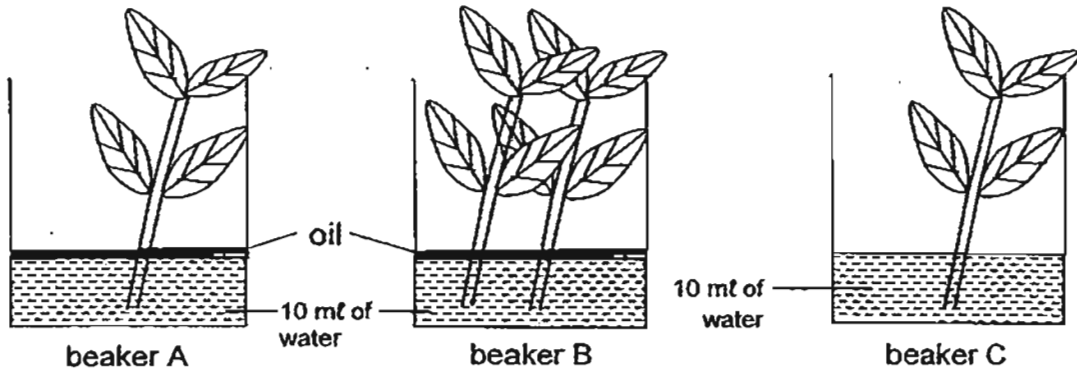

Miss Tan's pupils observed the amount of water left in each beaker after four days.

The pupils then plotted a graph as shown below:-

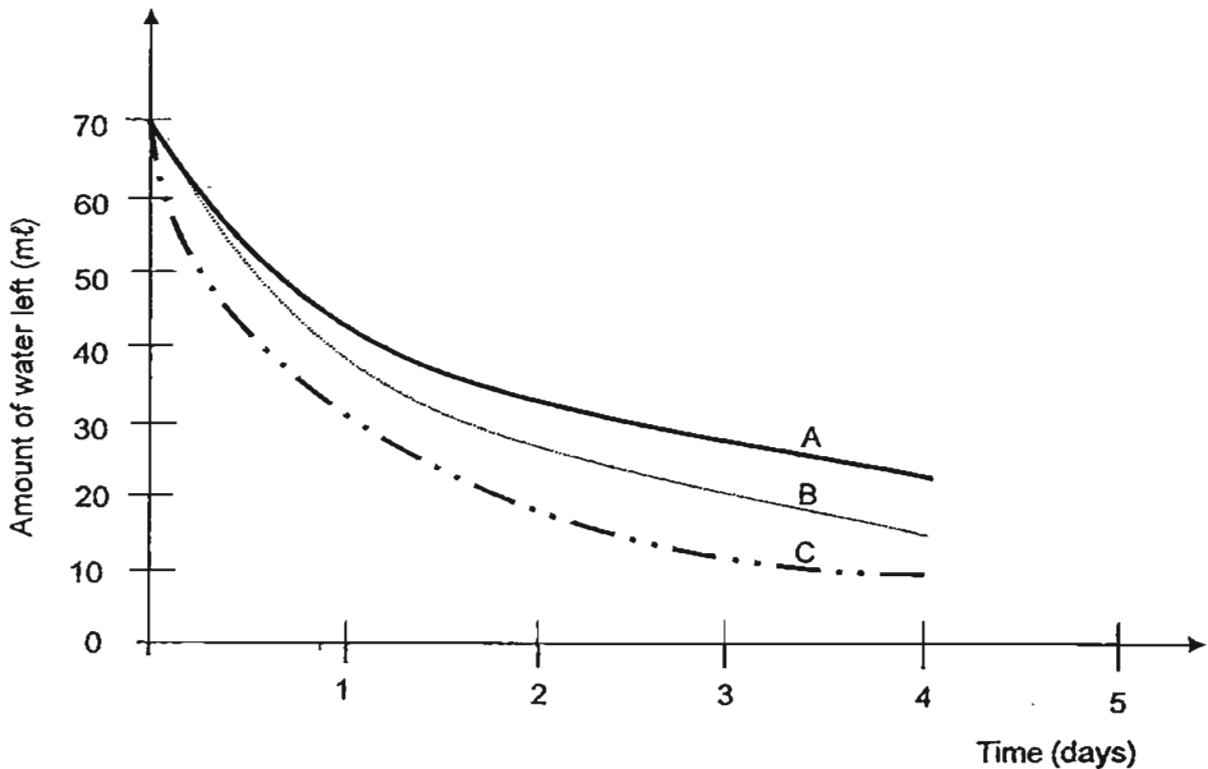

Key	
amount of water left in beaker A	—————
amount of water left in beaker B
amount of water left in beaker C	- . - . - . -

continue on the next page

Continue from the previous page

Based on the results of the graph, three of Miss Tan's pupils made the following statements:

Michelle : The plants took in water by their stems.

Amanda : Water had evaporated from beakers A and B as the plants had no roots to take in water.

Natalie : Less water was left in beaker B than A as there were more plants in beaker B to take in water.

Which of Miss Tan's pupils made the correct statements?

- (1) Michelle and Amanda only
- (2) Michelle and Natalie only
- (3) Amanda and Natalie only
- (4) Michelle, Amanda and Natalie

4. Which one of the following describes the function of each different organ in the digestive system correctly?

	stomach	small intestine	large intestine
(1)	water and mineral salts are absorbed	food mixes with digestive juices	blood transports digested food to the rest of the body
(2)	food mixes with digestive juices	blood transports digested food to the rest of the body	water and mineral salts are absorbed
(3)	digestive juices are added, digestion is completed here	water and mineral salts are absorbed	blood transports digested food to the rest of the body
(4)	blood transports digested food to the rest of the body	digestive juices are added, digestion is completed here	water and mineral salts are absorbed

5. The diagram below shows the flow of blood to and from the heart.

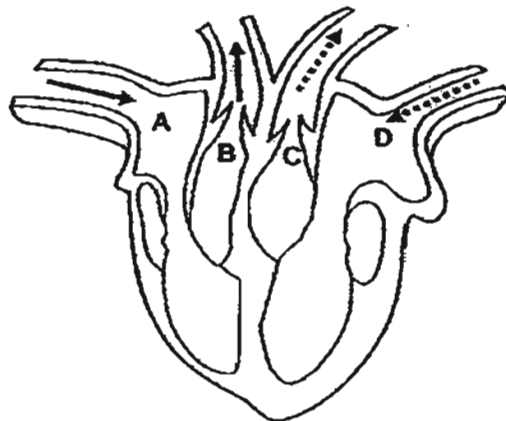

KEY	
.....→	blood <u>rich in oxygen</u>
—→	blood <u>rich in carbon dioxide</u>

A, B, C and D are parts found in the heart.

Which one of the following describes the direction of blood flow correctly?

	A	B	C	D
(1)	from lungs	to lungs	to other parts of the body	from other parts of the body
(2)	from lungs	to other parts of the body	to lungs	from other parts of the body
(3)	from other parts of the body	to lungs	to other parts of the body	from lungs
(4)	from other parts of the body	to other parts of the body	to lungs	from lungs

6. A boy had some food stuck in his throat and was not able to breathe easily. A hollow breath tube was inserted into his throat, as shown in the diagram below, to help him breathe.

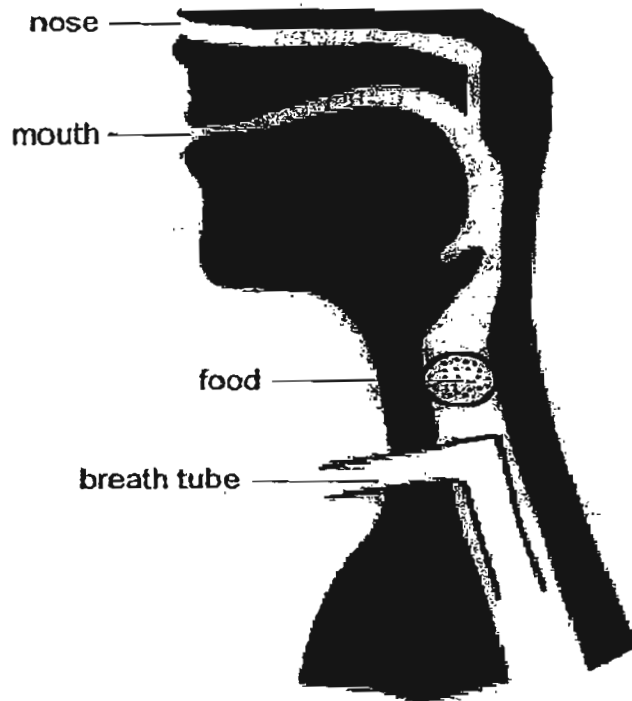

Based on the diagram above, which one of the following shows the correct path taken by air in the boy's body?

- (1) breath tube → lungs → all parts of his body
- (2) nose → windpipe → lungs → all parts of his body
- (3) mouth → windpipe → lungs → all parts of his body
- (4) breath tube → windpipe → lungs → all parts of his body

7. The table below provides some information on three types of cells: A, B and C. A tick (✓) indicates the presence of the part of a cell.

part of cell	cell A	cell B	cell C
nucleus	✓	✓	✓
cytoplasm	✓	✓	✓
chloroplast			✓
cell wall	✓		✓

Which one of the following identifies correctly where cells A, B and C are likely to be taken from?

	cell A	cell B	cell C
(1)	root	leaf	onion
(2)	root	cheek	onion
(3)	onion	cheek	leaf
(4)	cheek	onion	leaf

8. Five rats were placed in an air-tight jar for several hours. Water vapour is given out when the animals respire.

Which one of the following shows the correct changes in the composition of air in the jar?

	water vapour	oxygen	carbon dioxide
(1)	decrease	increase	decrease
(2)	increase	no change	decrease
(3)	increase	decrease	increase
(4)	no change	decrease	increase

9. The number of times a heart beats per minute to pump blood in a body is the pulse rate. A more physically fit person pumps blood fewer times than a less physically fit person.

A physically fit and a physically unfit person ran up a steep hill. Next, they walked down the same hill.

Which one of the following graphs shows the correct pulse rates of these two people?

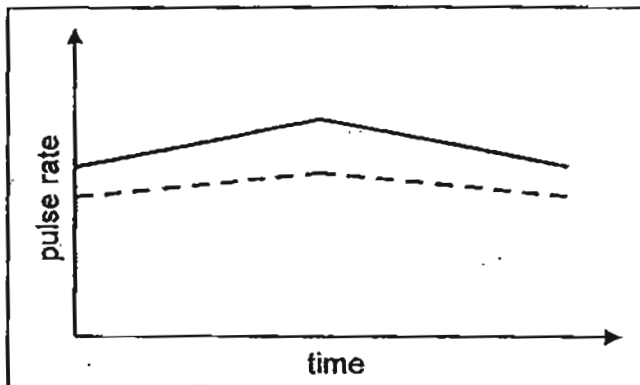
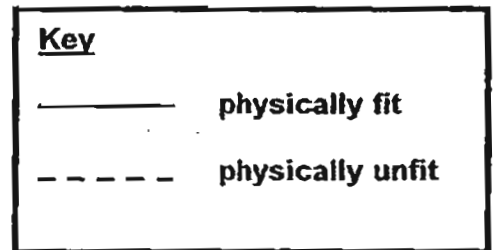

(1)

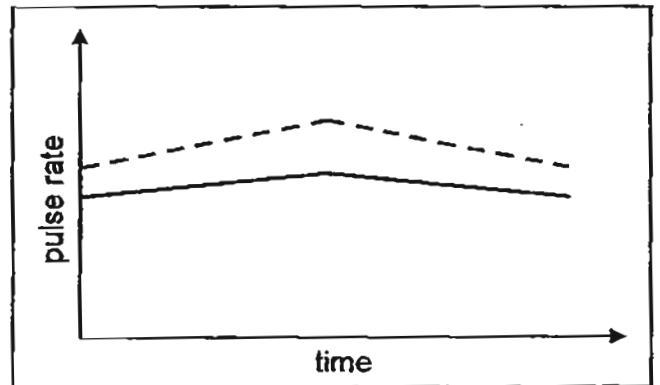

(2)

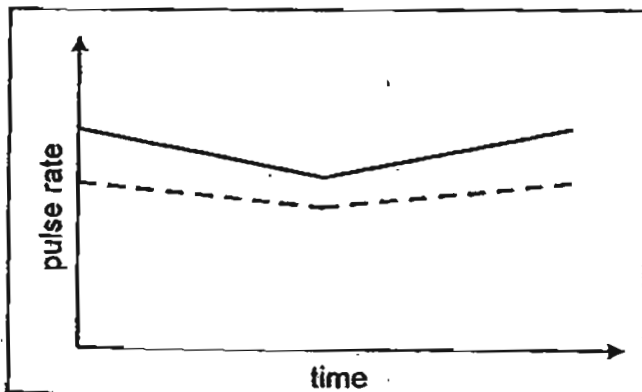

(3)

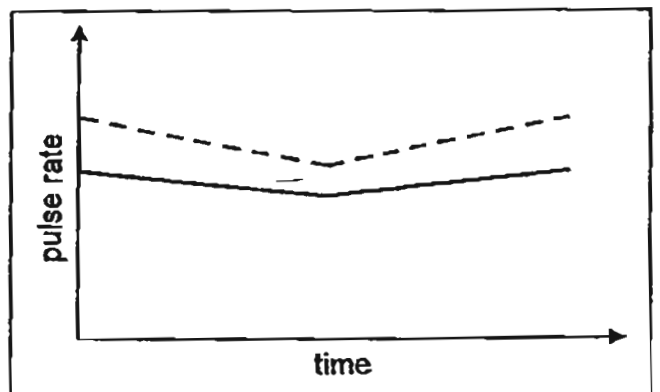

(4)

10. Sarah collected 4 different types of materials, A, B, C and D, to find out which material is the hardest. She scratched each material, one at a time, using her fingernail, a wooden spoon and an iron rod.

Her results are shown in the table below.

A tick (✓) indicates a scratched mark on the material.

material	can be scratched with a fingernail	can be scratched with a wooden spoon	can be scratched with an iron rod
A	✓	✓	✓
B			✓
C			
D		✓	✓

Which one of the following shows the correct arrangement of these materials in order of increasing hardness?

	increasing hardness 			
(1)	A,	B,	C,	D
(2)	A,	D,	B,	C
(3)	C,	B,	D,	A
(4)	C,	D,	B,	A

11. The diagram below shows an overview of the water cycle on Earth.

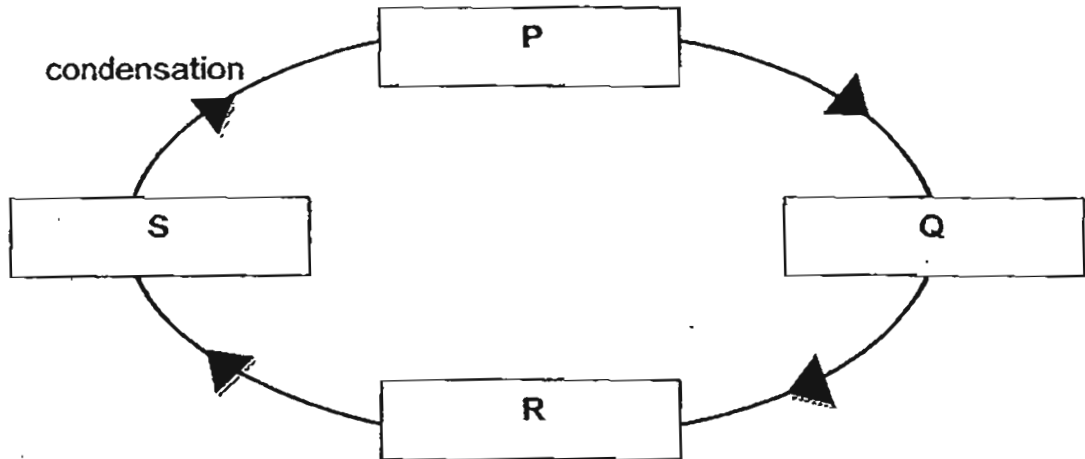

What does P represent?

- (1) rain
- (2) clouds
- (3) water vapour
- (4) water on Earth

12. Sara poured a different amount of water into three different containers, A, B and C, as shown below.

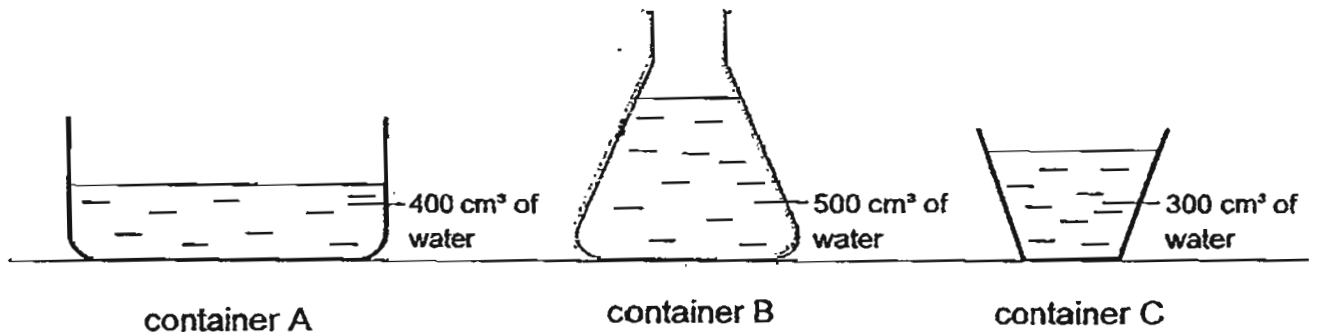

Sara left the three containers in a room.

Which one of the following gives the most likely amount of water evaporated from each container after three days?

	from container A (cm ³)	from container B (cm ³)	from container C (cm ³)
(1)	30	50	40
(2)	40	30	50
(3)	40	50	30
(4)	50	30	40

13. Hugo has a cup which is caved in at its base as shown below.

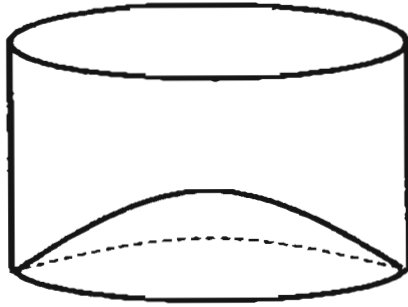

empty cup

He poured 500 cm^3 of very hot water into the cup and left it on a table as shown below.

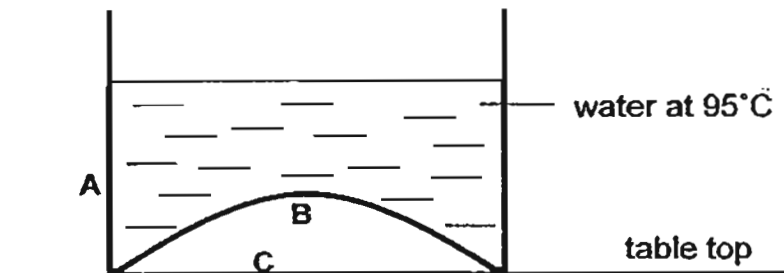

After 3 minutes, Hugo observed that water droplets were found around the mouth and other part(s) of the cup/ table.

Which other part(s) of the cup/ table could Hugo observe water droplets?

- (1) B only
- (2) C only
- (3) A and B only
- (4) A and C only

14. Jerry had 4 set-ups using identical fans, containers of water and equal amount of drying agent as shown below. The drying agent used in the experiment removes water vapour from the air in the sealed boxes. Jerry placed each set-up in identical sealed boxes at a constant temperature.

Which set-up would contain the most amount of water in the container at the end of 2 days?

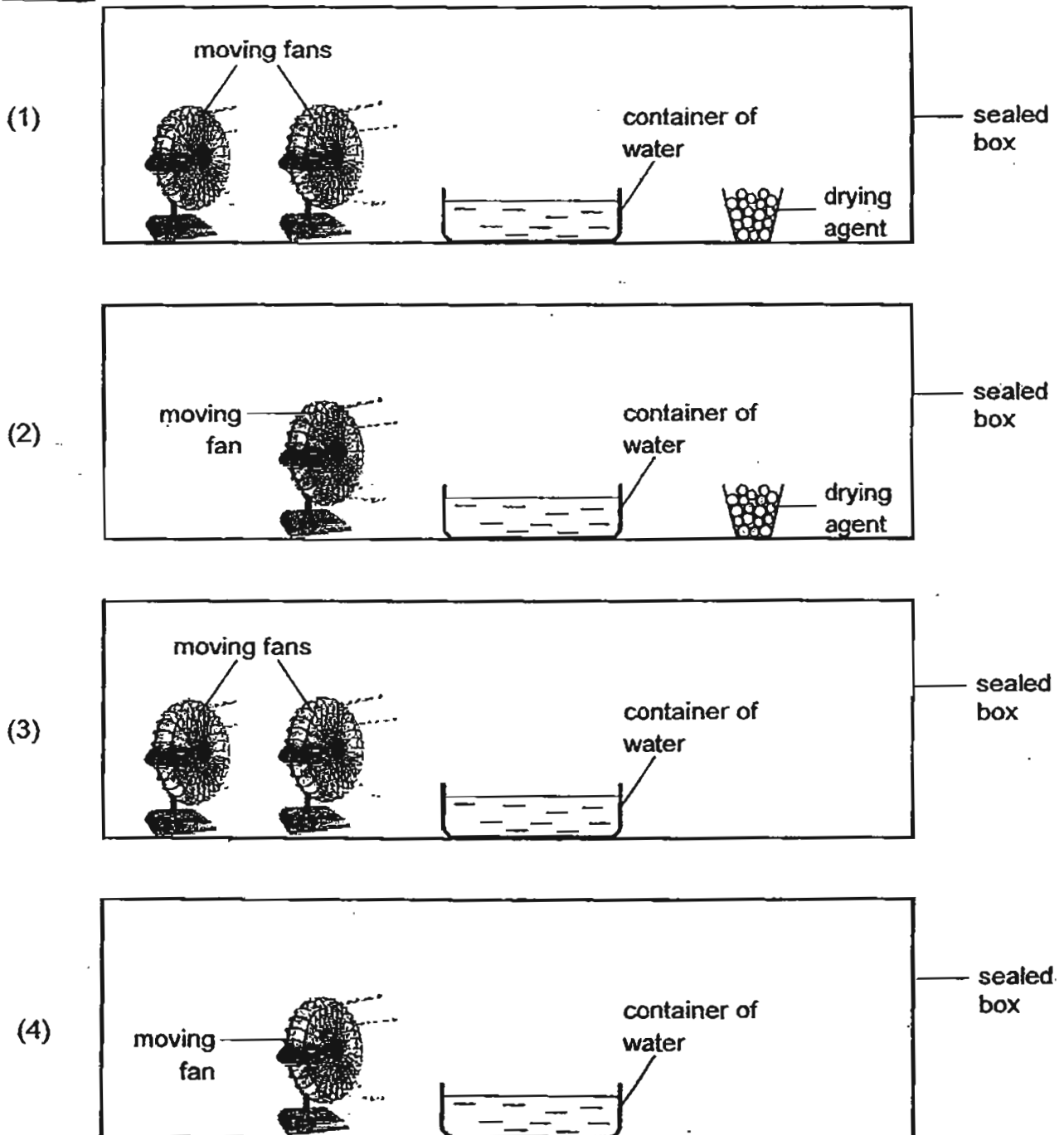

15. At 8 a.m., the shadow of Bala's flat was as shown below.

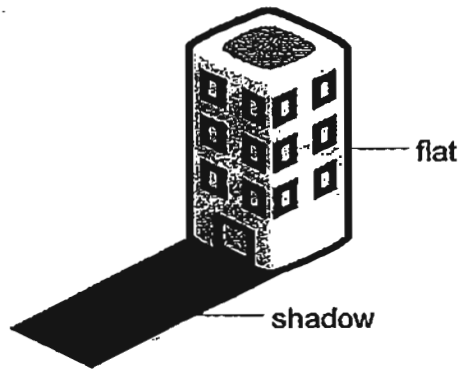

Which one of the following diagrams shows the shadow of Bala's flat at 6.30 p.m.?

(1)

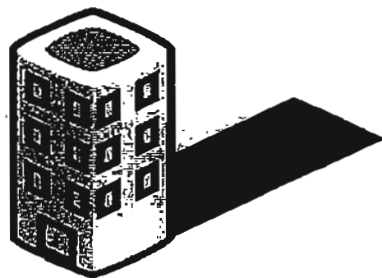

(2)

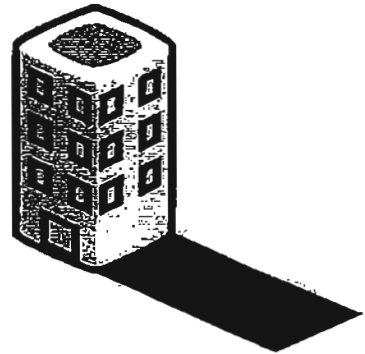

(3)

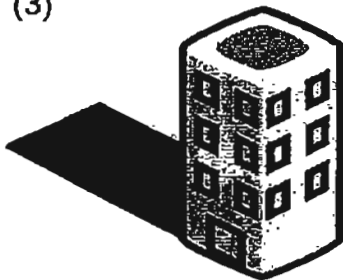

(4)

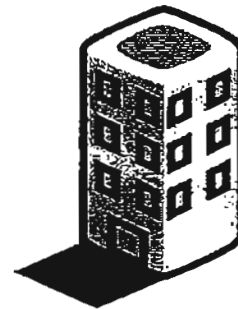

16. Ming is cycling along a narrow path and Dylan is walking along the same path as Ming.
Two tall buildings are blocking their views of each other.

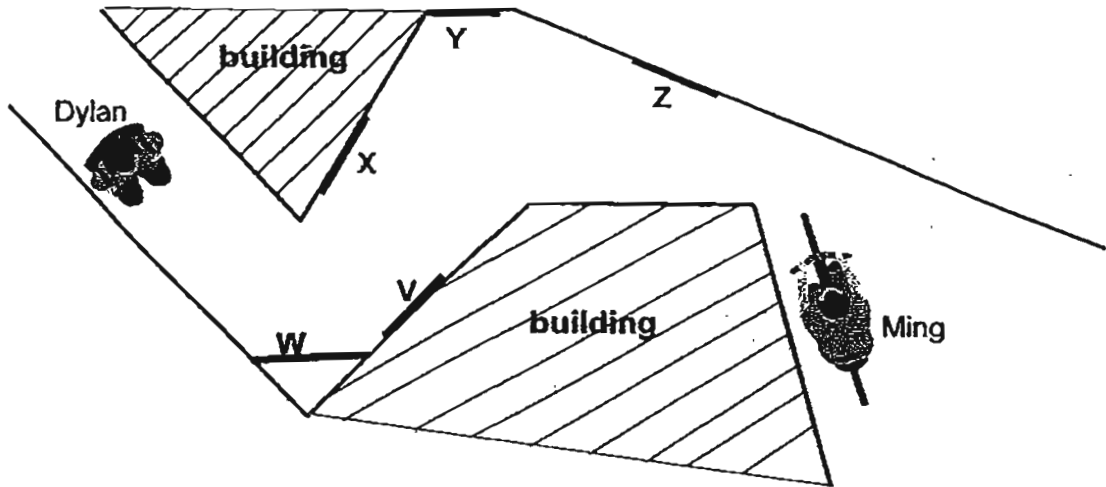

Where should the two mirrors be placed along the path such that Ming can see Dylan from where both are now, in their positions as shown above?

- (1) V and X
- (2) V and Y
- (3) W and Y
- (4) W and Z

17. Ali set up the experiment as shown below.

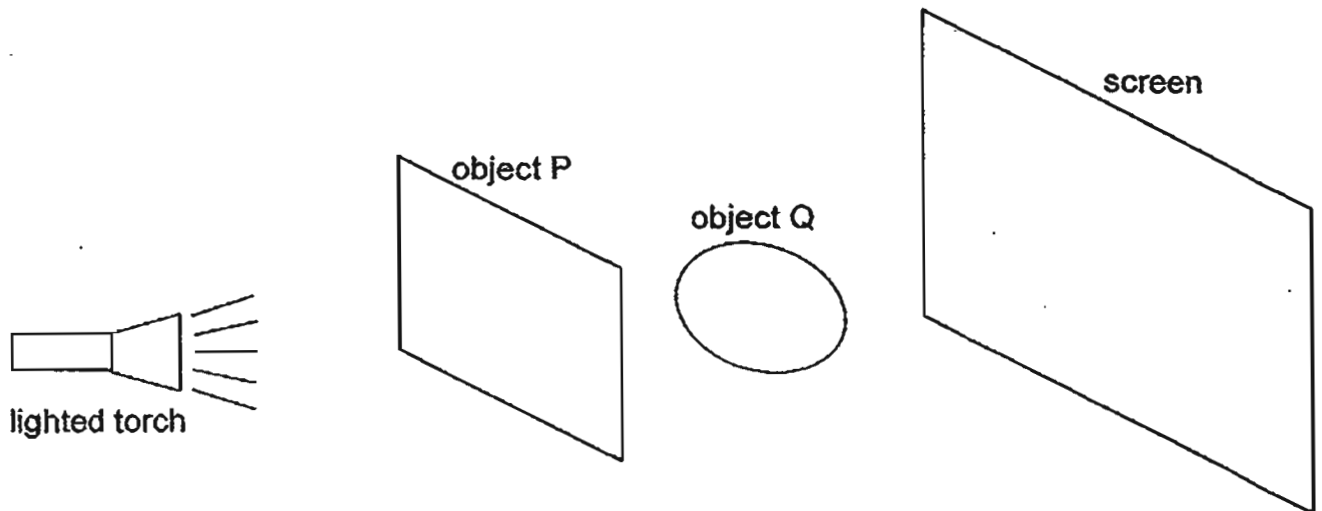

The shadows Ali observed on the screen are as shown below.

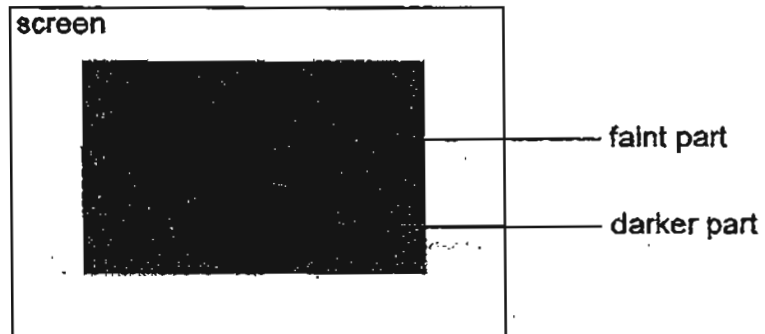

Which one of the following describes objects P and Q correctly?

- (1) Both objects P and Q were opaque.
- (2) Both objects P and Q were transparent.
- (3) Object P was translucent but object Q was opaque.
- (4) Object P was translucent but object Q was transparent.

18. A lighted candle was placed beneath a copper rod at X for three minutes as shown in the diagram below.

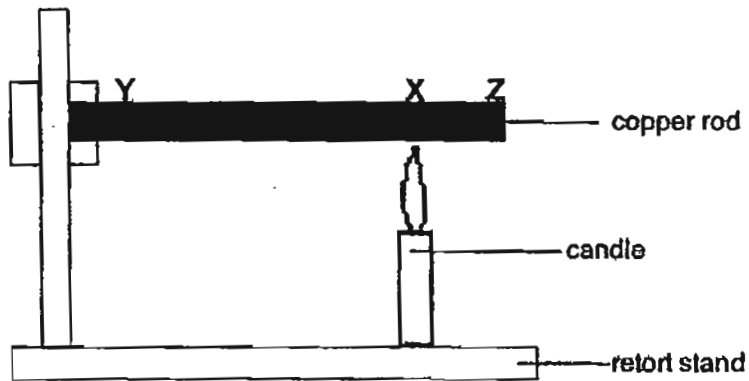

Which one of the following shows the correct degree of hotness at points X, Y and Z?

	hottest →		
(1)	X	Y	Z
(2)	Y	X	Z
(3)	Y	Z	X
(4)	Z	Y	X

19. Four pupils conducted an experiment to observe the effects of heat on matter. An empty metal bottle with a cork stopper was being heated over a fire as shown below.

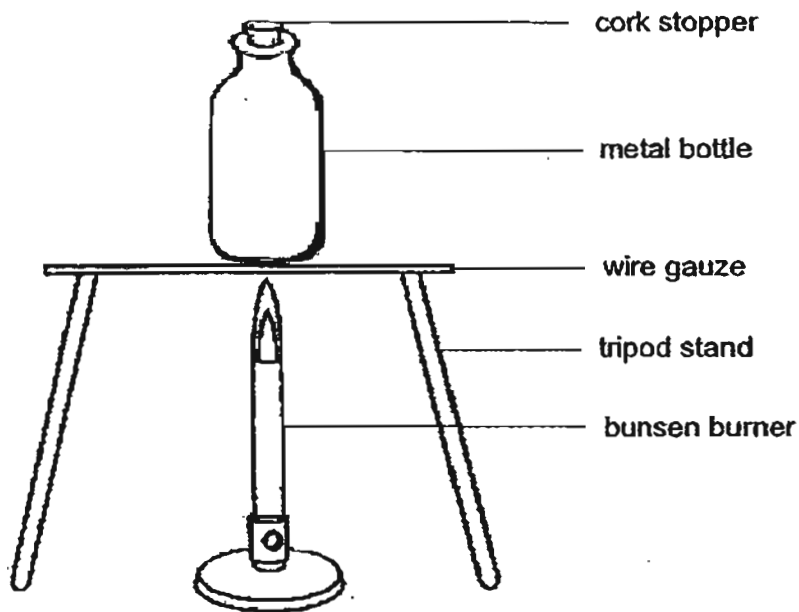

After a while, the cork stopper popped out of the metal bottle. Each pupil made the following statements:

- Ali : Fire gained heat from the bottle.
Ben : Heat was transferred from the fire to the metal bottle.
Camdu : Air inside the bottle expanded and pushed the stopper out.
Ding Hui : Air inside the bottle contracted and pushed the stopper out.

Which of these pupils made the wrong statement(s)?

- (1) Camdu only
(2) Ali and Ding Hui only
(3) Ben and Camdu only
(4) Ben and Ding Hui only

20. "Teh tarik" is a hot tea beverage which is poured back and forth repeatedly between two containers from a height. The picture below shows a man preparing "teh tarik".



Which one of the following describes the heat transfer that has taken place?

- (1) The tea transferred its heat to the surrounding air to cool down more quickly.
- (2) The tea gained heat from the surrounding air to become hotter more quickly.
- (3) The man transferred heat to both containers to maintain the temperature of the tea.
- (4) Heat from one container was transferred to the other to ensure that the temperature of the tea remained unchanged.

21. Four different materials were used to test whether a light bulb would light up in an electric circuit.

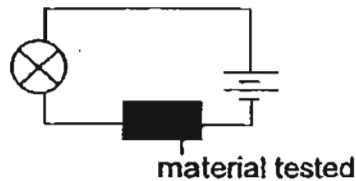

material	Did the bulb light up?
A	yes
B	yes
C	no
D	no

The four materials were then used to make four similar containers of the same size and volume. The containers were completely filled with water at room temperature of 30°C and left on the ground under the sun at noon for some time as shown below.

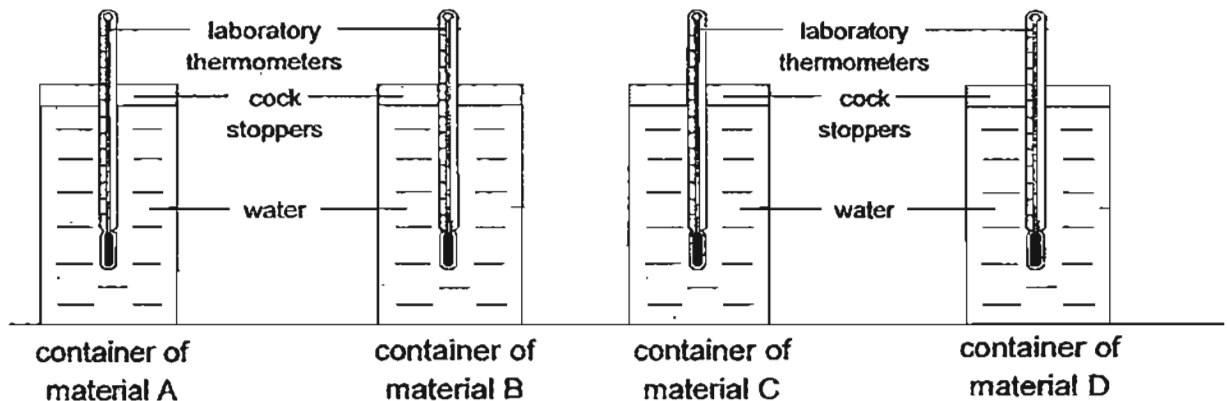

Of the four materials, A, B, C and D, only two were good conductors of heat.

Which one of the following is most likely the temperature of the water in the four containers after 30 minutes?

	temperature of water (°C) in			
	container of material A	container of material B	container of material C	container of material D
(1)	30	31	40	42
(2)	31	42	30	40
(3)	40	30	42	31
(4)	42	40	31	30

22. David connected various components in the circuit below to find out how bulb X can glow most brightly.

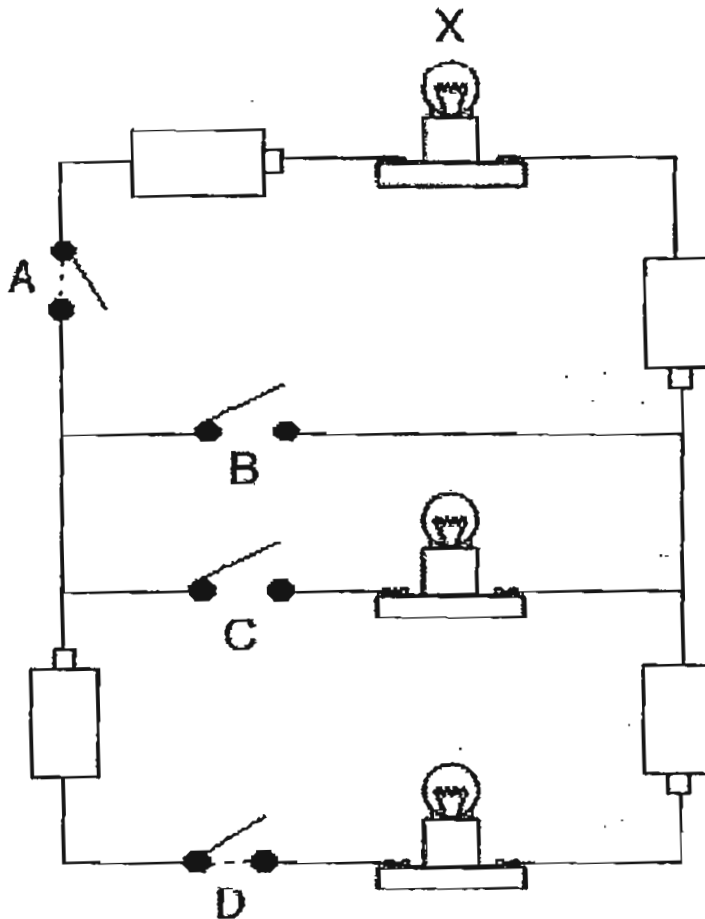

How should David connect the switches to enable bulb X to glow most brightly?

	switch A	switch B	switch C	switch D
(1)	open	open	closed	closed
(2)	open	closed	open	closed
(3)	closed	open	open	closed
(4)	closed	open	closed	open

23. Alec connected a bell to an electric circuit to find out which object(s) was an /were electrical conductor(s).

Switches J, K and L and objects A, B, C and D were connected in the circuit as shown below.

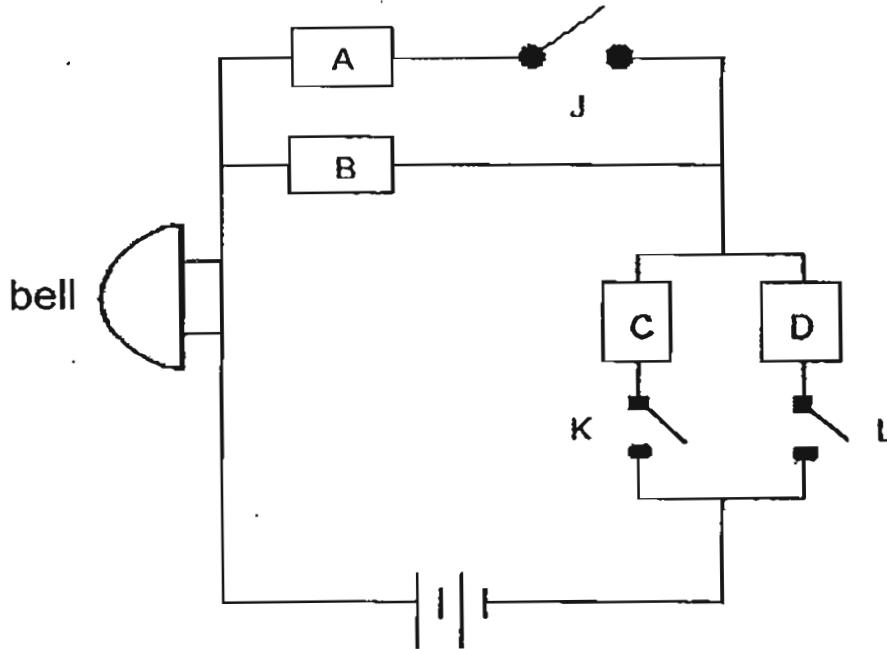

Alec recorded his observations as shown in the table below.

switch J	switch K	switch L	Did the bell ring?
closed	open	open	no
open	closed	open	yes
open	open	closed	yes
closed	closed	open	yes

Which one of the following can Alec conclude?

	Object A	Object B	Object C	Object D
(1)	cannot tell	electrical conductor	electrical insulator	electrical insulator
(2)	cannot tell	electrical conductor	electrical conductor	electrical conductor
(3)	electrical insulator	electrical insulator	electrical insulator	electrical conductor
(4)	electrical insulator	electrical conductor	electrical insulator	electrical conductor

24. The diagram below shows the arrangement of 4 bar magnets.

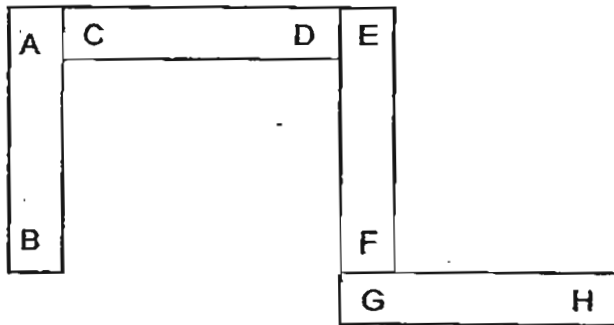

Which one of the following diagrams shows a possible arrangement of these bar magnets?

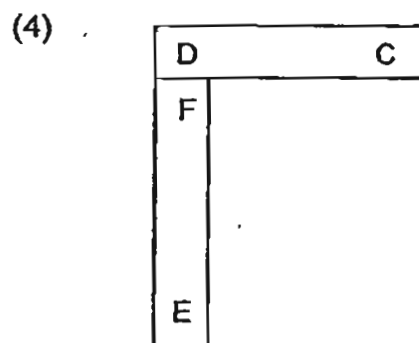
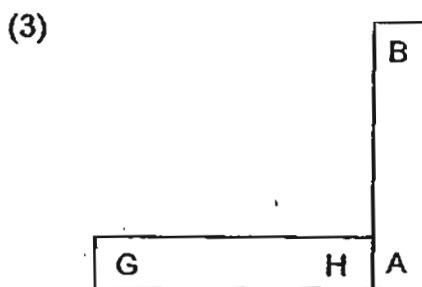
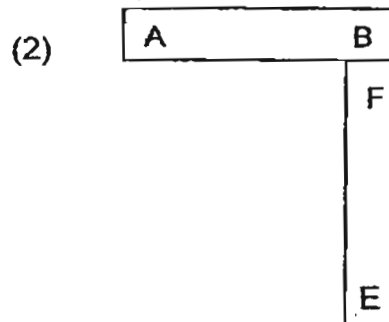
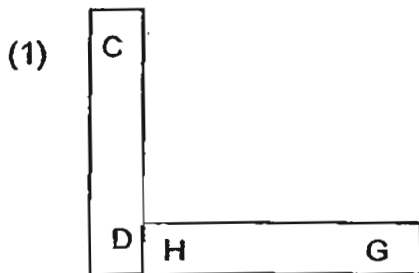

25. Joy placed objects X and Y on both ends of a lever. The lever slanted to one end as shown below.

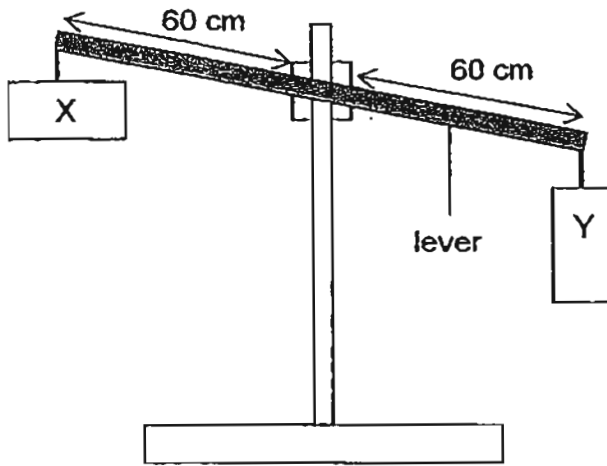

Next, Joy placed object A directly below Y and observed that the lever balanced as shown in the diagram below.

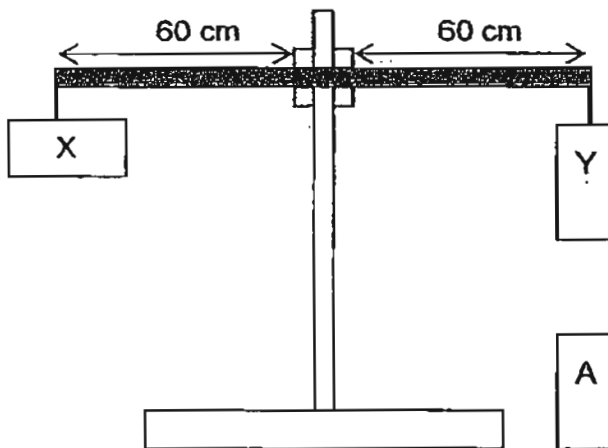

Which one of the following best explains Joy's observation?

- (1) Y was lighter than X.
- (2) A and Y were magnets.
- (3) A, X and Y were magnets.
- (4) X and Y were of the same mass.



Name : _____ Index No : _____ Class : P5 _____

SECTION B (40 marks)

For questions 26 to 39, write your answers clearly in the spaces provided.

The number of marks available is shown in the brackets [] at the end of each question or part question.

26. Devi wanted to find out if the stems of plants transport water.

She placed a plant in a beaker which was filled with 100 ml of red-coloured water. She poured a layer of oil on the surface of the red-coloured water. She left the set-up in the classroom overnight.

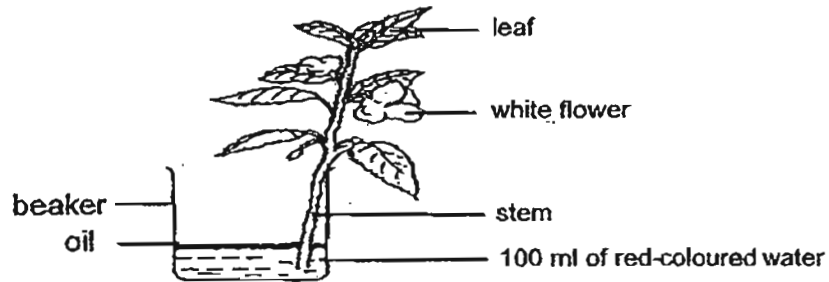

What would Devi observe of the white flower the next day?

Explain Devi's observation.

[2]

27. One Sunday, Tom recorded his pulse rate using a monitor pulse watch while he was engaging in several activities, one at a time. Within the period of his recording, he slept, jogged, rested and listened to soothing music. At the end of the day, Tom plotted the graph as shown below to show the changes of his pulse rate for the day.

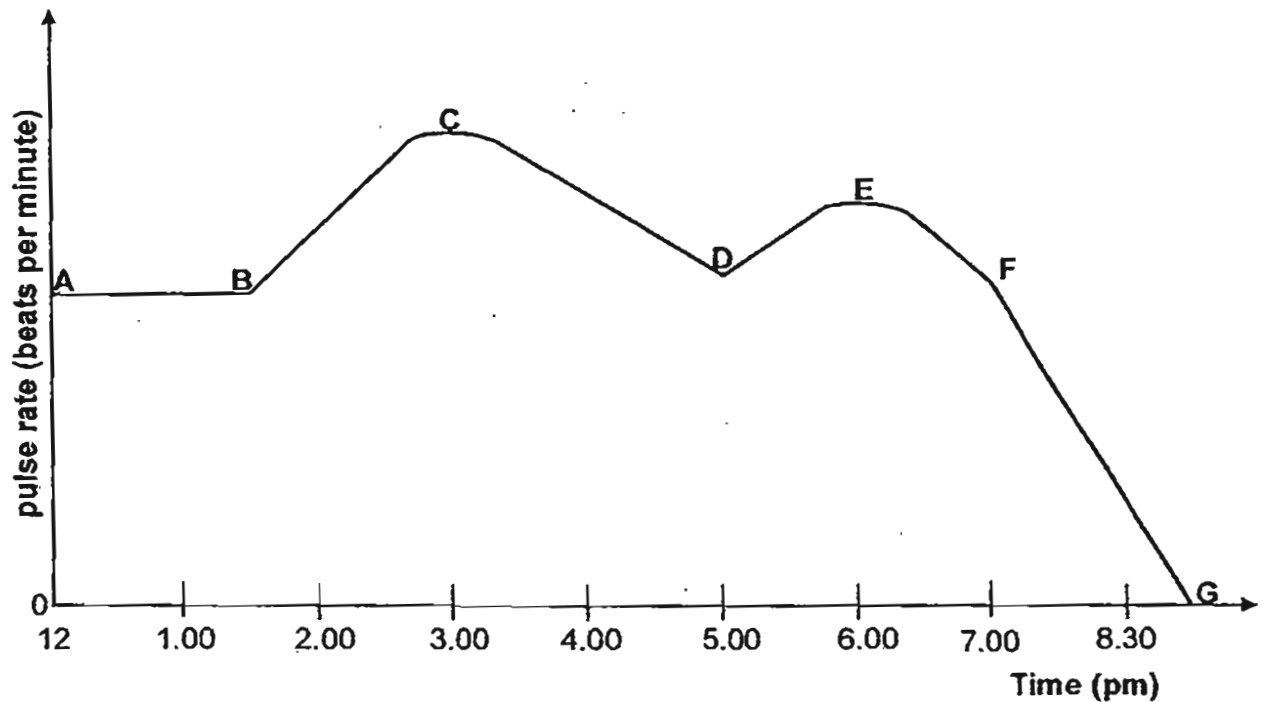

Based on the information above, answer the following questions:

- (a) Which part(s) of the graph show(s) Tom's pulse rate as he was jogging? Explain your answer. [2]

From point _____ to point _____

After 7 p.m., Tom was listening to soothing music. His mother commented that Tom had made an error in plotting line FG in his graph.

- (b) Was Tom's mother correct? Explain your answer. [2]

28. The diagram below shows a cell.

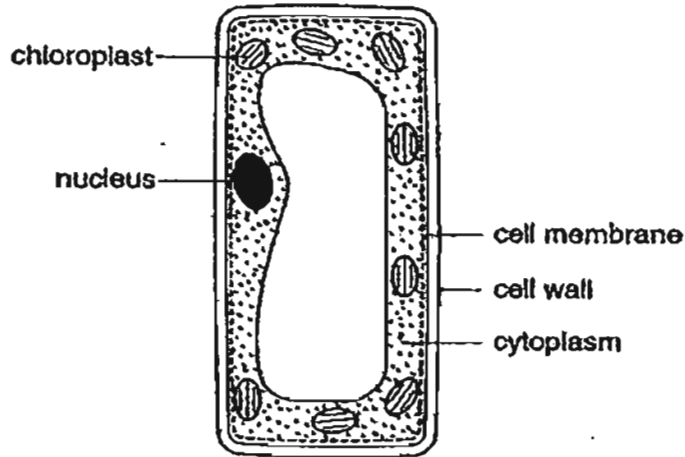

(a) State a function of the nucleus. [1]

(b) Sathia says, "It is a plant cell."
Give a reason why the above cell is **NOT** an animal cell. [1]

29. Tom went to a pet shop and bought some fish. When he got home, he placed the fish in a tank of water as shown below.

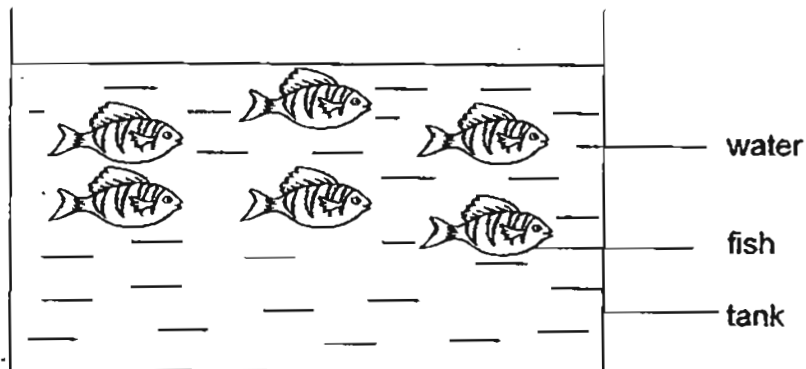

- (a) After some time, Tom observed that all the fish swam to the surface of the water. Explain why. [1]

Tom added an air pump into the fish tank. He observed that the fish did not swim to the surface of the water anymore.

- (b) What was the purpose of the air pump? [1]

30. When a cigarette burns, a harmful gas X is formed. Gas X can enter a person's blood from the lungs.

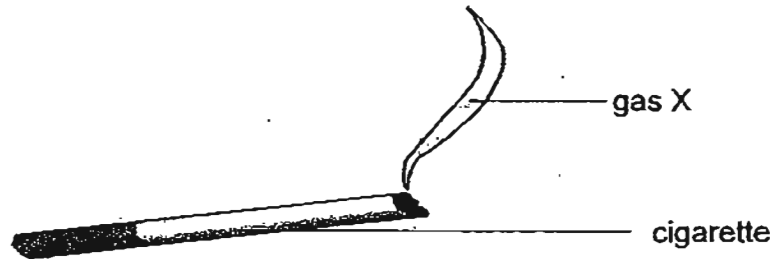

The table below shows the oxygen level in the blood of a smoker and non-smoker.

	amount of oxygen in the blood leaving the heart to the rest of the body (%)
smoker	90
non-smoker	97

Based on the information above, explain why a smoker becomes out of breath more easily than a non-smoker when both are running.

[2]

31. Emily poured 500 ml of hot water into 3 containers, each made of a different material, P, Q and R.

The containers were of the same size and thickness.

She used a temperature sensor to measure the temperatures of the water in the 3 containers at 2-minute intervals and recorded them in the table below.

time (min)	temperature of water in container (°C)		
	of material P	of material Q	of material R
0	80	80	80
2	79	74	77
4	78	68	73
6	78	61	69
8	76	55	66
10	74	50	62

Emily wanted to find out which material, P, Q and R, is most suitable to transport blocks of ice.

- (a) Based on the information above, which material, P, Q and R, is most suitable to make a box to transport blocks of ice? Explain your answer. [2]

- (b) The thickness of each of the containers was kept constant to ensure a fair test. Explain why this was important in Emily's experiment. [2]

32. The diagram below shows a pump fitted to a container.

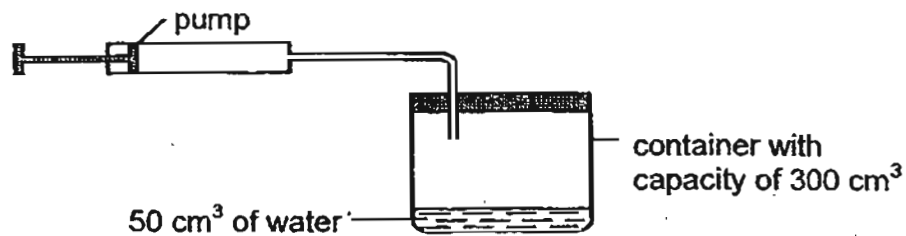

Each time the pump was pushed in completely, 100 cm³ of air would enter the container.

Based on the information above, answer the following questions:

- (a) State the volume of air in the container after the pump was pushed in completely 3 times. [1]

- (b) On the graph below, draw a line graph to show the relationship between the total volume of air in the container and the number of pumps until air could **NO** longer be pumped into the container. [1]

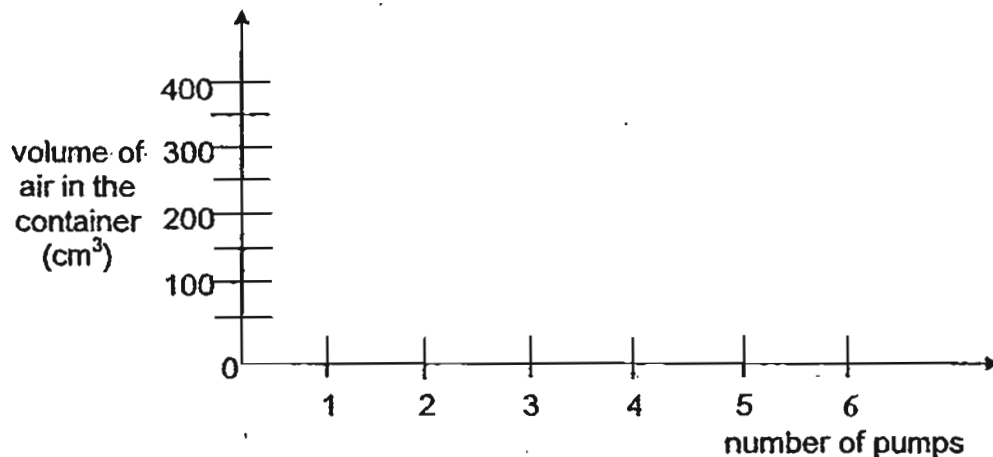

Air has no definite volume.

- (c) State another property of air that was demonstrated in this experiment. [1]

33. The table below shows the freezing and boiling points of four unknown substances: W, X, Y and Z.

substance	freezing point (°C)	boiling point (°C)
W	22	110
X	30	75
Y	10	200
Z	28	450

Based on the information above, answer the following questions:

- (a) Which of these substances is a solid / are solids at 15 °C?

Put a tick (✓) in the correct box(es) below.

[1]

W	X	Y	Z

Pure substance Y is now at 200 °C. Mary continues to heat it for another 15 minutes.

- (b) State the temperature of substance Y at the 15th minute.

[1]

34. Ali connected an electric fan to an electric circuit. He used the following apparatus to determine whether wind has an effect over a tray containing 1000 ml of water.

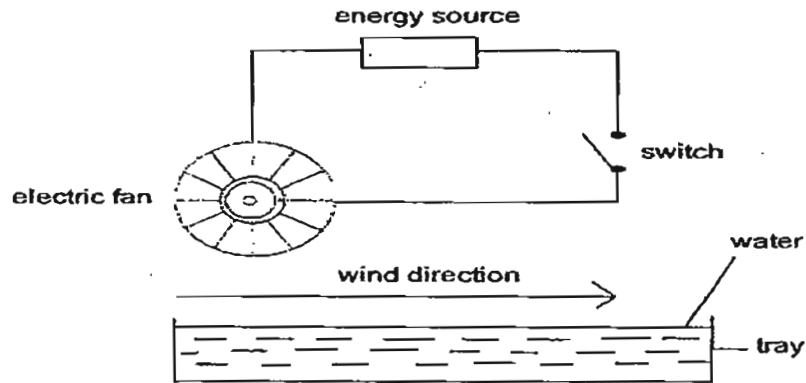

- (a) Based on the information above, what would happen to the water level in the tray after a while when the switch was closed? Explain your answer. [2]

Ali increased the speed of the electric fan and recorded his results in the table as shown below.

speed of electric fan (turns/ sec)	amount of water left in the tray (ml)
2	950
3	820
4	690

- (b) State the relationship between the speed of wind created by the electric fan and the rate of evaporation of water in the tray. [1]

- (c) Name one variable that Ali must keep constant for him to conduct a fair test. [1]

35. Marshall filled three identical cups with an equal amount of water and oil.

One cup contained water at room temperature, another cup contained water at 5°C and another cup contained water at 16°C. He placed all the cups on identical digital scales as shown below.

He left the three set-ups, W, X and Y, in a room. The temperature of the room was kept at 30°C. He recorded the masses after a short while.

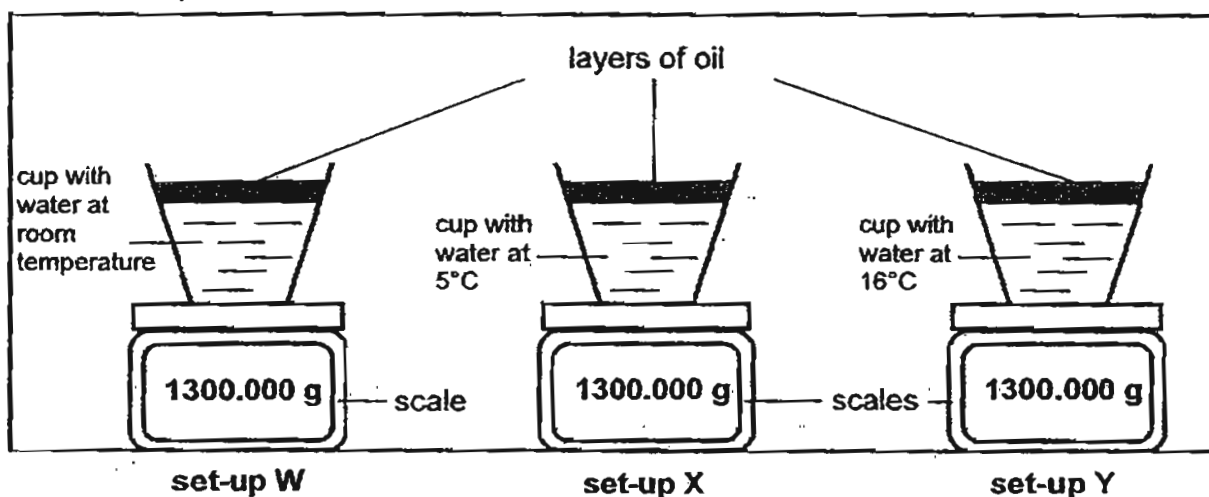

Marshall observed that the mass of the cup and its contents in set-up X was greater than that in set-up Y after a short while.

(a) Explain Marshall's observations. [2]

continue on the next page

Continue from the previous page

Marshall observed that the mass of the cup of water and oil in set-up W remained unchanged after another 3 minutes.

- (b) Based on Marshall's observations of set-up W ONLY, what was the relationship between the **temperature difference** between the water in the cup and its surrounding, and its mass recorded after 3 minutes?
[1]

36. Kevin carried out an experiment to compare the amount of light each material reflects and allows to pass through it in a dark room.

He fixed the positions of the light source, materials and data loggers A and B as shown below.

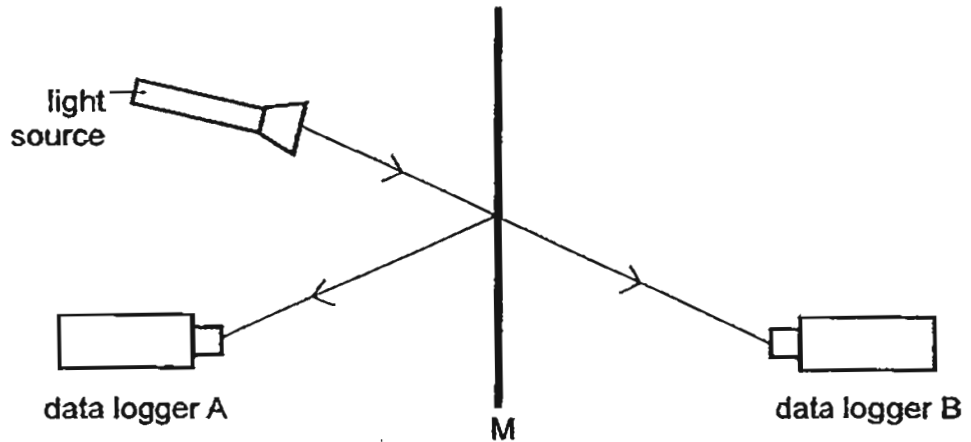

He placed a different material at M, one at a time.

Kelvin recorded his results in Table 1 below.

material	amount of light received by data logger A (Lux)	amount of light received by data logger B (Lux)
aluminium	2000	0
clear glass	330	1800
R	1300	900

Without changing the positions of the light source and data loggers, A and B, Kevin flipped over each material to compare the amount of light each material reflects and allows light to pass through on its other side.

He recorded his results in Table 2 below.

material	amount of light received by data logger A (Lux)	amount of light received by data logger B (Lux)
aluminium	1700	0
clear glass	330	1800
R	1300	900

continue on the next page

Continue from the previous page

- (a) Based on the results in Tables 1 and 2, give a reason why data logger B detected **NO** light when the aluminium foil was placed at M. [1]

Lee was playing in a brightly-lit room while James was in a dark room next to Lee's. The window that separated the boys' rooms was made of material R.

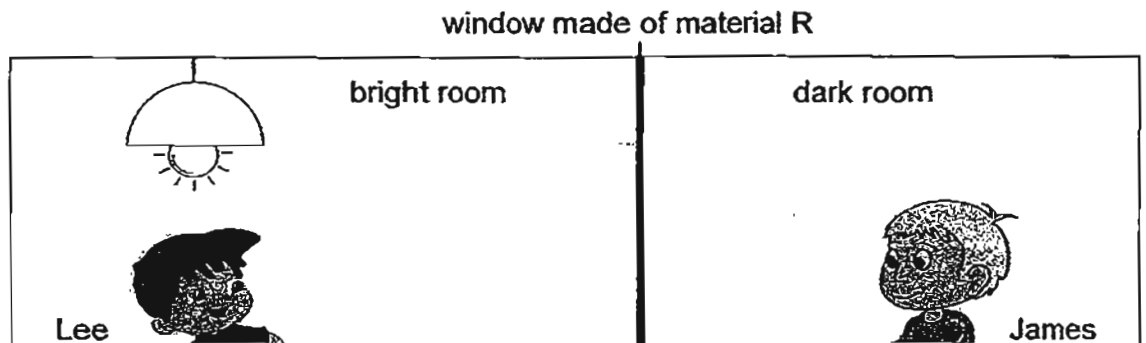

Only very little amount of light passed through the window from James' room into Lee's room. Hence, Lee saw **ONLY** his own reflection but could not see James. James could see Lee through the window.

- (b) Based on Kevin's experiment about the property of material R, explain why Lee saw **ONLY** his own reflection but could not see James through the window made of material R. [2]

	explanation
Lee saw ONLY his own reflection on the window made of material R	
Lee could not see James through the window made of material R	

37. Richard filled completely three conical flasks, X, Y and Z, of the same size and thickness with an equal volume of black liquid A of the same initial temperature. He placed all the flasks at the same time into a tray of hot water.

The diagram below shows the final observations Richard made at the end of his experiment.

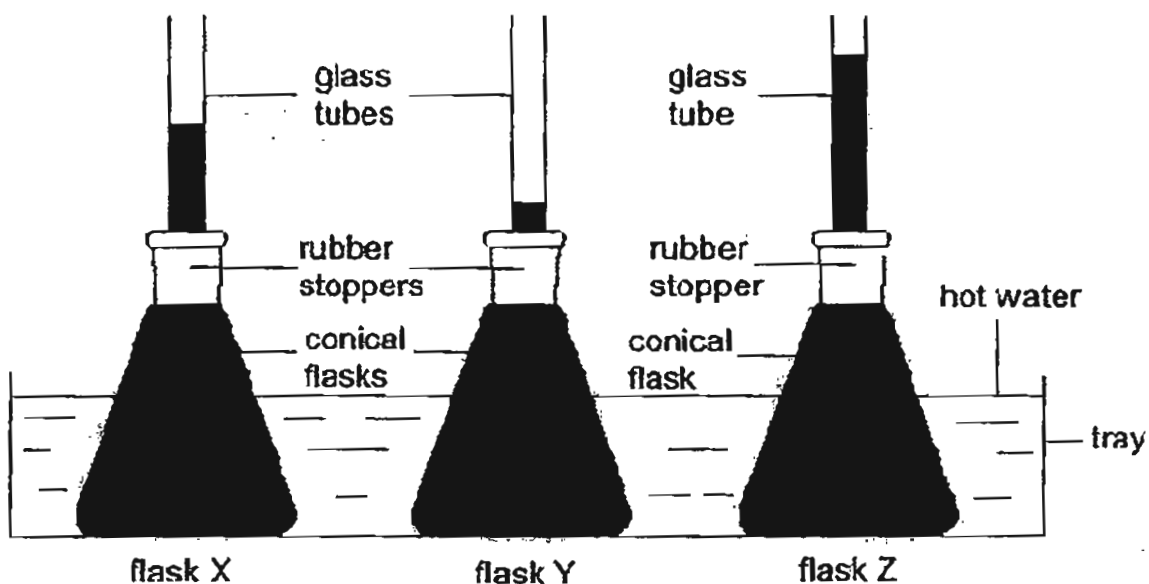

- (a) Based on the information above, arrange the flasks in order, according to the rate of expansion of black liquid A in each conical flask. [1]

slowest

fastest

Next, Richard placed all the three flasks in a tray of cold water. He noticed that the black liquid A in the glass tubes of all the three flasks rose slightly before it dropped.

- (b) Explain why the black liquid A rose slightly at first. [2]

- ~~38~~ Sally connected identical bulbs and batteries to form a circuit. She realised that one of the bulbs did **NOT** light up even though she had replaced it with several new ones.

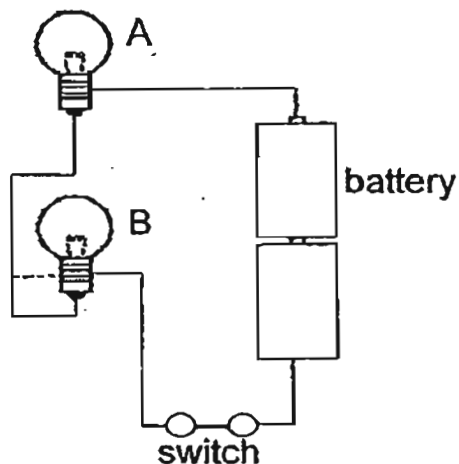

- (a) Based on the information above, identify the bulb which did **NOT** light up when the switch was closed and give a reason why it was so. [1]

bulb	reason

- (b) Using the same set-up, **DRAW** wires to connect the various components in the circuit such that Sally could light up both bulbs. [2]

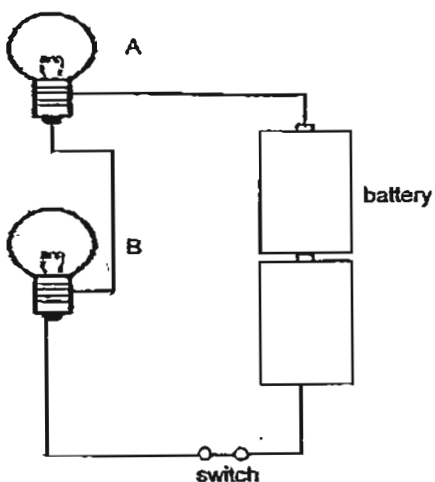

39. Sarah carried out an experiment to find out if the thickness of an equal length of bar magnets affects its strength over a fixed distance.

She had the following materials for her experiment.

magnet A 

magnet B 

magnet C 

 20 of such paper clip(s)



a 30-cm ruler

Describe how Sarah could carry out her experiment using all the materials above. [3]

Note: You do not need to use all the spaces provided below to write the steps.

step	procedure
1	Place the S-pole of magnet A at the 1-cm mark of the ruler.

- END OF PAPER -

Setters: Mr Jonathan Teo, Ms Lee Suan Khim, Ms Lim Li. Shan

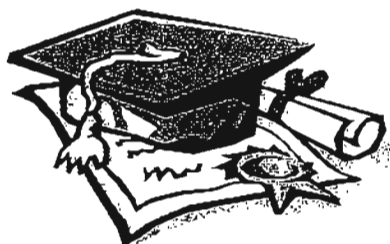

ANSWER SHEET

EXAM PAPER 2011

**SCHOOL : RAFFLES GIRLS'
SUBJECT : PRIMARY 5 SCIENCE**

TERM : SA2

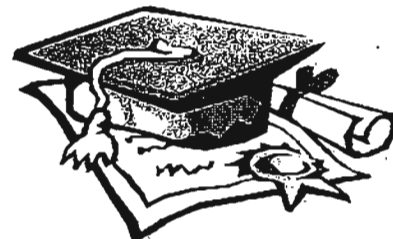

Q1	Q2	Q3	Q4	Q5	Q6	Q7	Q8	Q9	Q10	Q11	Q12	Q13	Q14	Q15	Q16	Q17
2	1	2	2	3	4	3	3	2	2	2	4	2	4	1	4	3

Q18	Q19	Q20	Q21	Q22	Q23	Q24	Q25
3	2	1	4	3	2	2	2

26) The white flower would turn red. The water-carrying tubes transported the red-coloured water to the white flower.

27a) Point B to C

As Tom was exercising, his heart pumped faster to transport blood that is rich in oxygen to all parts of his body to produce more energy.

b) Yes. Tom's pulse rate could not possibly reach 0 as that would indicate death.

28a) It is to pass on genetic materials.

b) The above cell contains a cell wall which is absent in an animal cell.

29a) There was more dissolved oxygen near the water surface than other parts of the tank.

b) It helped to provide more dissolved oxygen for the fish.

30) Gas X reduces the amount of oxygen absorbed into the bloodstream. The amount of oxygen in the blood leaving the smoker's heart to the rest of the body is less than a non-smoker's. Hence, the smoker does not receive sufficient oxygen to produce enough energy when running.

31a) Material P. The drop in temperature after 10 minutes is the least for Material P. Hence, Material P is the poorest conductor of heat among the three materials.

b) It is to ensure that any change in the temperature of the water in the container is caused only by the difference in the material of the container and not by the thickness of each of the containers.

32a) 250 cm^3

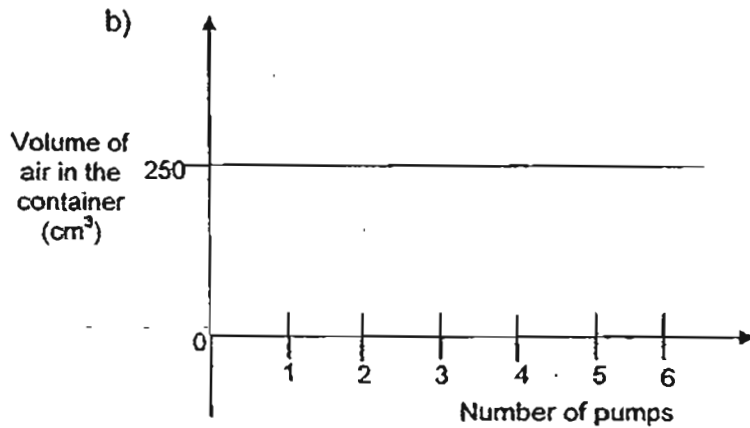

c) Air can be compressed.

33a)

W	X	Y	Z
✓	✓		✓

b) 200°C .

34a) The water level decrease. The electric fan produced wind which increased the rate of evaporation of water.

b) As the speed of wind created by the electric fan increases, the rate of evaporation of water in the tray increases.

c) The initial temperature of the water.

35a) Water in Set-up X has a lower temperature than that in set-up Y. More water vapour will condense on the cooler outer surface of the cup in set-up X than in set-up Y. Thus, forming more water droplets.

b) When there is no temperature difference between the water in the cup and its surrounding temperature, its mass recorded after 3 minutes would remain unchanged.

36a) Aluminium foil is an opaque material.

b) Lee saw **ONLY** his own reflection on the window made of material R:

Light that shines on Lee is reflected from him onto material R. Some light is reflected from material R into his eyes.

Lee could not see James through the window made of material R:

Only some light that passes material R, shines on James and is reflected from him onto material R. However, only some light passes through material R and shines into Lee's eyes.

37a) flask Y, flask X, flask Z

b) The three flasks contracted at first as they lost heat to the cold water. Liquid X thus rose slightly as the volume of the three flasks decreased.

39) 1) Place the S-pole of magnet A at the 1-cm mark of the ruler.

2) Place the 20 paper clips at the 30-cm mark of the ruler.

3) Record the number of paper clips attracted to magnet A.

4) Repeat step 1 to 3 using magnet B and C one at a time.