



PEI HWA PRESBYTERIAN PRIMARY SCHOOL
SEMSTRAL ASSESSMENT 1

PRIMARY 5
SCIENCE
13th May 2016

(BOOKLET A)

Name: _____ ()

Class: Primary 5 Loyalty _____

Additional Material(s): Optical Answer Sheet (OAS)

Total time for Booklets A and B: 1 h 45 mins

INSTRUCTIONS TO CANDIDATES

1. Write your Name, Class and Index No. at the spaces provided above.
2. DO NOT turn over the page until you are told to do so.
3. Follow all instructions carefully.
4. Answer all questions.
5. Shade your answers on the Optical Answer Sheet (OAS) provided.

There are a total of 18 pages in this booklet, excluding the cover page.

For each question from 1 to 28, four options are given. One of them is the correct answer. Make your choice (1, 2, 3 or 4) and shade your answer on the Optical Answer Sheet.

(56 marks)

1 Plants can be classified as _____.

- A land or water
- B poisonous or non-poisonous
- C flowering or non-flowering
- D reproductive or non-reproductive

- (1) A and B only
- (2) A, B and C only
- (3) B, C and D only
- (4) A, B, C and D

2 Ali kept 2 identical pieces of bread, A and B, in a dark cupboard as shown below. Ali added some water to Bread B only. Three days later, he observed that mould was present on both pieces of bread. However, there was more mould growing on Bread B than on Bread A.

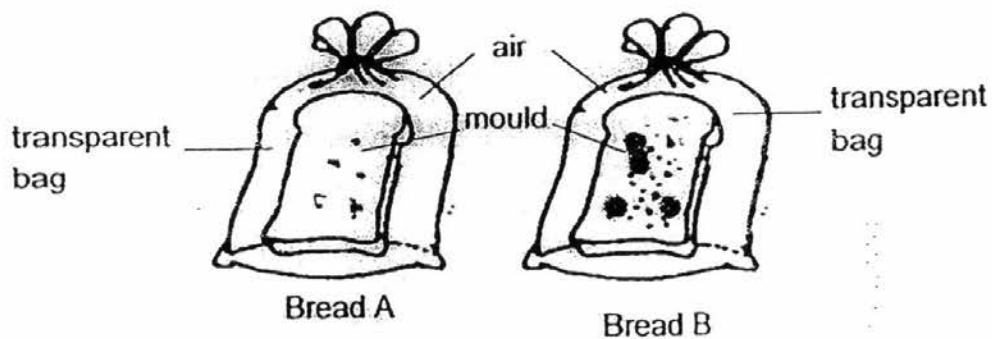

Based on the above observation, what could Ali conclude from his experiment?

- (1) Mould needs air to grow.
- (2) Mould needs sunlight to grow.
- (3) Yeast in the bread causes the mould to grow.
- (4) Mould grows faster when there is more moisture.

- 3 Mei Mei cut out a strip from four different materials, W, X, Y and Z. Each strip was of similar size and thickness. The strips were hung from a stand such that one end of the tip was dipped into a container of coloured water.

She left the strips dipped in the coloured water for 1 hour and drew her observation as shown below. The parts stained by the coloured water are shaded.

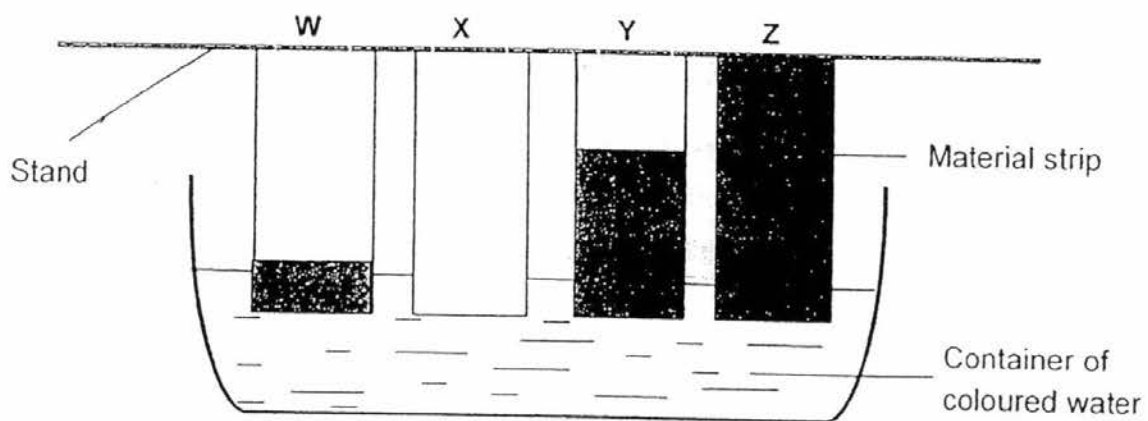

The diagram below shows a window with Part A labelled.

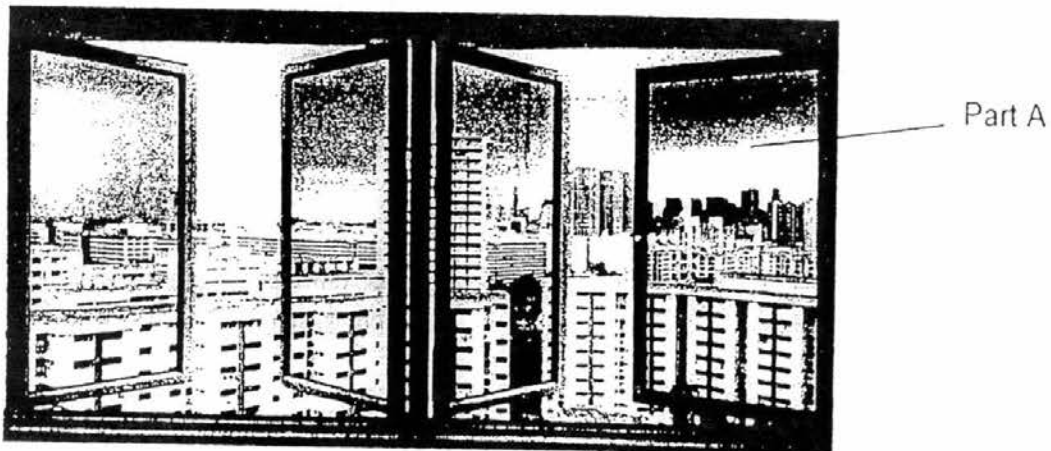

Based on the results in Mei Mei's experiment, which material will be most suitable to make Part A of the window?

- (1) W
- (2) X
- (3) Y
- (4) Z

- 4 Mike wanted to find out how the distance of magnet from iron filings affects the amount of iron filings attracted.

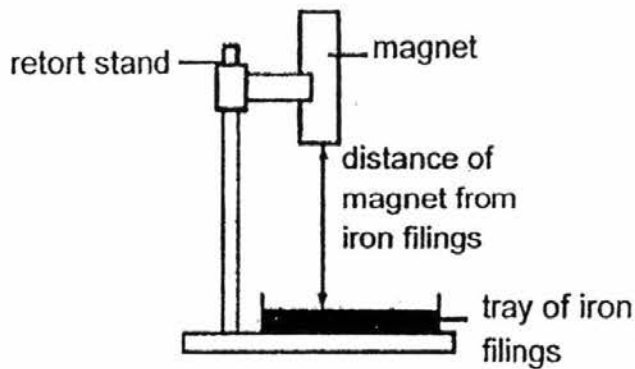

He set up the experiment as shown above. He measured and recorded the mass of the iron filings attracted to the magnet. He repeated his experiment several times by decreasing the distance between the magnet and the iron filings each time.

He plotted his results on a graph.

Which of the following graphs is most likely correct?

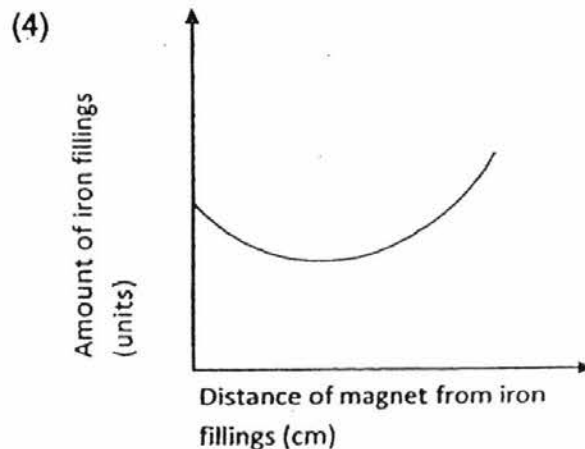
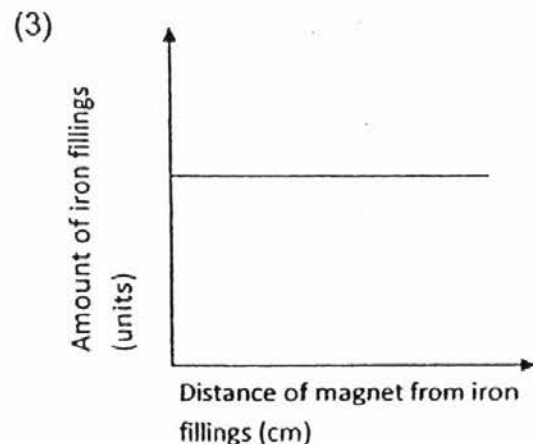
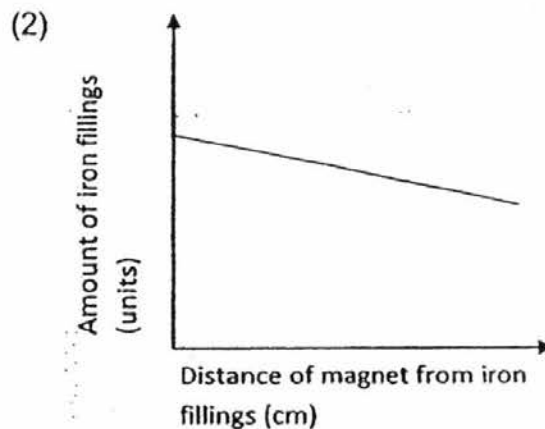
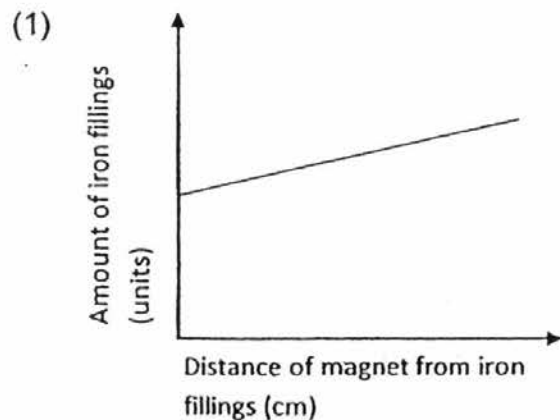

- 5 The diagram below shows the maximum number of paper clips that Magnets A, B, C and D attracted.

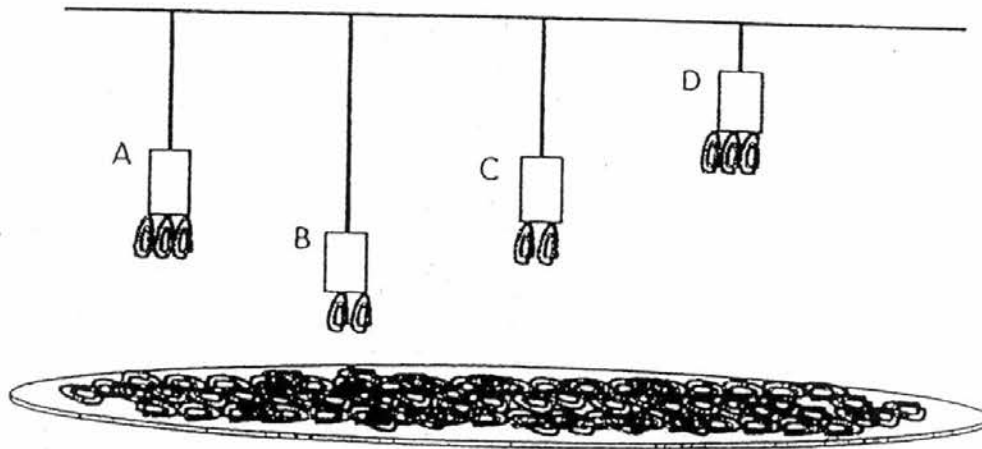

Which one of the following shows the correct order of magnets from the least magnetic strength to the greatest magnetic strength?

- (1) A, B, C, D
 - (2) B, C, A, D
 - (3) D, A, C, B
 - (4) D, C, A, B
- 6 The diagram below shows the life cycle of a beetle.

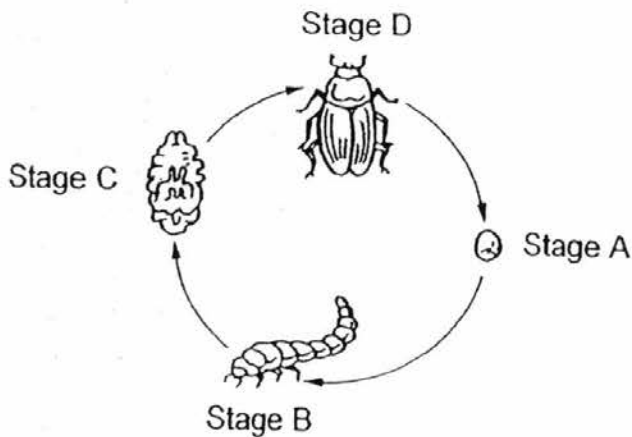

At which stage(s) of its life cycle does the beetle need to feed?

- (1) B only
- (2) A and C only
- (3) B and D only
- (4) A, C and D only

7 Pamela set up an experiment as shown below.

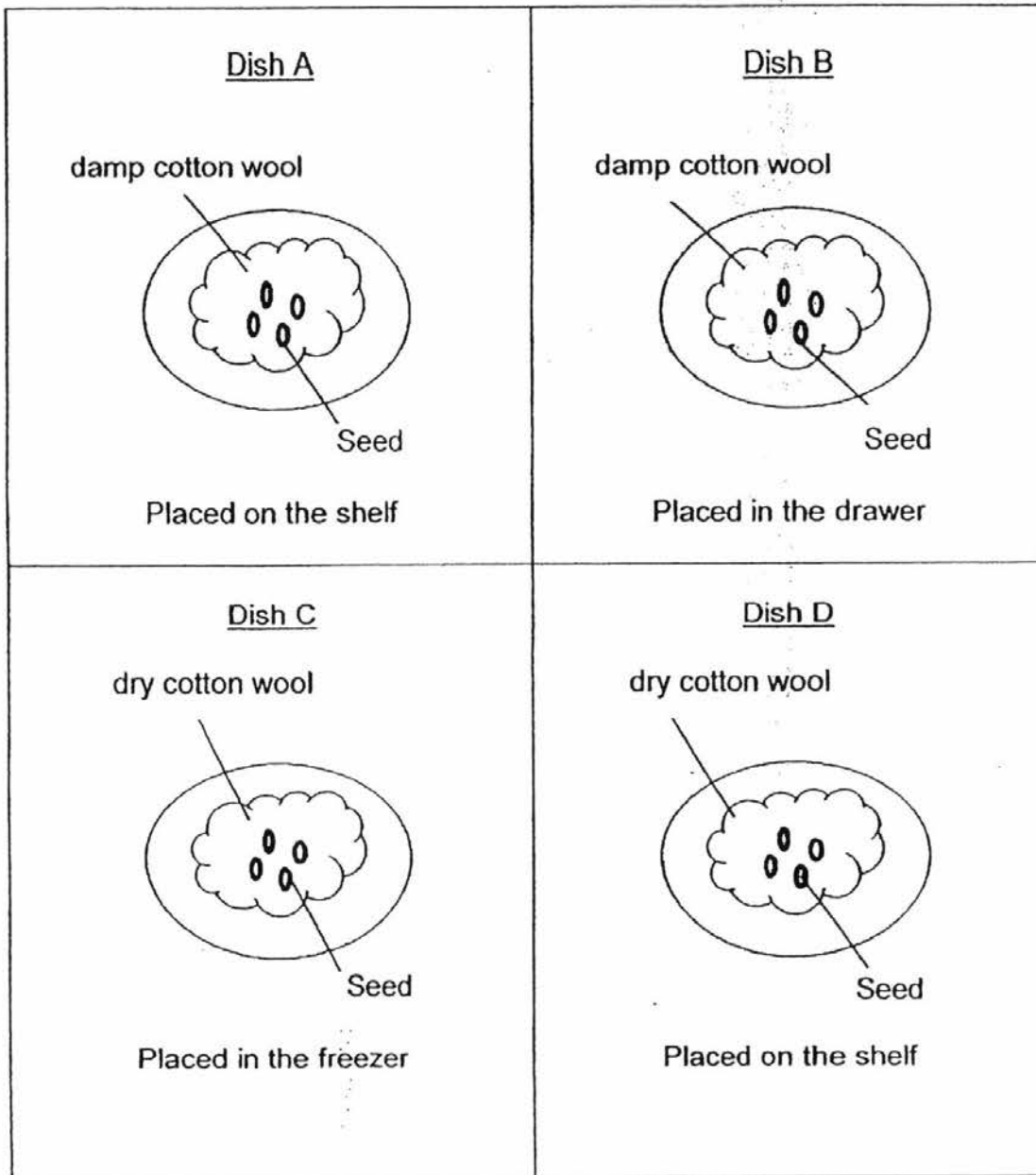

Which 2 dishes should Pamela use if she wanted to test if water is required for the germination of seed?

- (1) A and C
- (2) A and D
- (3) B and C
- (4) C and D

8 The diagram below shows a developing baby.



Which of the following statements are correct?

- A It develops from a fertilised egg.
 - B It does not need any food at this stage.
 - C It is developed inside the ovary of the mother.
 - D It takes about nine months to become fully developed.
- (1) A and C only
- (2) A and D only
- (3) B, C and D only
- (4) A, B and C only

9 Study the family tree below.

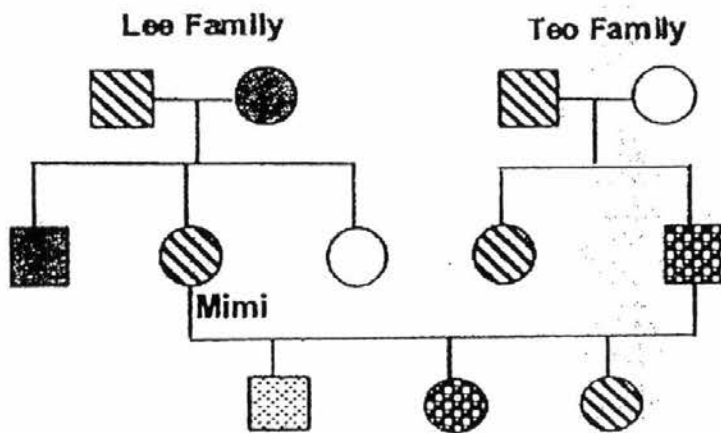

Key:	
	male
	female
	Brown eyes and no dimples
	Double eyelids and no dimples
	Brown eyes and has dimples
	Double eyelids and has dimples

Joshua Teo and Mimi Lee have a son, Li Ming.

Based on the family tree above, which of the following characteristics did Li Ming inherit from his parents?

- A Double eyelids
 - B Brown eyes
 - C Dimples
- (1) A only
- (2) C only
- (3) A and B only
- (4) B and C only

10 The diagram below shows the human reproductive systems.

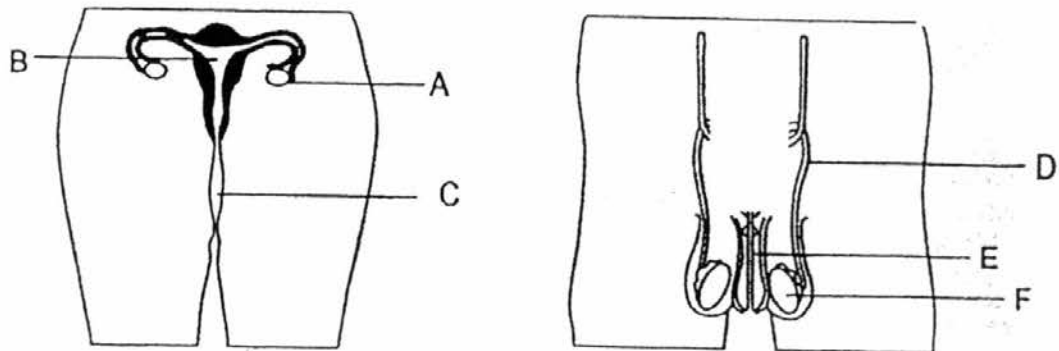

Which of the following is correct?

	Where the female reproductive cell is produced?	Where the male reproductive cell is produced?	Where the fertilised egg is developed?
(1)	A	D	C
(2)	A	F	B
(3)	C	E	B
(4)	B	F	A

11 Which of the following statements about human reproduction are true?

- A Many sperms are needed to fertilise one egg
- B The male produces sperms and the female produces eggs.
- C After fertilisation, the fertilised egg starts to divide to form more cells. ✓
- D Only characteristics that are observable physically can be inherited from parents to young.

- (1) A and B only
- (2) B and C only
- (3) A, B and C only
- (4) B, C and D only

- 12 Study the diagram below which shows the reproductive system of a female patient after she had undergone an operation. In this operation, the tube near the ovary was cut at X and tied.

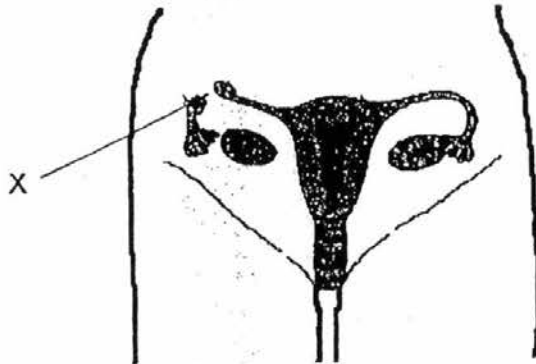

From the diagram, which of the following statements is most likely true as a result of this operation?

- (1) Fertilisation can still occur.
- (2) Egg cells will not be produced by the ovaries anymore.
- (3) No sperm cells are able to fuse with egg cells anymore.
- (4) Egg cells will not be released from the ovaries anymore.

- 13 The following diagram shows four processes in the sexual reproduction of a flowering plant.

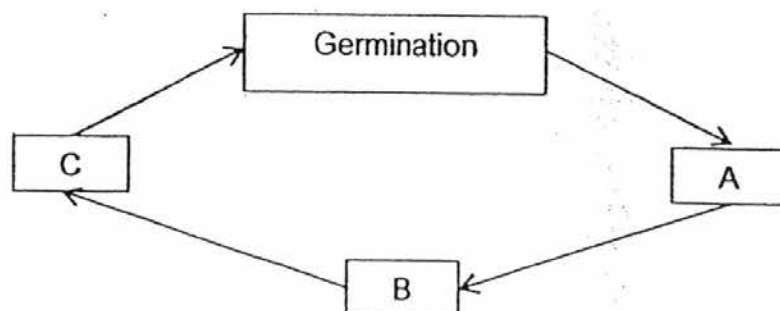

Which of the following shows the correct sequence of the processes?

	A	B	C
(1)	Dispersal	Pollination	Fertilization
(2)	Fertilization	Pollination	Dispersal
(3)	Dispersal	Fertilization	Pollination
(4)	Pollination	Fertilization	Dispersal

- 14 Li Shan observed a fruit and concluded that the seeds are dispersed by splitting. Which one of the following most likely describes the fruit she has observed?

- (1) The fruit has hair.
- (2) The fruit has hooks.
- (3) The fruit has a pod-like structure.
- (4) The fruit has a wing-like structure.

15 The diagrams below show the cross sections of two flowers from different plants.



Flower A

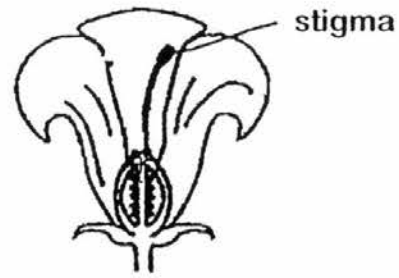

Flower B

What can you infer from the above diagrams?

- A Only Flower B requires pollinators.
- B Both Flower A and B can develop into a fruit.
- C Not all flowers have both male and female parts.
- D Both Flower A and B can undergo pollination.

- (1) A and B only
- (2) C and D only
- (3) A, B and C only
- (4) B, C and D only

16 An experiment was set up using 4 identical insect-pollinated flowers, A, B, C and D, in a field. Different parts of the flowers were removed as shown in the table below. Insects were observed to be visiting the flowers.

Flowers	Anthers	Stigma	Petals
A	Removed	Present	Removed
B	Present	Removed	Removed
C	Removed	Present	Present
D	Present	Removed	Present

Which flowers are most likely to develop into a fruit after two weeks?

- (1) A and B
- (2) A and C
- (3) B and D
- (4) C and D

- 17 Sue conducted an experiment on two identical fruits, P and Q, to investigate how temperature of each fruit affects the time taken for the fruits to split.

Which of the following type of results should Sue observe so that she could draw a conclusion to the experiment?

- A The surrounding temperature of the fruits.
- B The distance scattered by the fruits.
- C The time taken for the fruits to split.
- D The number of seeds that were not scattered

- (1) C only
- (2) B and C only
- (3) A, C and D only
- (4) B, C and D only

- 18 Which of the following statements about the rate of evaporation is/are true?

- A The higher the temperature of water, the faster it evaporates.
- B When there is more wind in the surrounding air, the rate of evaporation is higher
- C At room temperature, a liquid that has a lower boiling point than water evaporates more quickly than water.

- (1) A only
- (2) A and B only
- (3) A and C only
- (4) A, B and C

- 19 Pete poured an equal amount of water into four different containers as shown below. He left them in the open and observed the time taken for the water in the containers to dry up completely.

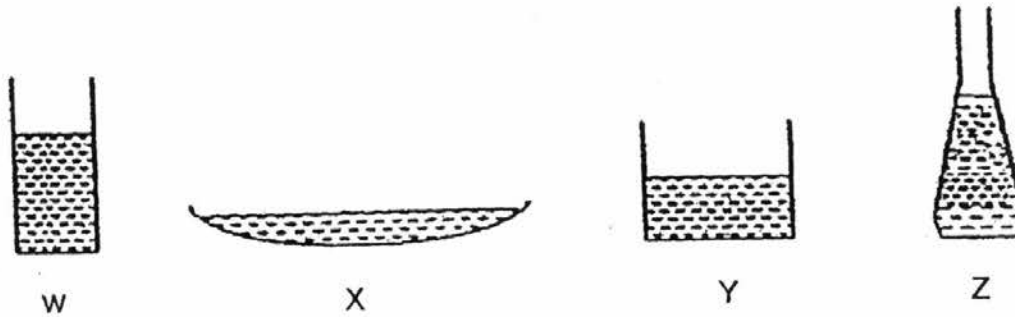

The table below shows the time taken for the water in containers W and Y to dry up completely.

Amount of time taken (hours):	
Container W	Container Y
10	6

Based on the information above, which of the following sets of results would most probably be the time taken (hours) for the water in containers X and Z to dry up completely?

	Container X	Container Z
(1)	3	8
(2)	14	12
(3)	8	12
(4)	3	14

20 The following diagram shows the changes of states of water.

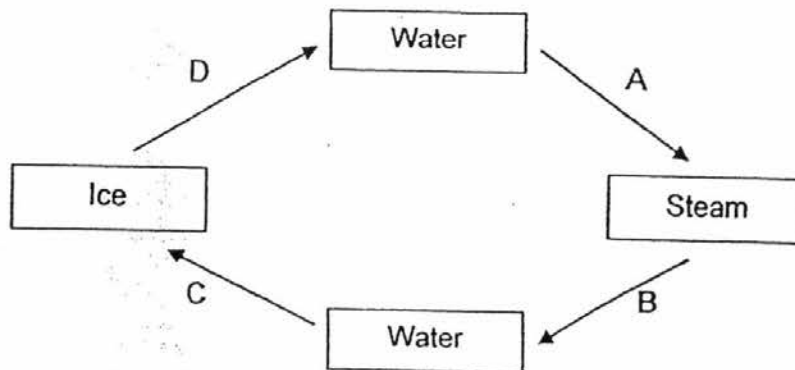

Which of the following processes (A, B, C or D) involves heat loss or heat gain?

	Heat loss	Heat gain
(1)	A and B	C and D
(2)	B and D	A and C
(3)	B and C	A and D
(4)	C and D	A and B

21 Lily wants to carry out an experiment to investigate how the amount of salt added to water affects its boiling point.

Which of the following variable(s) should be kept the same?

- A The source of water
- B The amount of salt
- C The volume of water
- D The boiling point of water

- (1) B only
- (2) D only
- (3) A and C only
- (4) A, B, C and D

22 The diagram below shows the water cycle.

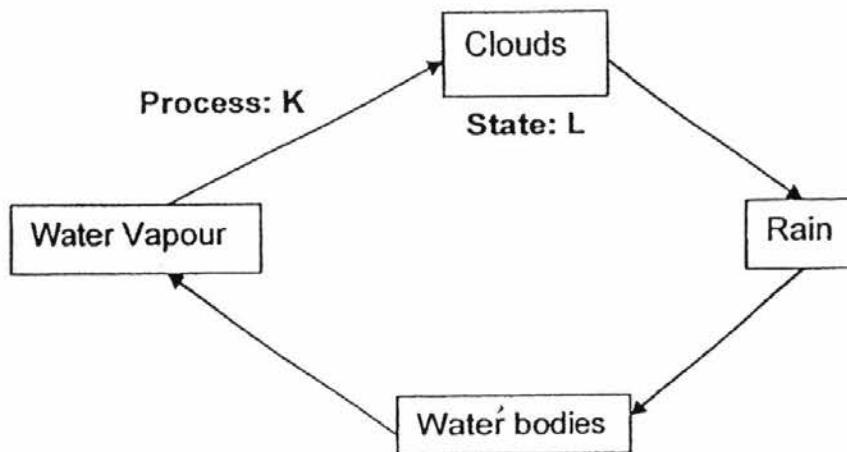

Which of the following is correct?

	K	L
(1)	Condensation	Liquid
(2)	Evaporation	Gas
(3)	Condensation	Gas
(4)	Evaporation	Liquid

23 The table below shows the boiling and freezing points of 3 substances, X, Y and Z.

	X	Y	Z
Boiling Point (°C)	19	110	72
Freezing Point (°C)	5	38	13

What is the state of the substances, X, Y and Z, at room temperature of 26°C?

	X	Y	Z
(1)	gas	liquid	solid
(2)	liquid	solid	gas
(3)	gas	solid	liquid
(4)	solid	gas	liquid

24 The diagrams below show the different stages of the water cycle.

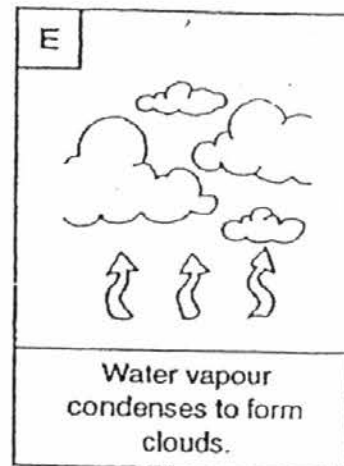
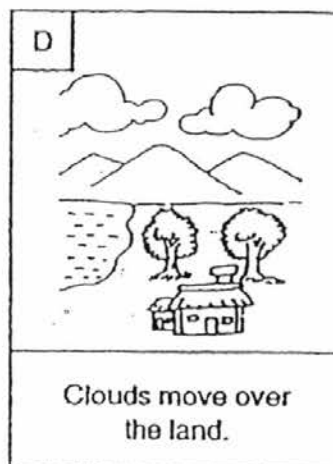
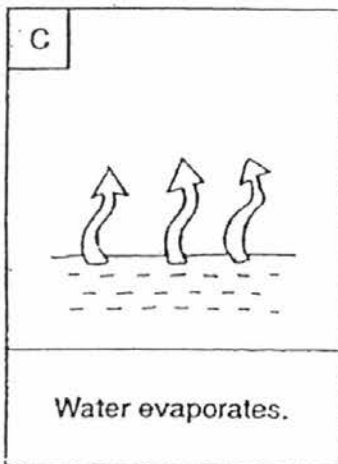
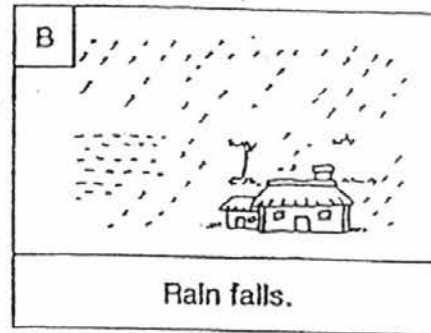
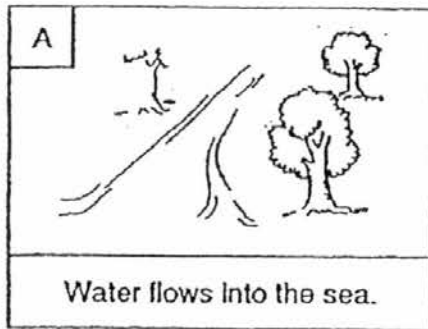

Arrange the stages of the water cycle in the correct order, starting from Stage B.

B, _____, _____, _____, _____

- (1) A, C, E, D
- (2) D, E, A, C
- (3) D, E, C, A
- (4) A, E, C, D

25 Hana puts an ice cube on a plate. After a while, the ice cube starts to melt. She writes down the following reasons for her observation.

- A The ice cube loses heat to the plate.
- B The ice cube loses heat to its surroundings.
- C The plate takes away heat from the ice cube.
- D The ice cube takes in heat from its surroundings.

Which of the reason(s) is/are correct?

- (1) B only
- (2) D only
- (3) A and C only
- (4) A and D only

26 Study the two diagrams below.

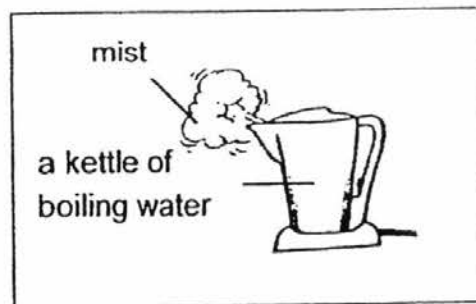
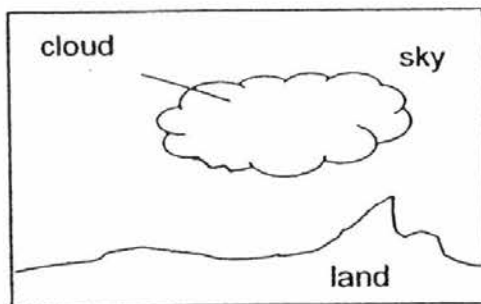

Which two statements describe the similarity between how are the clouds in the sky and the mist formed around the spout of a kettle of boiling water?

- A Both are made up of water vapour..
 - B Both are made up of water droplets..
 - C Both are caused by losing heat to the surrounding.
 - D Both are formed by the evaporation of water.
-
- (1) A and C
 - (2) A and D
 - (3) B and C
 - (4) B and D

27 Which one of the following activities helps to conserve water?

- (1) Using a hose to wash car.
- (2) Rinsing one's mouth under running water.
- (3) Leaving the tap on when washing your hands with soap.
- (4) Reuse water for washing clothes to wash the bathrooms.

28 The amount of _____ in the surrounding air is the cause of the change in the state of rain into chunks of ice as it falls to the ground.

- (1) gas
- (2) heat
- (3) clouds
- (4) water vapour



PEI HWA PRESBYTERIAN PRIMARY SCHOOL
SEMESTRAL ASSESSMENT 1

**PRIMARY 5
SCIENCE**
13th May 2016
(BOOKLET B)

Name: _____ ()

Class: Primary 5 Loyalty _____

Total time: 1 hour 45 minutes

INSTRUCTIONS TO CANDIDATES

1. Write your Name, Class and Index No. at the spaces provided above.
2. DO NOT turn over the page until you are told to do so.
3. Follow all instructions carefully.
4. Answer all questions.
5. Write all your answers in this booklet.

FOR TEACHER'S USE

Marks (Booklet A) :	56
Marks (Booklet B) :	44
Total Marks (Booklet A & B) :	100

There are a total of 15 pages in this booklet, excluding the cover page.

For questions 29 to 41, write your answers in the booklet.

The number of marks available is shown in brackets [] at the end of each question or part question. (44 marks)

- 29 Mary conducted an experiment on a chick. The jar was then covered with a plastic wrap and many holes were made on it. Mary added seeds into the jar and refilled the water every day.

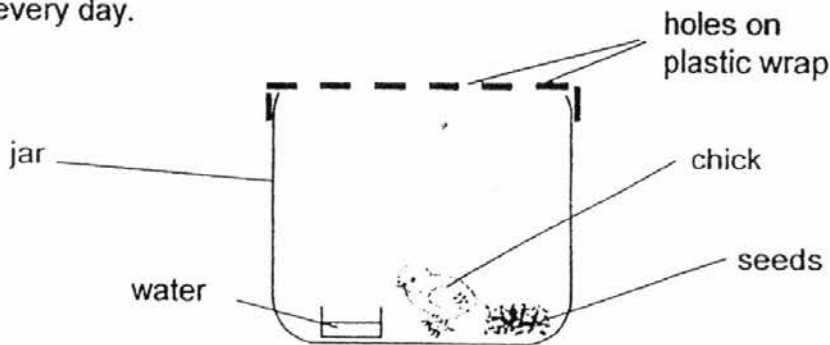

- (a) What was the purpose of the holes on the plastic wrap? [1]

- (b) Then, Mary forgot to put any seeds in the jar for two weeks. She noticed that the chick had died. Explain her observation. [1]

30 The table below shows animals that are classified into 4 groups, A, B, C and D.

Group A	Group B	Group C	Group D
Angelfish	Beetle	Owl	Whale
Guppy	Ant	Rooster	Bat

(a) State the animal groups for the animals in Group A and Group C. [1]

Group A: _____

Group C: _____

(b) State one similarity in the method of reproduction of the animals in Group B and Group C. [1]

31 Diagram A below shows a 50 ml beaker filled with 40ml of water.

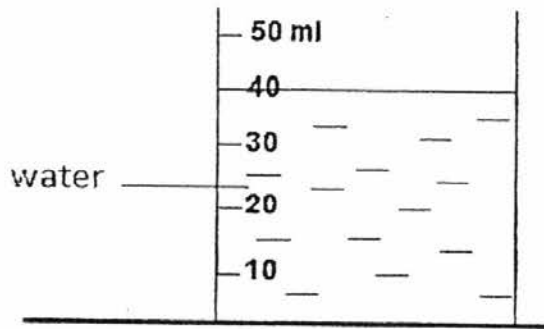

Diagram A.

(a) Ali put in 2 marbles of 5 cm^3 each into the beaker.

Draw the new water level on Diagram B below

[1]

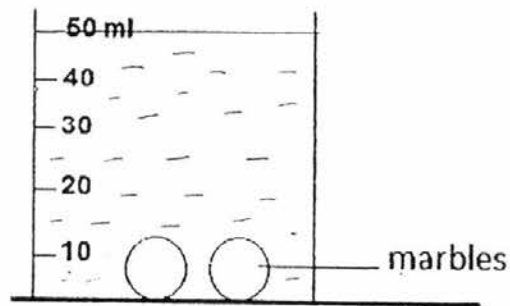

Diagram B

(b) (i) Ali decided to put another 5 more marbles of the same volume into the beaker in Diagram B. Describe what he would observe.

[1]

(ii) Explain Ali's observation in (b)(i).

[1]

- 32 Han Han conducted an experiment as shown below. He used 2 cups made of different materials, Cup A and Cup B. He filled Cup A and Cup B with the same amount of hot water. After that, he connected two temperature sensors to a computer to measure the changes in the temperature of the hot water in Cup A and Cup B.

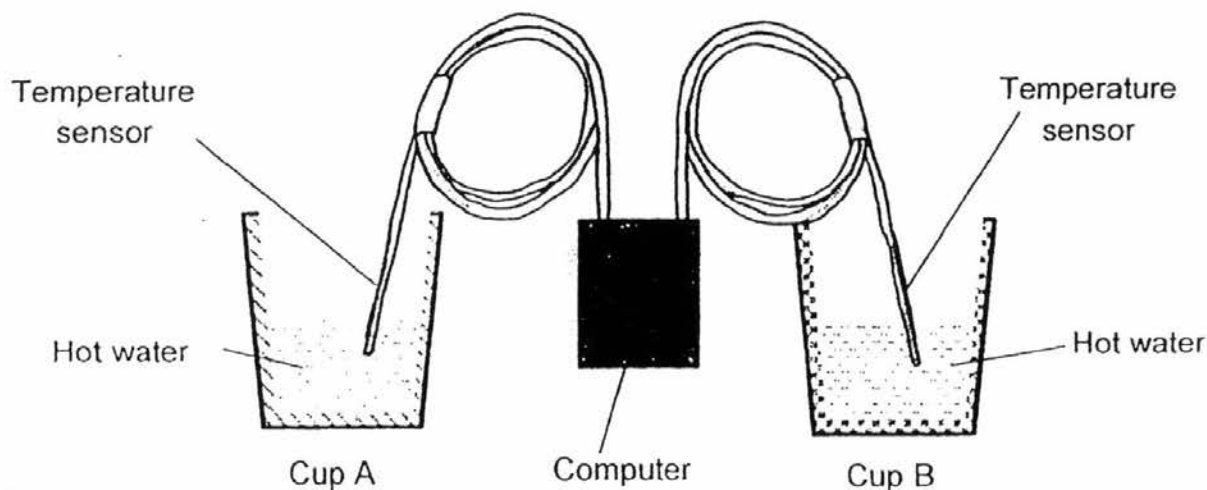

The computer displayed the results as shown below.

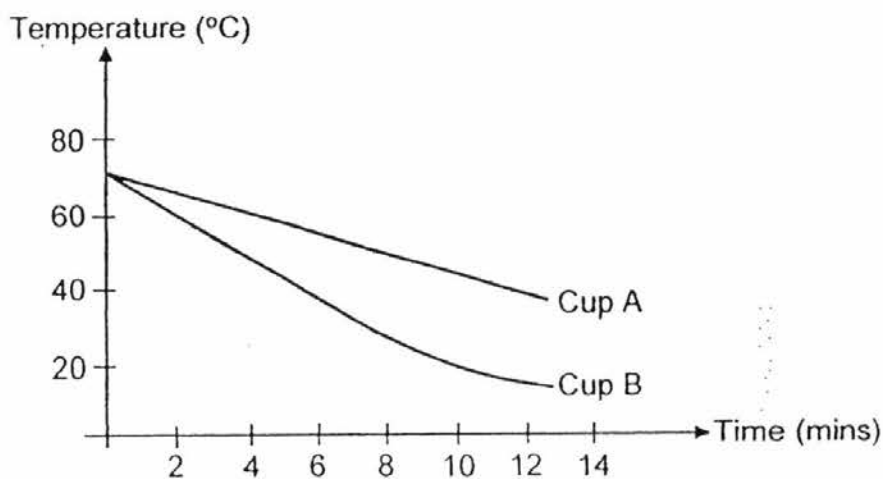

- (a) Based on the information in the graph, which cup, A or B, should Han Han use to keep his iced water cold for a longer period of time?
Explain your answer. [2]

Question 32b continues on page 23

- (b) Explain what will happen to the temperature of the water in cup B if all the water from cup A is added to cup B at the 12th minute. [1]

- 33 The picture below shows a honey bee collecting nectar from a flower.



- (a) Explain how the nectar helps in the pollination of flowering plants. [2]

- (b) Besides nectar, state two characteristics insect-pollinated flowers have to attract the insects to the flower. [1]

- 34 Albert wanted to find out which fruit colour will increase the chance of the fruit being dispersed by the bird.

He set up the experiment using a circular box with 4 trap doors of different colours. Behind each trap door contained the same amount of food that the bird eats. He placed the bird in the centre and every time the bird had visited a trap door, he would move the bird to the centre again. He counted the number of times the bird visited each trap door for one hour.

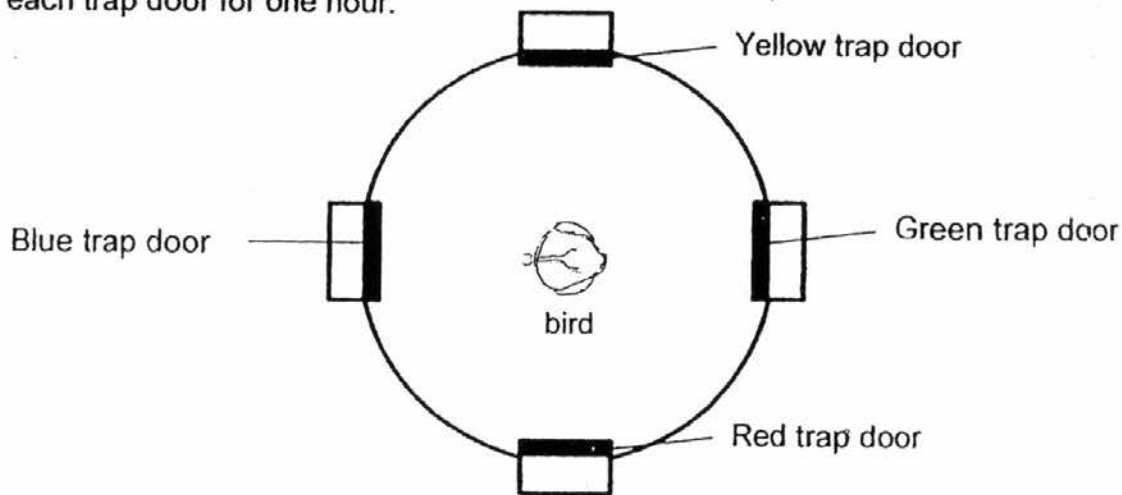

He recorded his results in the table below.

Colour of trap door	Number of visit to each trap door			
	1 st	2 nd	3 rd	Average
Yellow	24	23	22	23
Green	3	1	2	2
Red	30	24	26	30
Blue	6	8	7	7

- (a) Based on his results, what can he conclude about his experiment? [1]

- (b) Why did Albert repeat his experiment? [1]

- (c) How does placing the bird in the centre ensure that the experiment is fair? [1]

- 35 Warren used two kettles of the same material, size and shape to boil same amount of water. Kettle A took a longer time to boil the water than Kettle B. When he checked the heating coil of the two kettles, he found that although they are made of similar materials, they were placed differently in the two kettles.

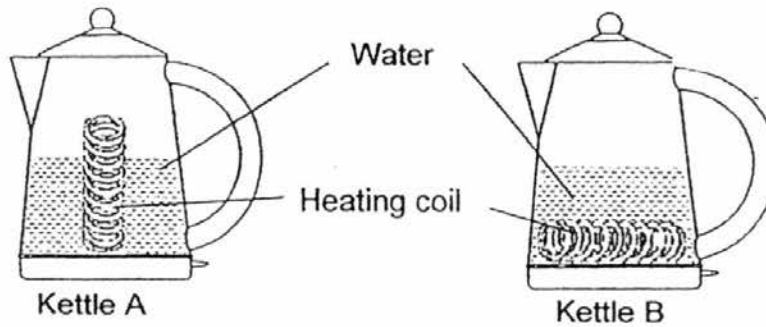

- (a) Explain why it took a shorter time for the water in Kettle B to boil. [1]

Eli bought two similar-sized hot coffee. He found that although the two cups were made of the same material, the surface of the cup E was smooth but the surface of cup F had grooves on it.

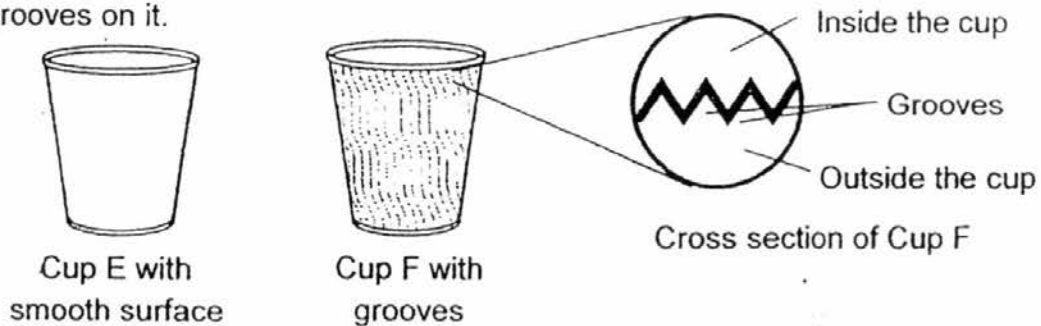

He also realised that Cup F felt less hot even though the temperature of coffee in both the cups were the same.

- (b) Explain why it felt less hot to hold Cup F. [1]

- (c) State one property of the material that both paper cups must have in order for a person to be able to hold hot beverages without getting burned. [1]

- 36 Ben carried out an experiment to find out how long it will take for his jeans to dry after washing.

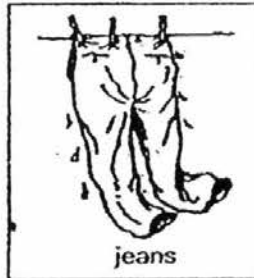

He weighed his jeans immediately after washing. Then, he hanged it on a clothes line. Ben weighed his jeans every 15 minutes and recorded the mass in the table below.

Time (min)	Mass of jeans (g)
0	850
15	600
30	520
45	480
60	420
75	420
90	420

- (a) How long did the jeans take to dry? [1]

- (b) Based on the table above, how would he know that his jeans have completely dried? [1]

- (c) Besides hanging the jeans under the hot sun, state another environmental factors that would speed up the drying of Ben's jeans. [1]

- 37 (a) In the diagram below, label the reproductive parts of the male reproductive system in the boxes below. [2]

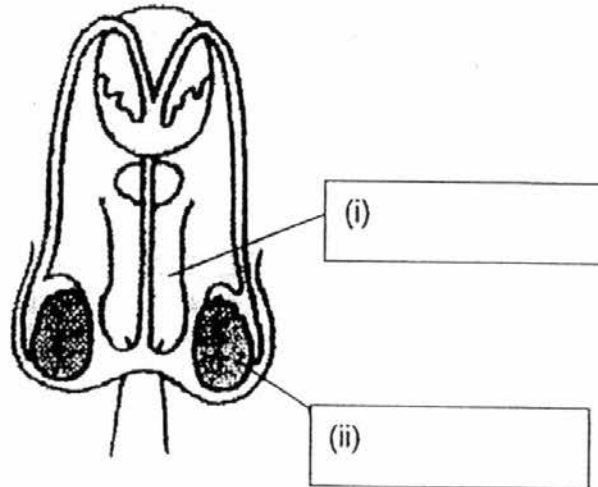

- (b) If only one sperm is needed for fertilisation to occur, give a reason why millions of sperms are produced. [1]

- (c) The diagram below show the female human reproductive system.

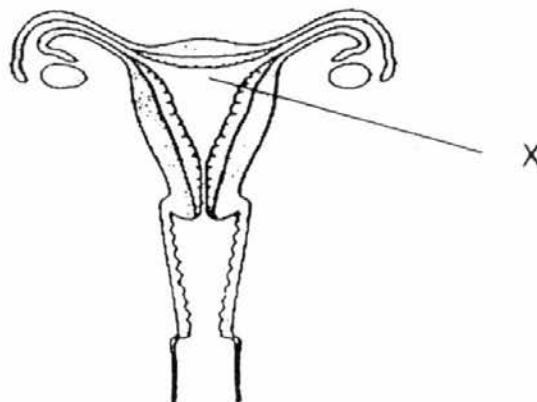

female human reproductive system

- Identify and state the function of Part X in the diagram below. [1]

38 Susan investigated the germination of pea seeds. She set up three test tubes, A, B and C, as shown in the diagram below. She left them for ten days in a warm environment.

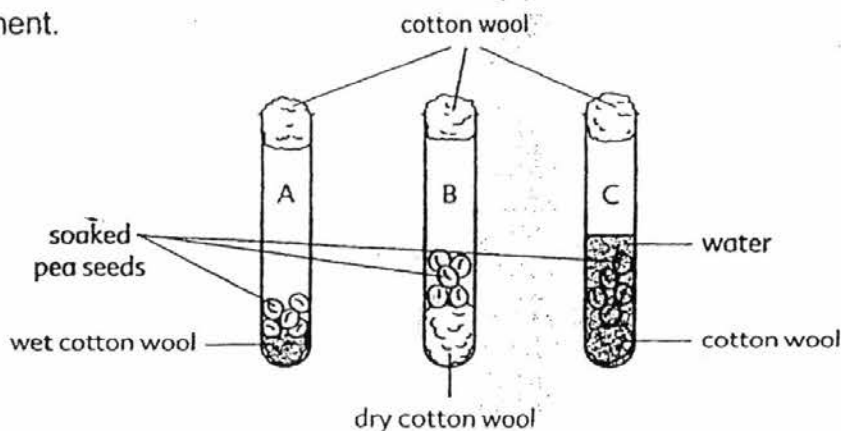

After ten days, the results were as follows:

Test tube	Observation
A	The seeds germinated and developed into a young plant.
B	The seeds started to germinate but did not develop into a young plant.
C	The seeds did not germinate at all.

(a) Why did the seeds in test tube B start to germinate but did not develop into a young plant? [2]

(b) Why did the seeds in test tube C not germinate at all? [1]

Question 38c continues on page 29

- (c) Susan then set up another test tube D and replaced the cotton wool with a rubber stopper as shown below.

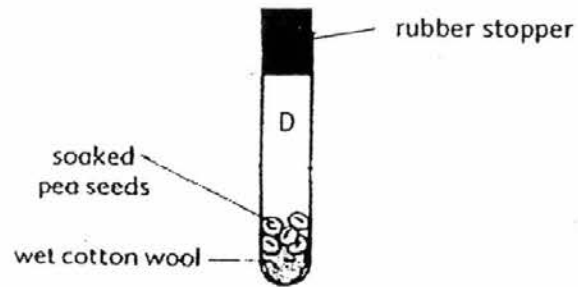

She found that the seeds in test tube D took a longer time to germinate when compared to the seeds in test tube A. Explain why. [1]

- 39 A mixture of sand, salt and water was heated as shown below. The mixture was brought to a boil. After a few minutes, liquid X was formed on the underside of the glass sheet.

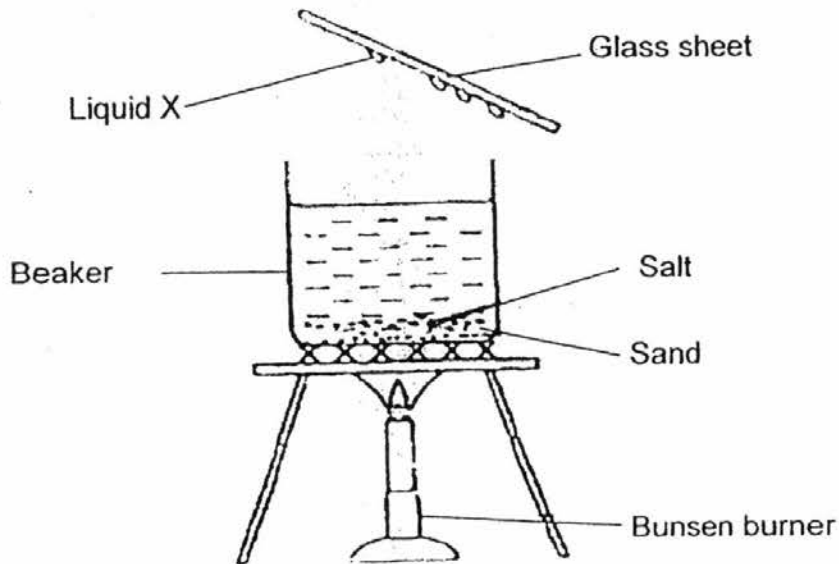

- (a) Tick (✓) the box(es) that describes liquid X. [1]

- colourless
 tastes salty
 feels sandy

- (b) Explain how liquid X was formed. [2]

- (c) After a while, less condensation took place on the glass sheet, even though the mixture in the beaker was still boiling. Explain why this is so. [1]

40 Tommy was studying a cross-section of flower P as shown below.

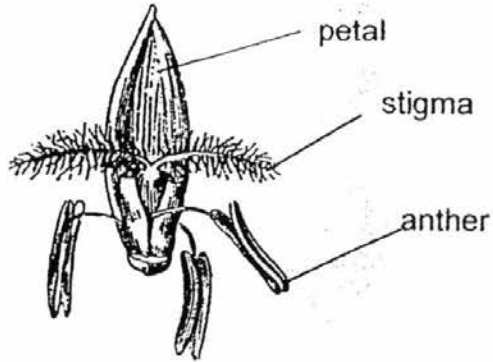

Flower P

(a) Based on the picture above, his friend, Nora, says that the flower is pollinated by wind.

Give 2 reasons why Nora is correct.

[2]

- (i) _____

- (ii) _____

(b) The diagram below shows 2 similar flower P, still attached to the plant, but with different reproductive parts removed.



Flower P1



Flower P2

Which flower(s) cannot become a fruit? Give a reason for your answer.

[1]

Question 40c continues from page 32

- 40 (c) The diagrams below show 2 fruits, Fruit P and Fruit Q, from a tree P and tree Q respectively. They are dispersed by wind. (Measurements are not drawn to scale).

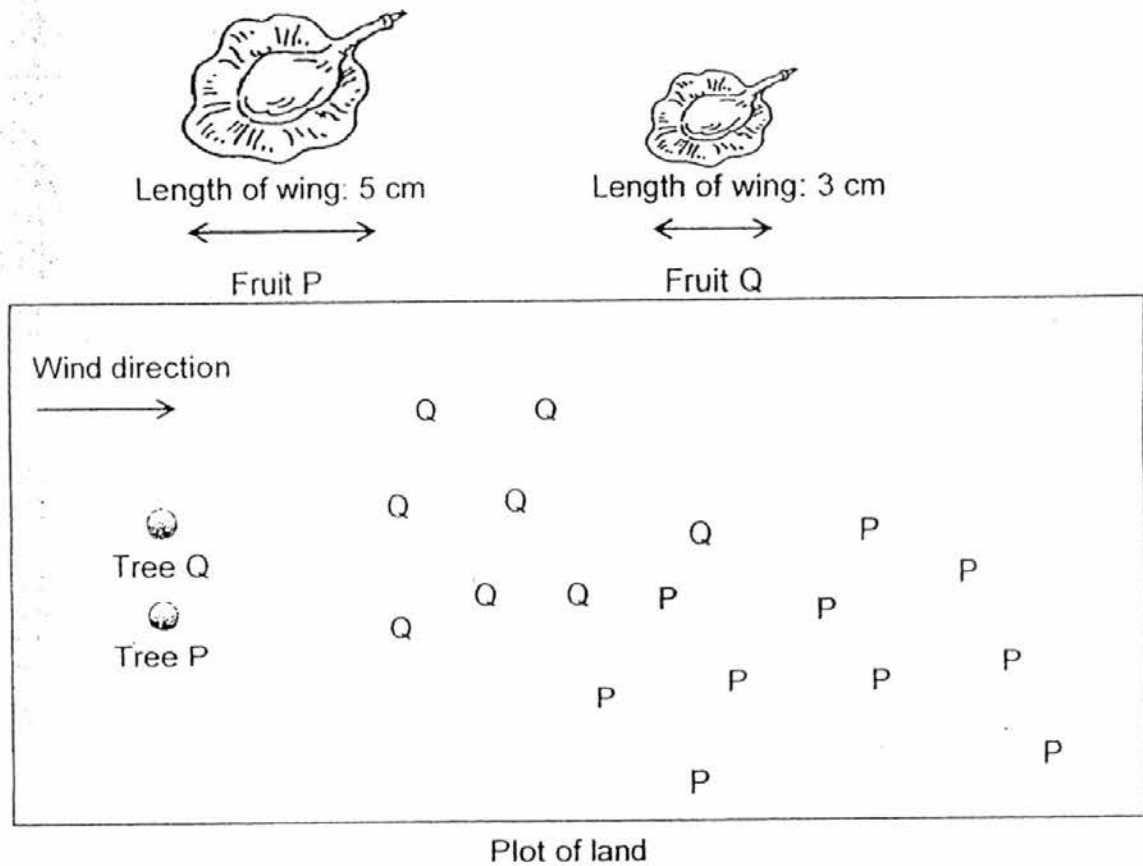

- (i) Based on the information above, what is the relationship between the length of the wing of the fruit and the distance the fruit is dispersed by the wind? [1]

- (ii) Explain why P travelled further than Q. [1]

- 41 The set-ups below show two similar beakers A and B containing equal amount of water placed in rooms of different surrounding temperatures.

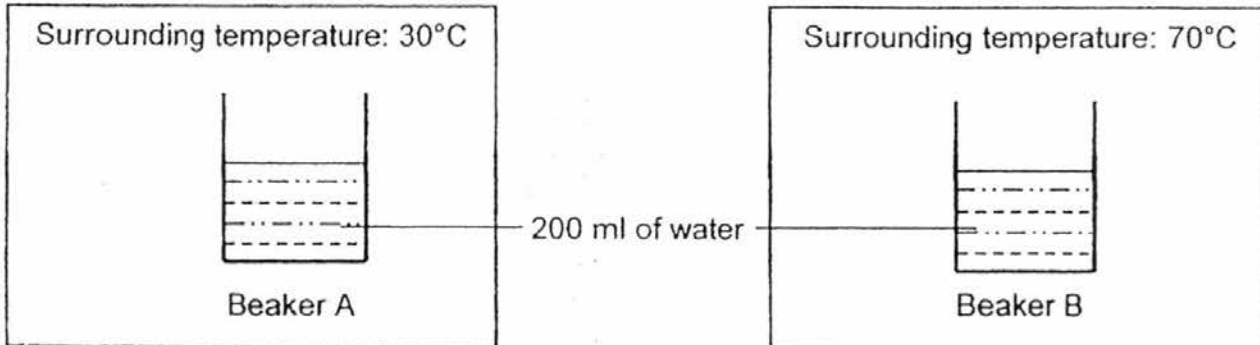

- (a) What is another variable that must be kept the same in order for the experiment to be fair? [1]

- (b) Which beaker, A or B, will have less water left after 2 hours? Explain your answer. [2]

- (c) Bala had two glasses of cold water from the refrigerator and left it on the table. He knew one of the glasses contained water that was colder than the other glass. **Without using the sense of touch or a thermometer**, describe what Bala should do to find out which glass contained the colder water. [2]

-- END OF PAPER --

YEAR : 2016
 LEVEL : PRIMARY 5
 SCHOOL : PEI HWA PRESBYTERIAN PRIMARY
 SUBJECT : SCIENCE
 TERM : SA1

Booklet A

Q1	2	Q5	2	Q9	2	Q13	4	Q17	1	Q21	3	Q25	2
Q2	4	Q6	3	Q10	2	Q14	3	Q18	4	Q22	1	Q26	3
Q3	2	Q7	2	Q11	2	Q15	4	Q19	4	Q23	3	Q27	4
Q4	2	Q8	2	Q12	1	Q16	2	Q20	3	Q24	1	Q28	2

Booklet B

- Q29a To allow air to enter for the chick to breathe.
- Q29b Living things need air, food and water to survive. As the chick did not have any food to eat, it was unable to survive.
- Q30a Group A: Fish
Group C: Birds
- Q30b Both animals in Group B and C lay eggs.

Q31a

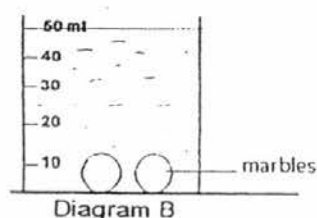

- Q31b (i) The water will overflow.
(ii) The marbles occupy the space of the water.
- Q32a Cup A. It is a poorer conductor than material B so it will gain heat from the surroundings more slowly.
- Q32b The temperature of water in cup B will rise as it gains heat from the water in cup A.

- Q33a The nectar is a source of food for insects and insects will get attracted by it. The insects brush past the anthers, pollen grains will stick to its body and will be transferred to a stigma of a female flower.
- Q33b They have colourful petals and a pleasant smell to attract the insects.
- Q34a Red was the best colour to increase the chance of the fruit being dispersed by the bird.
- Q34b To ensure that his results are reliable.
- Q34c This is to ensure that the distance of the bird to each trap door is the same.
- Q35a Coil B which is arranged horizontally is fully immersed in the water allowing a larger surface area to be in contact with the water to allow more heat to move from the coil to the water than coil A.
- Q35b Cup F has grooves that has air spaces and air is a poor conductor of heat so it slows down the heat gained.
- Q35c They must be poor conductors of heat.
- Q36a 60 minutes
- Q36b From 60 to 90 minutes, the mass of the jeans remained the same.
- Q36c Hang it at a windy place.
- Q37a (i) Penis
(ii) Testes
- Q37b It increases the chances of fertilising the egg.
- Q37c Womb. It is to protect the developing baby.
- Q38a The soaked seeds had water to germinate at first but there was not enough for the seeds to continue growing.
- Q38b There was too much water in test tube C and there was no oxygen resulting the seeds to be unable to breathe and germinate.
- Q38c The rubber stopper prevented air to enter so the seeds did not receive enough air.

- Q39a ✓ colourless
- Q39b The steam from the boiling water came into contact with the cooler underside surface of the glass sheet, lost heat and condenses into tiny water droplets.
- Q39c The glass sheet started to gain heat and steam from the boiling water was unable to condense on the underside of the glass sheet.
- Q40a (i) It has feathery stigmas hanging out.
(ii) The anthers are hanging out.
- Q40b Both flowers cannot become a fruit, both flowers have their stigmas removal, thus pollen grains are unable to reach the ovaries for the flower to become a fruit.
- Q40c (i) The longer the length of the wing of the fruit, the further the distance the fruit is dispersed by the wind.
(ii) A longer wing will allow the fruit to stay for a longer time in the air and be carried further away.
- Q41a The temperature of the water.
- Q41b B. Because the surrounding temperature is higher so more heat is gained by the water, so more evaporation takes place.
- Q41c Put both glasses at room temperature in the same environment. Then measure amount of water droplets, more droplets is colder water.

End