



NAN HUA PRIMARY SCHOOL
SEMESTRAL ASSESSMENT 2
PRIMARY FIVE
SCIENCE

Name : _____

Class : Primary 5 / _____

Date : 28 October 2008 -

Duration : 1 hr 45 min

MARKS	
Sect A:	/ 60
Sect B:	/ 40
Total :	/ 100

Parent's Signature : _____

Section A: (30 x 2marks = 60marks)

For each question from 1 to 30, four options are given. One of them is the correct answer. Make your choice (1, 2, 3 or 4). Shade the correct oval (1, 2, 3 or 4) on the Optical Answer Sheet.

1. A plant cell has a _____ but an animal cell does not.
- | | |
|---------------|-------------------|
| (1) cell wall | (2) cytoplasm |
| (3) nucleus | (4) cell membrane |

2. Which of the following statements about reproduction in living things is/are correct?

- (A) All organisms reproduce by sexual reproduction.
(B) Reproduction is a way to prevent the extinction of a species.
(C) In human beings, the ovaries in the female reproductive system release the eggs and the testes in the male reproductive system produce the sperms.

- | | |
|------------------|------------------|
| (1) B only | (2) A and C only |
| (3) B and C only | (4) A, B and C |

3. The flowchart below shows some objects in the Solar System.

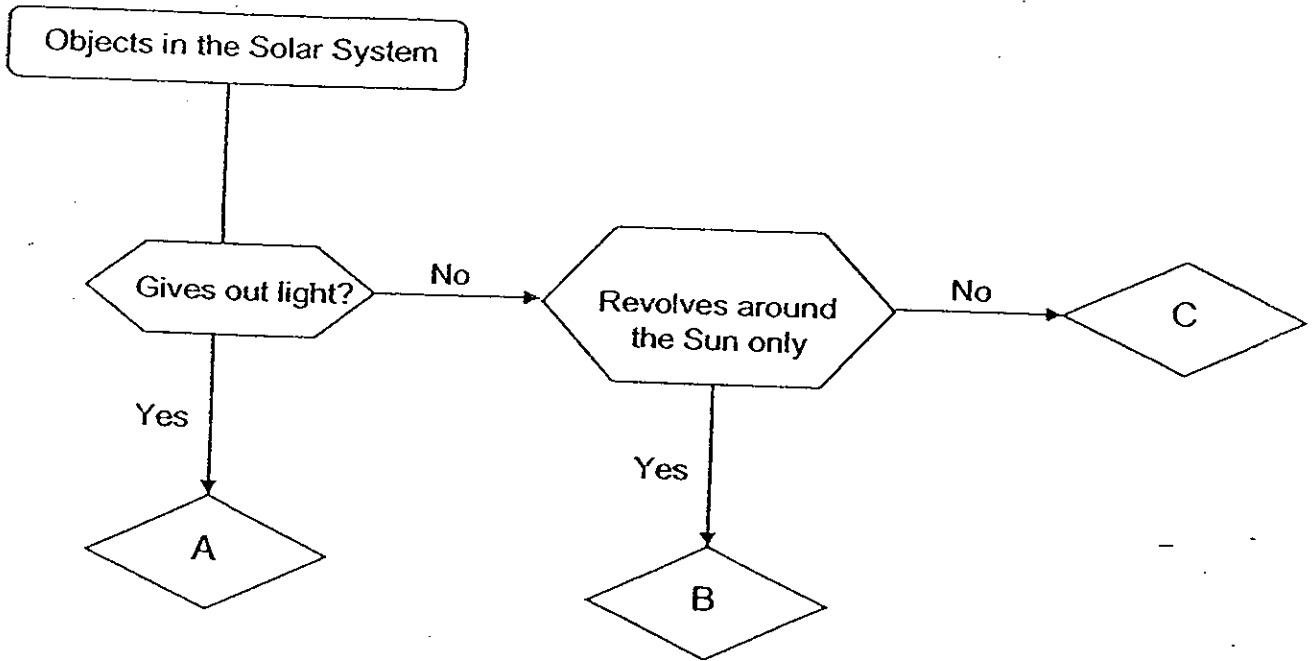

What do objects A, B and C represent ?

	A	B	C
(1)	Star	Moon	Earth
(2)	Earth	Star	Moon
(3)	Moon	Star	Earth
(4)	Sun	Earth	Moon

4. The diagram below shows the cross section of a flower.

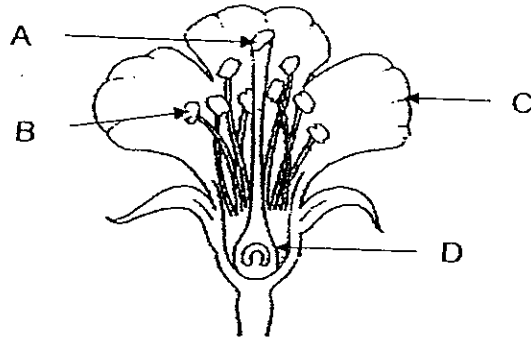

Which part of the flower would develop into a fruit after fertilization?

- (1) A
- (2) B
- (3) C
- (4) D

5. Three new batteries each 1.5V are arranged in four different ways to light up a 2.5V bulb as shown in the diagrams below. Which one of the arrangements will result in the brightest light from the bulb?

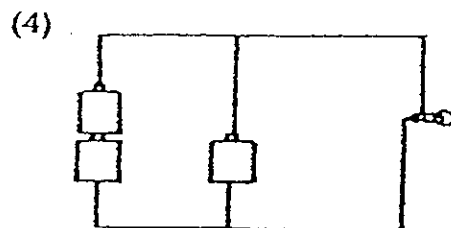
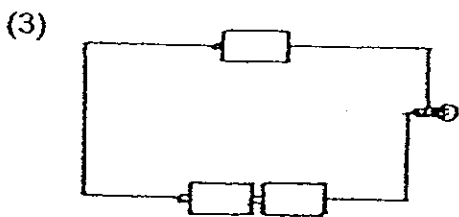
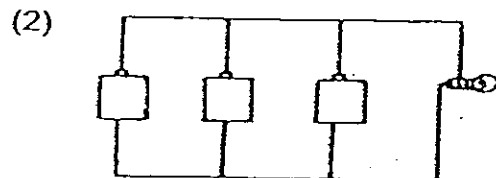
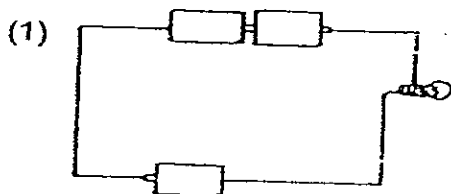

6. The graphic organizer shown below makes four comparisons between respiration and photosynthesis.

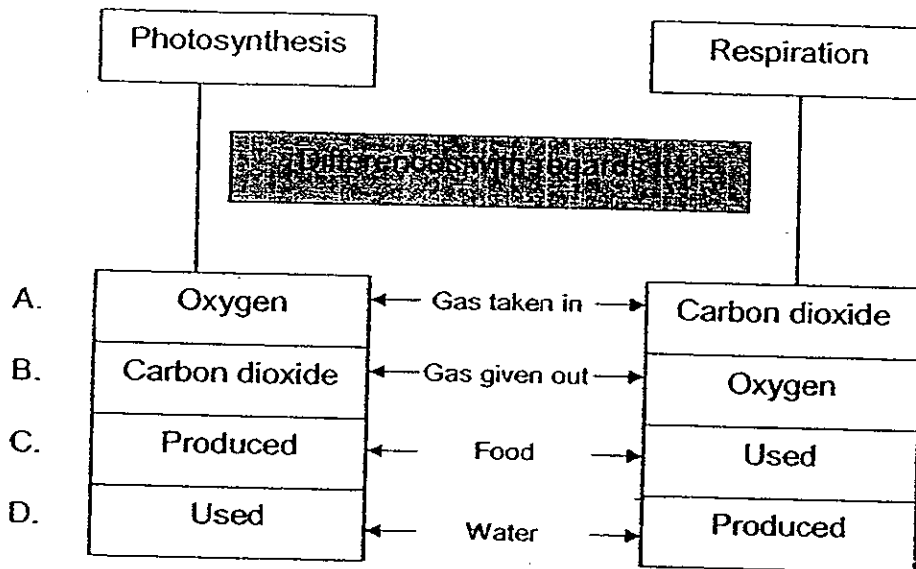

Which of the above comparisons is incorrect?

- (1) A and B only
- (2) B and C only
- (3) A, B and C only
- (4) A, B and D only

7. Mary left four set-ups in a sunny place as shown below. Which one of the set-ups would collect the **greatest** amount of oxygen in the test tube after a few hours?

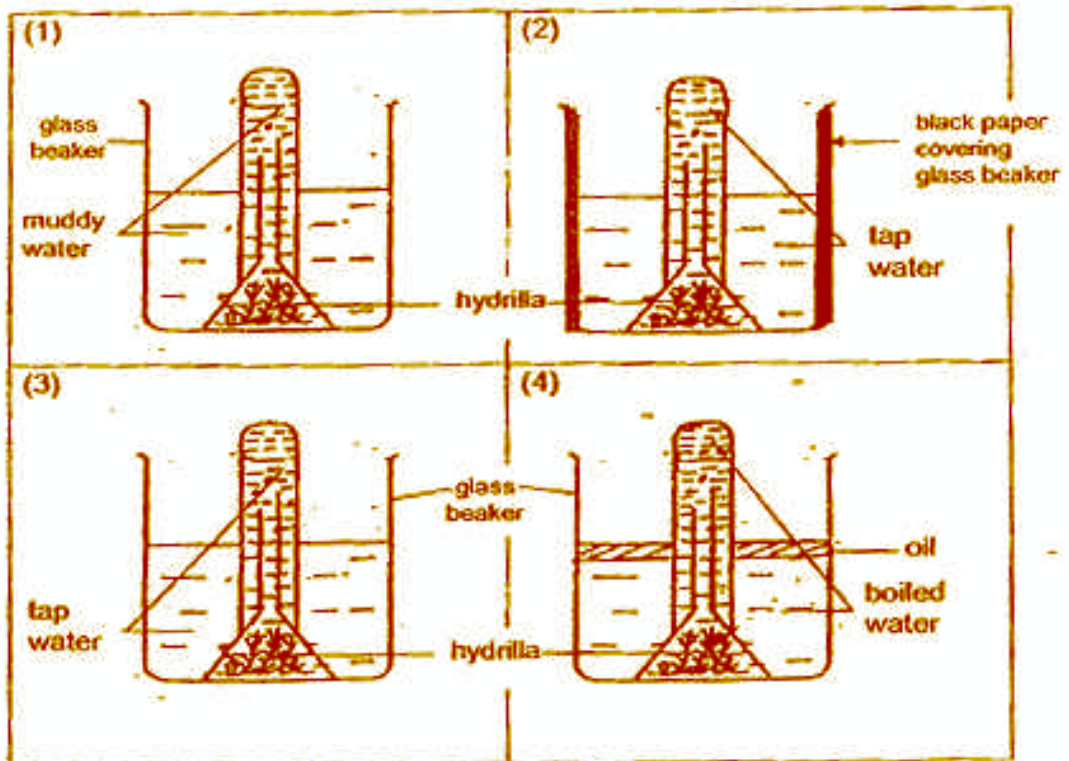

8. Which one of the following correctly shows the order of the different stages in the life cycle of a flowering plant?

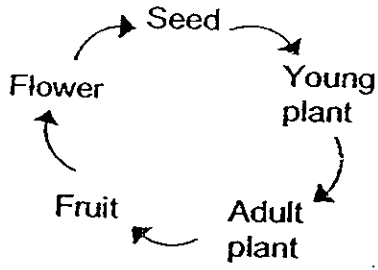

(1)

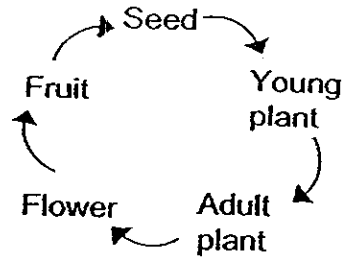

(2)

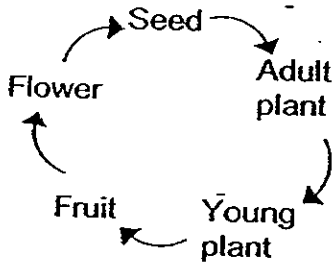

(3)

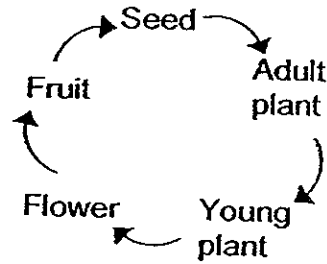

(4)

9. Study the diagram of a plant below.



Which one of the following correctly shows the characteristics of the plant?

- (A) It has a woody stem.
- (B) It is a flowering plant.
- (C) It has toothed-edge leaves.

- (1) A and B only
- (3) B only

- (2) A and C only
- (4) A, B and C

10. Samantha ate a sandwich during recess.
Which one of the following shows the correct route the sandwich will take in the digestive system?

- (1) Mouth → Gullet → Stomach → Large Intestine → Small Intestine
- (2) Mouth → Gullet → Stomach → Small Intestine → Large Intestine
- (3) Mouth → Stomach → Large Intestine → Small Intestine
- (4) Mouth → Small Intestine → Stomach → Large Intestine

11. Shirley observed the shadow of a flagpole and noticed that it is formed on one side of the flagpole in the morning, and on other side in the evening.

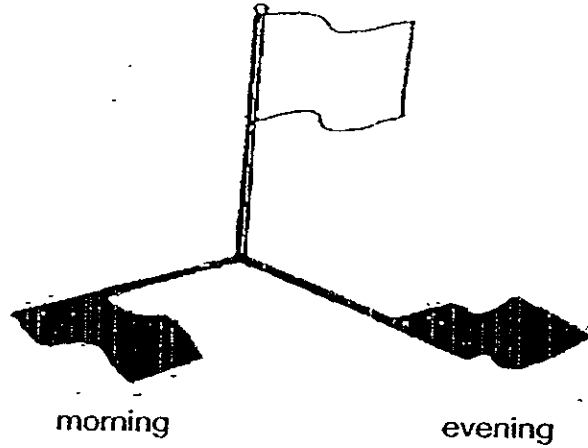

The change is a result of the _____

- (1) rotation of the Moon
 - (2) rotation of the Earth about its axis
 - (3) revolution of the Earth around the Sun
 - (4) revolution of the Sun around the Earth
12. A bacteria cell divides itself into two daughter cells in 10 minutes. How many daughter cells will there be after 50 minutes?
- (1) 8
 - (2) 16
 - (3) 32
 - (4) 64

15. Which of the following plants can be grown from underground stems?

- (A) Onion
- (B) Potato
- (C) Pineapple
- (D) Sweet potato

- (1) A and B only
- (2) A and C only
- (3) B and D only
- (4) A, B and D only

16. Which of the following tools are used as levers?

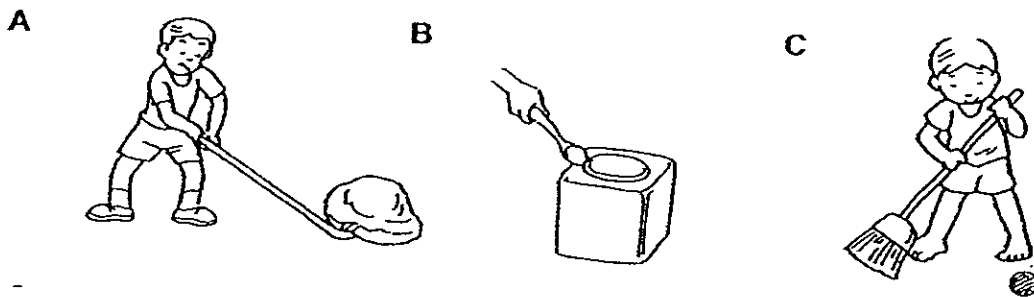

- (1) A only
- (2) A and B only
- (3) B and C only
- (4) A, B and C

17. The diagram below shows four inclined planes. On which plane would the least effort be required to push a similar load up?

(1)

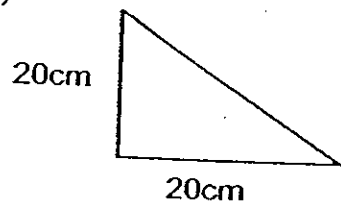

(2)

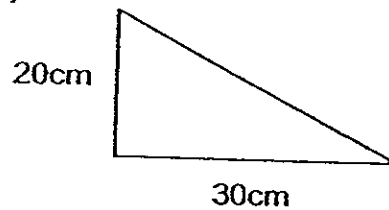

(3)

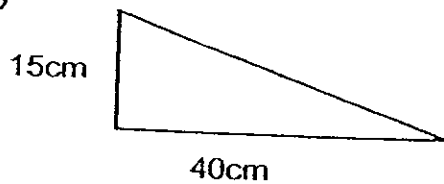

(4)

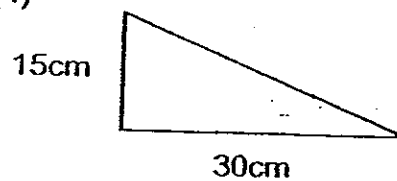

18. Which one of the following statements about the diagram given below is false?

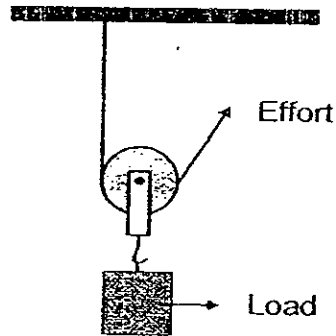

- (1) It is a movable pulley.
(2) The load is being lifted with a greater effort.
(3) It does not change the direction of the applied force.
(4) The effort moves through a longer distance than the load.
19. Study the diagram below. How many turns will Gear A make if Gear B makes 5 turns?

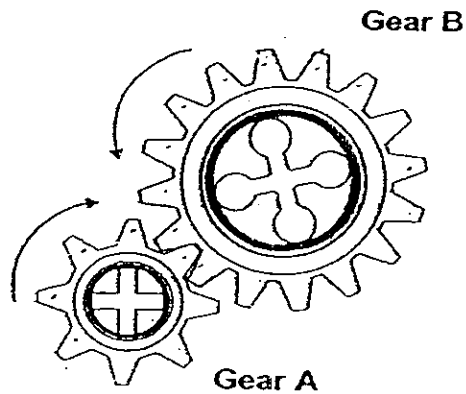

- (1) 5 turns
(2) 8 turns
(3) 10 turns
(4) 16 turns

20. Identical batteries and bulbs were used to set up the following circuits. Which of the bulbs will light up?

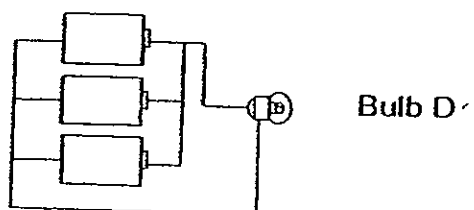
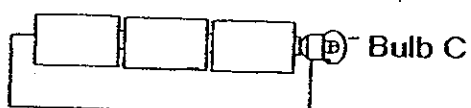
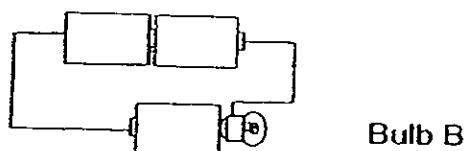
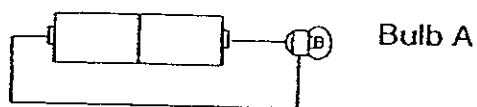

- (1) A and C only
 (3) A, C and D only

- (2) A and D only
 (4) B, C and D only

21. The bulb in the circuit diagram shown below lights up when the wires are connected to pins B and D.

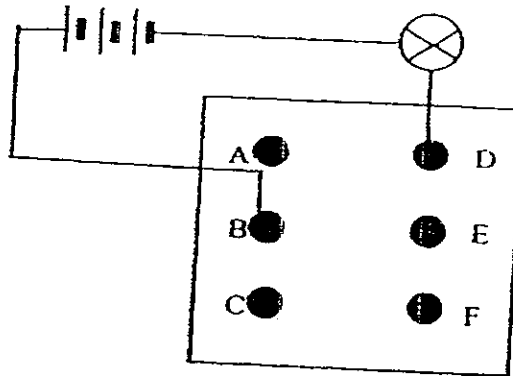

How are the wires at the back of the circuit card connected?

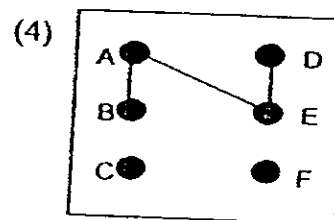
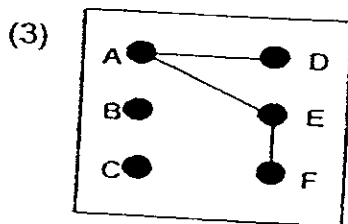
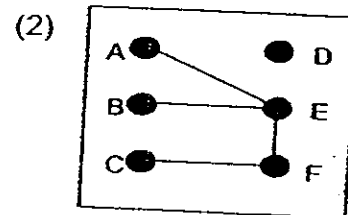
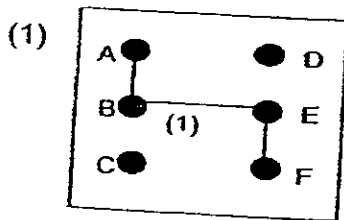

22. The diagram below shows a circuit tester.

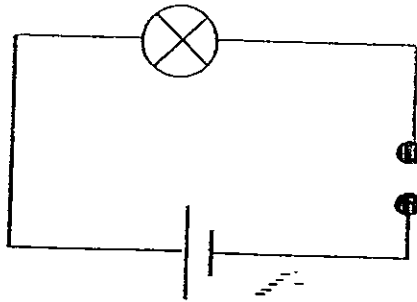

Which of the following item(s) when placed in the gap will allow the bulb to light up?

- (A) Gold coin
- (B) Steel rod
- (C) Aluminium foil
- (D) Eraser

- (1) C only
- (2) A and C only
- (3) A, B and C only
- (4) All of the above

23. Which one of the following activities helps to conserve electricity?

- (1) Use air-conditioners instead of fans.
- (2) Use energy-saving bulbs.
- (3) Leave the lights on when we are sleeping.
- (4) Use a clothes dryer instead of hanging clothes out to dry on a sunny day.

24. A well-watered rose plant is placed in a glass container as shown below. The amount of carbon dioxide and oxygen found in the container at the start of the experiment is as shown below.

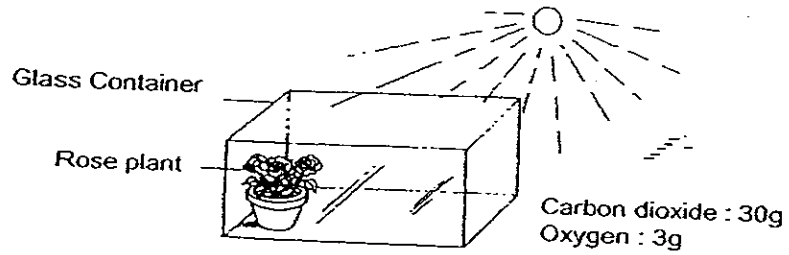

If the rate of photosynthesis is **faster** than the rate of respiration, which of the following shows the most likely amount of gases in the glass container after a few hours?

	Carbon dioxide	Oxygen
(1)	30g	3g
(2)	35g	6g
(3)	25g	6g
(4)	35g	1.5g

25. When do plants carry out respiration?

- (1) All the time.
- (2) Only at night.
- (3) Only in the day.
- (4) Only when there is a need.

26. Study the flow chart below carefully.

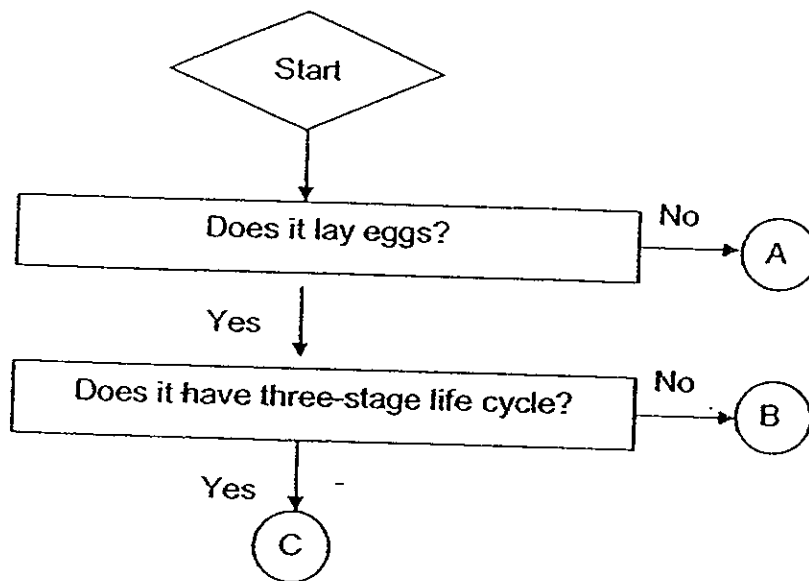

Which of the following represents A, B and C correctly?

	A	B	C
(1)	Chicken	Beetle	Grasshopper
(2)	Platypus	Butterfly	Dragonfly
(3)	Bat	Cockroach	Duck
(4)	Guppy	Mosquito	Chicken

27. Tom did an experiment with a stalk of white flower. He sliced part of the stalk of the flower into half and put one half into blue-coloured water and the other half into red-coloured water.

The next morning, he observed that some parts of the flower petals turned blue and some parts turned red. What can Tom conclude from this experiment?

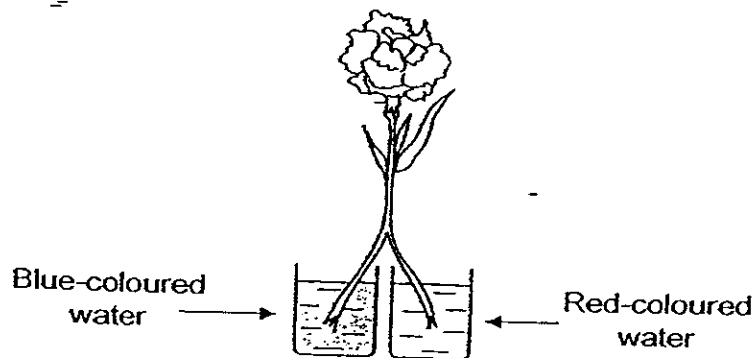

- (1) The flower is able to absorb water.
 - (2) The flower takes in water through its leaves.
 - (3) There are tiny tubes in the stalk that transport food.
 - (4) There are tiny tubes in the stalk that transport water.
28. Which one of the following statements is incorrect?
- (1) The skull protects the brain and the eyes.
 - (2) The spine is made up of one piece of bone.
 - (3) The joints allow the bones to bend and move.
 - (4) The skeleton gives the body shape and support.

29. Jane made a small sailing boat using paper and wood. She put a metal rod on it. When she placed Object P near end X of the metal rod, the boat began to move away. When she placed Object P near end Y, the boat moved towards it. She repeated the experiment three times and obtained the same results.

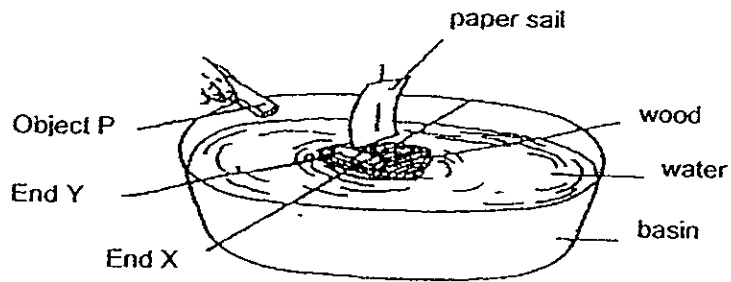

Which of the following statements is/are true?

- (A) The metal rod is a magnet.
- (B) Object P is a magnet
- (C) Object P is made of iron but is not a magnet.
- (D) The metal rod is made of iron but is not a magnet.

- (1) A and B only
- (3) B and D only

- (2) A and C only
- (4) C and D only

30. Fatimah had 4 magnets, A, B, C and D as shown below.

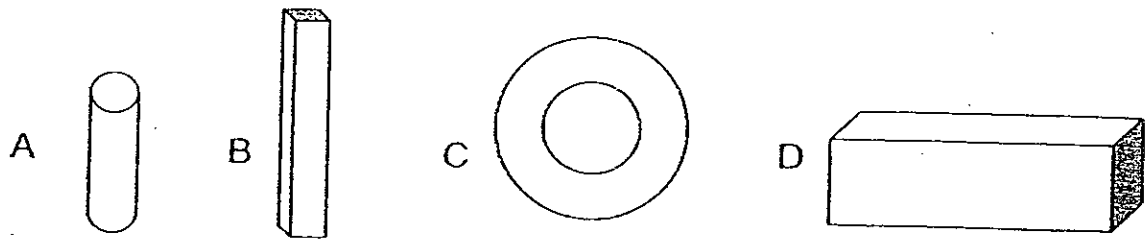

To compare the strength of the magnets, she placed each of the magnets near a tray of pins. The table below shows the number of pins attracted by the magnets from various distances.

Magnet	Distance between magnet and pins (cm)	Number of pins attracted
A	5	16
B	3	14
C	7	12
D	3	16

Based on the results above, which one of the following statements is definitely true?

- (1) Magnet A is stronger than Magnet B.
- (2) Magnet B is stronger than Magnet D.
- (3) Magnet C is the weakest.
- (4) Magnet D is the strongest.



NAN HUA PRIMARY SCHOOL
SEMESTRAL ASSESSMENT 2
PRIMARY FIVE
SCIENCE

Name : _____ ()

Class : Primary 5 / _____

MARKS	
40	

Section B: (40marks)

Write your answers to question 31 to 46.

The number of marks available is shown in brackets [] at the end of each question or part question.

31. A long time ago, scientists had different ideas about the Sun, the Moon and the Earth. Now we know that only some of their ideas are true. Tick one box in each row on the table to say whether each idea is true or false. [2M]

Idea	True	False
The Sun orbits the Earth.		
The Sun is hidden behind the Moon at night.		
The Moon does not give out light on its own. It reflects light from the Sun.		
Night is dark because thick clouds cover the Sun.		

Score	2
-------	---

32. Study the family tree below.

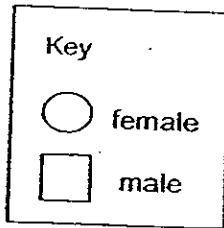

ff – fair-haired
 df – dark-haired
 The letters 'ff' and 'df' represent the traits an individual inherits from his/her parents.

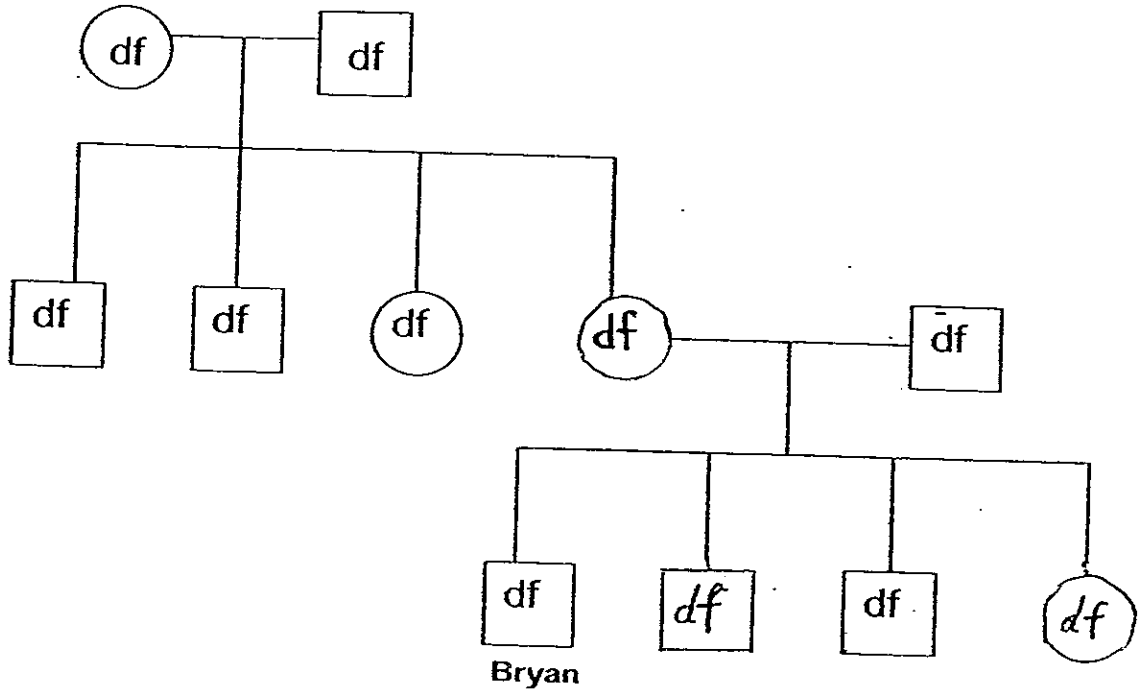

(a) From whom did Bryan inherit his dark hair? [1M]

(b) How many brother(s) does Bryan have? [1M]

(c) Shade the individuals who are fair-haired in the family tree above. [1M]

Score	3
-------	---

33. Study the classification table on the plants given below.

A	B	C	D
lady's finger	potato	bryophyllum	banana
tomato	garlic	African violet	pineapple
chilli	onion	begonia	ginger

(a) How are the plants grouped? [1M]

(b) Which plant has been placed in the wrong group? Explain why. [2M]

Score	3
-------	---

34. A group of pupils made 3 circuits in an experiment. They used a light sensor to measure the brightness of one of the bulbs in each circuit. The sensor gave the results on the graph below.

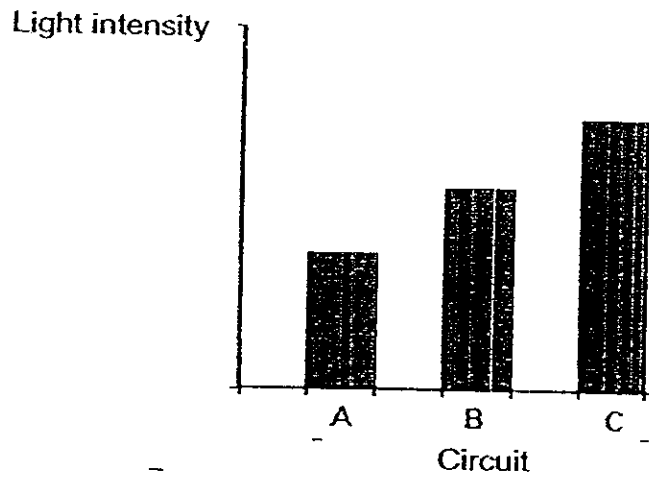

Write A, B or C in each circuit below to show which circuit gave each light sensor reading on the graph. [2M]

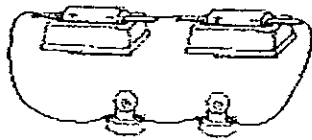

Circuit _____

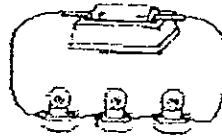

Circuit _____

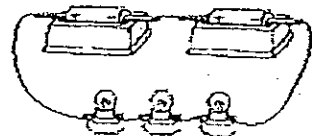

Circuit _____

Score	2
-------	---

35. The six arrows in the diagram below show exchanges of gases between living things and their surroundings.

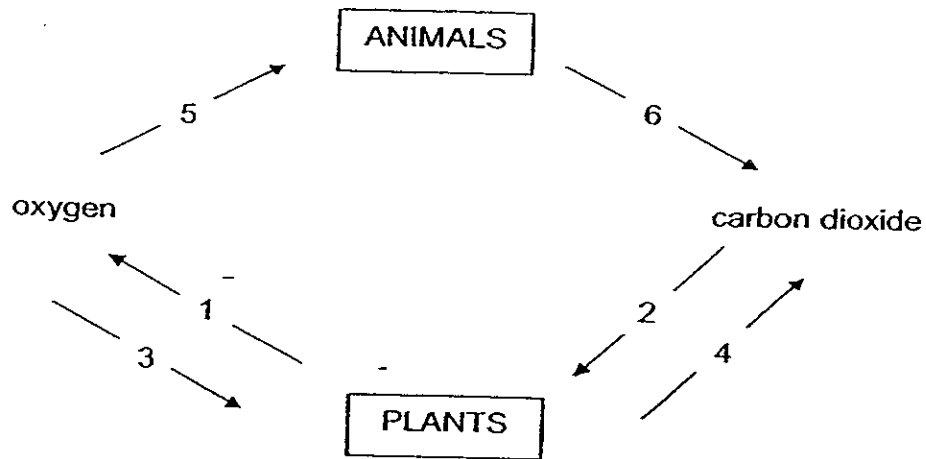

- (a) Which two arrows show the process of respiration in plants? [1M]

- (b) Name the product not shown in the diagram that is formed during photosynthesis. [1M]

Score	2
-------	---

36. Study the diagram below.

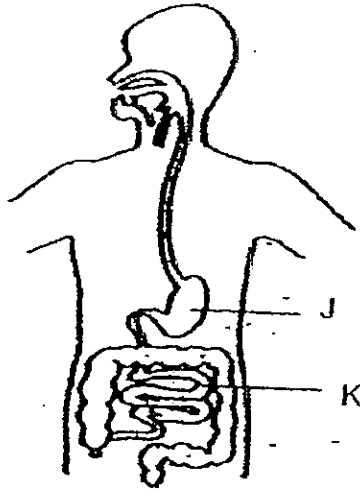

(a) Name parts J and K of the above system.

[1M]

J: _____

K: _____

(b) State one similarity between parts J and K in terms of their function. [1M]

Score	2
-------	---

37. Isabel used 2 different types of cells, X and Y, for her experiment. She placed both cells in a container of pure water. She left the containers overnight and observed the cells under the microscope the next day. These were her observations:

	Cells in Pure Water
Cell X:	Cell remains tight and firm
Cell Y:	Cell became swollen and eventually burst

- (a) From the observations, which cell is likely to be a plant cell? [1M]

- (b) Explain your answer in (a). [2M]

Score	3
-------	---

38 (a)

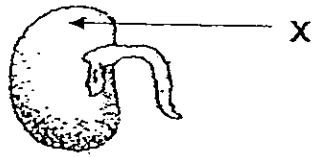

The diagram shows a germinating seed.

(i) Name the part X

[1M]

(ii) State the function of part X.

[1M]

(b) Study the bryophyllum leaf below.

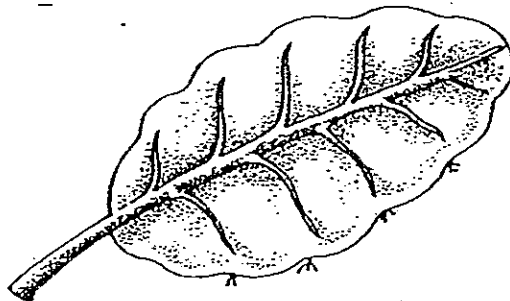

Draw an arrow and label with the letter 'X' the part where tiny shoots would grow.

[1M]

Score	
	3

39. Study the diagram below. The lid on the tin is fitted tightly. Wilson has a coin and a metal spoon.

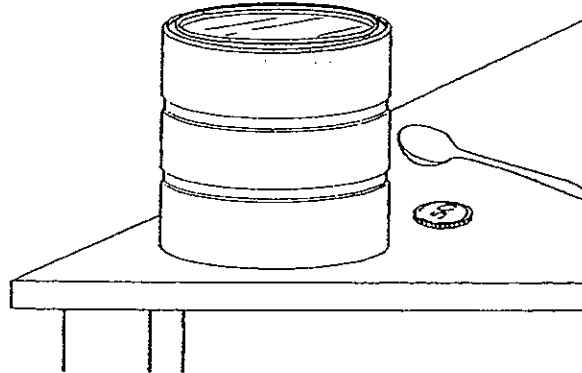

- (a) Should he use the coin or the metal spoon to lift the lid? Explain your answer. [2M]

- (b) What type of simple machine is described in your answer for (a)? [1M]

Score	3
-------	---

40. The diagram below shows two different pulleys.

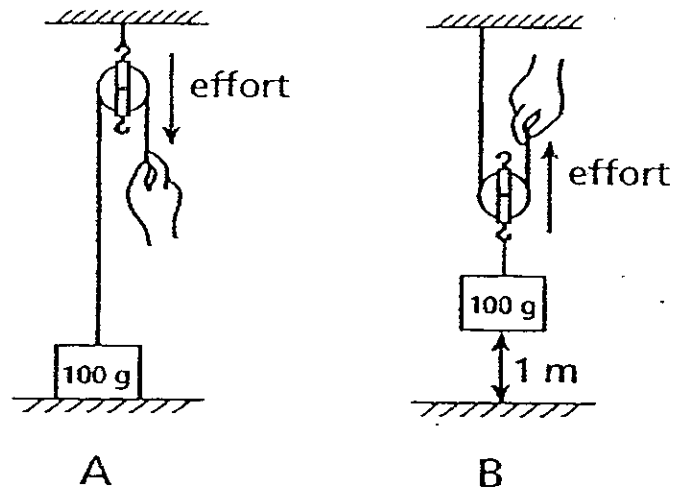

- (a) Which pulley system, A or B, requires less effort to lift the load? [1M]

- (b) What is the distance moved by the effort in pulley A when the load moves 1 metre? [1M]

Score	2
-------	---

41. In the space below, draw a circuit diagram (using symbols) that includes 3 batteries, 3 bulbs and 3 switches. Ensure that every bulb can be switched on or switched off without affecting the other 2 bulbs. [2M]

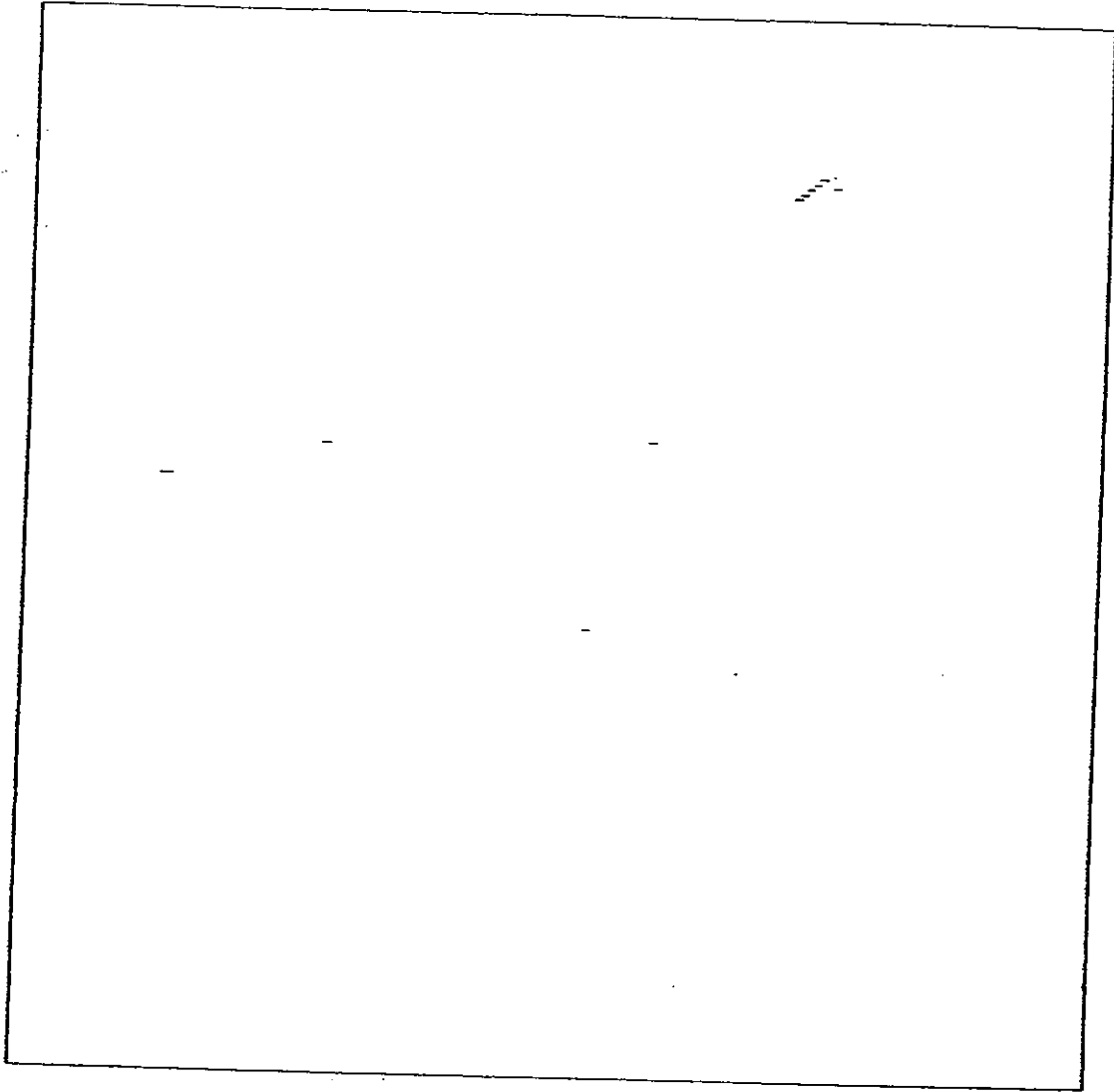

Score	2
-------	---

42. Study the circuits below carefully.

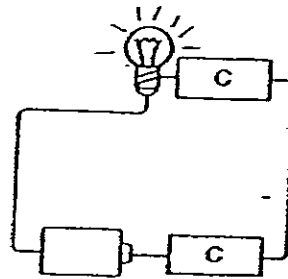
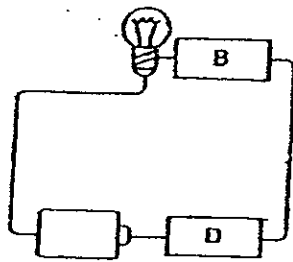
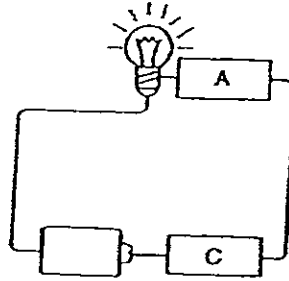
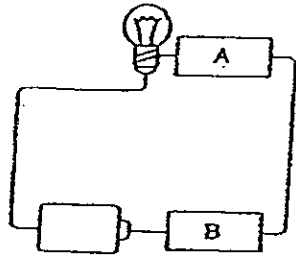

Put a tick (✓) in the table below to indicate if the materials (A, B, C and D) used are "conductors of electricity", "non-conductors of electricity" or "not possible to tell". [2M]

Material	Conductors of electricity	Non-Conductors of electricity	Not possible to tell
A			
B			
C			
D			

Score	
-	2

43. Put a "T" for statements that are true or an "F" for statements that are false. [2M]
- (a) Photosynthesis is the process by which green plants use light energy to make food. ()
 - (b) Chlorophyll in leaves absorbs light energy. ()
 - (c) Carbon dioxide and sugar are produced during photosynthesis. ()
 - (d) The excess food made during photosynthesis is changed into starch and stored in different parts of the plant. ()

44. Study the set-up below.

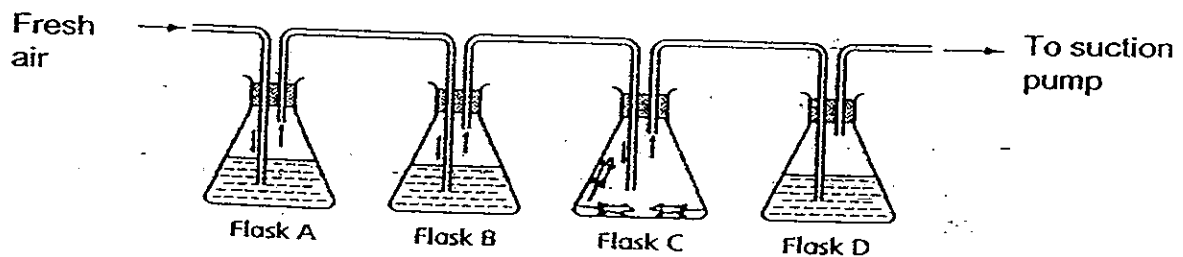

Fresh air is channelled into Flask A where carbon dioxide is absorbed. Then the air passes through the limewater in Flask B before it enters Flask C that has a few lizards in it. After that, the air enters Flask D that contains limewater.

- (a) What will happen to the limewater when air enters Flask D? [1M]

- (b) Give a reason for your answer in (a). [2M]

Score	5
-------	---

45. Look at the picture of a plant below.

(a) Name plant part X and explain how it helps the plant to survive. [2M]

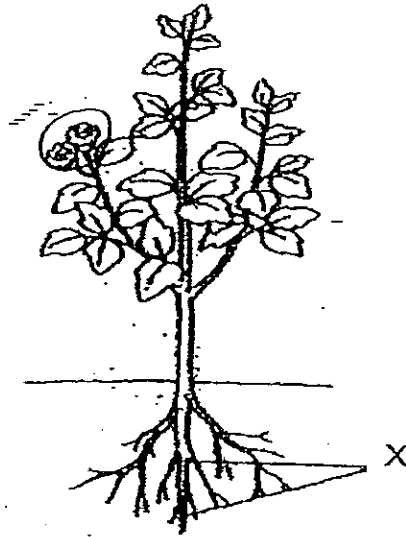

(b) Circle the part of the plant that will develop into a fruit. [1M]

Score	3
-------	---

46. Study the diagram below.

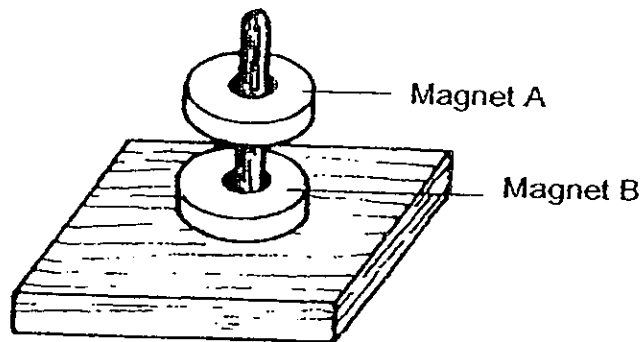

(a) Explain why Magnet A floats above Magnet B?

[1M]

(b) What will happen if Magnet A is removed and then heated in a strong flame before it is put back in position? Give a reason for your answer.

[2M]

END-OF-PAPER

Setters: Mr Leong SY
Ms Sam PF

Score	3
-------	---

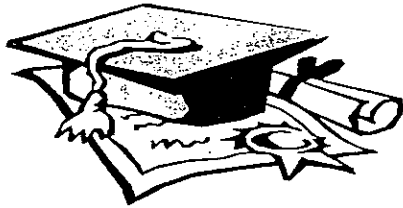

ANSWER SHEET

EXAM PAPER 2008

SCHOOL : NAN HUA PRIMARY SCHOOL

SUBJECT : PRIMARY 5 SCIENCE

TERM : SA 2

Q1	Q2	Q3	Q4	Q5	Q6	Q7	Q8	Q9	Q10	Q11	Q12	Q13	Q14	Q15	Q16	Q17
1	3	4	4	1	1	3	2	3	2	2	3	3	2	1	4	3

Q18	Q19	Q20	Q21	Q22	Q23	Q24	Q25	Q26	Q27	Q28	Q29	Q30
2	3	4	4	3	2	3	1	4	4	2	1	1

31)a)F b)F c)T d)F

32)a)His father.

b)2

c)

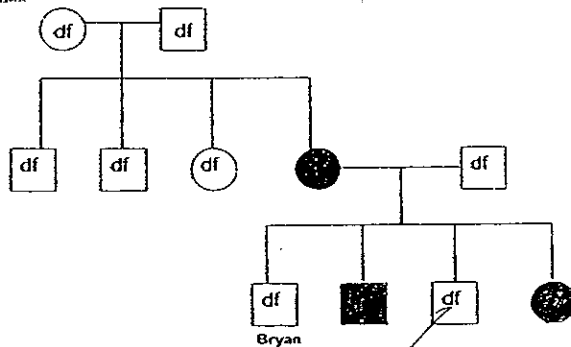

33)a)According to how they reproduce.

b)The ginger. It reproduces by underground stems instead of suckers.

34) C, A, B

35) a) Arrow 3 and 4.

b) Glucose.

36) a) J: Stomach.

K: Small intestine.

b) They help to digest food.

37) a) Cell X.

b) Cell X remained tight and firm so it has a cell wall that plant cells have.

38) a) i) Seed coat. ii) It protects the seed.

b)



39) a) Metal spoon. As it is longer, the distance between the effort and fulcrum is greater, hence less effort will be required to lift the lid.

b) A level.

40) a) B b) 1 metre.

41)

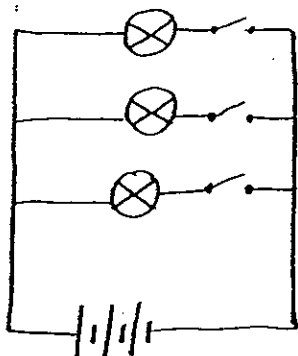

- 42)A: Conductors of electricity.
B: Non-Conductors of electricity.
C: Conductors of electricity.
D: Not possible to tell.

- 43)a)T
b)T
c)F
d)T

- 44)a)It will turn chalky.
b)Carbon dioxide is produced when the lizard respire.

45)a)

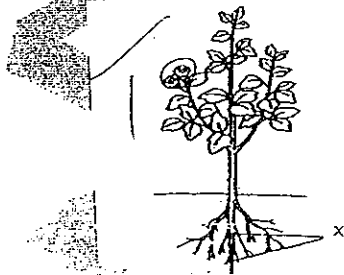

- b)To anchor the plant firmly to the ground.

46)a)The like poles of magnet A and B are facing each other. Hence the magnets repelled.

b)The distance that Magnet A repelled with Magnet B would be shorter. Magnet A lost some of its magnetism through heating.