

SINGAPORE CHINESE GIRLS' SCHOOL (PRIMARY)
SECOND SEMESTRAL ASSESSMENT 2017

NAME: _____ ()

DATE: 13 October 2017

CLASS: PRIMARY 5 SY / C / G / SE / P

Parent's Signature: _____

SCIENCE
BOOKLET A

28 questions

56 marks

Total time for Booklets A & B: 1 h 45 min

DO NOT OPEN THIS BOOKLET UNTIL YOU ARE TOLD TO DO SO.

FOLLOW ALL INSTRUCTIONS CAREFULLY.

Part I (56 marks)

For each question from 1 to 28, four options are given. One of them is the correct answer. Make your choice (1, 2, 3 or 4). **Shade the correct oval (1, 2, 3 or 4) on the Optical Answer Sheet.**

1. Study the classification chart on animals below.

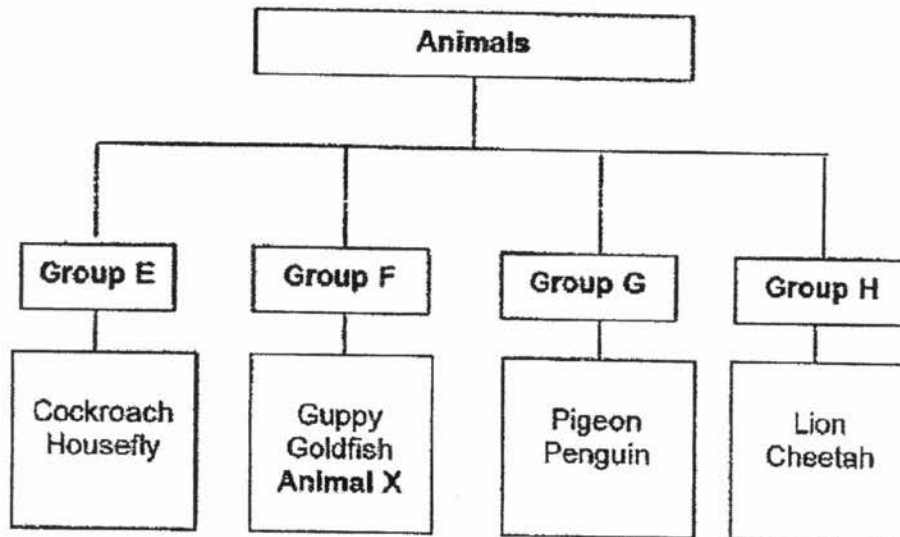

Which one of the following is **Animal X** most likely to be?

- (1) Butterfly
 - (2) Shark
 - (3) Dolphin
 - (4) Frog
2. The diagram below shows the roots of a plant.

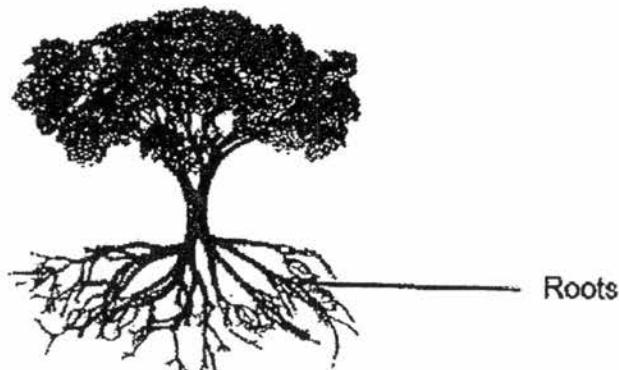

Which one of the following best describes the function of the roots?

- (1) It holds the plant upright.
- (2) It absorbs water and mineral salts for the plant.
- (3) It transports water to the plant.
- (4) It transports mineral salts to the plant.

3. The flow chart below shows the characteristics of objects A, B and C.

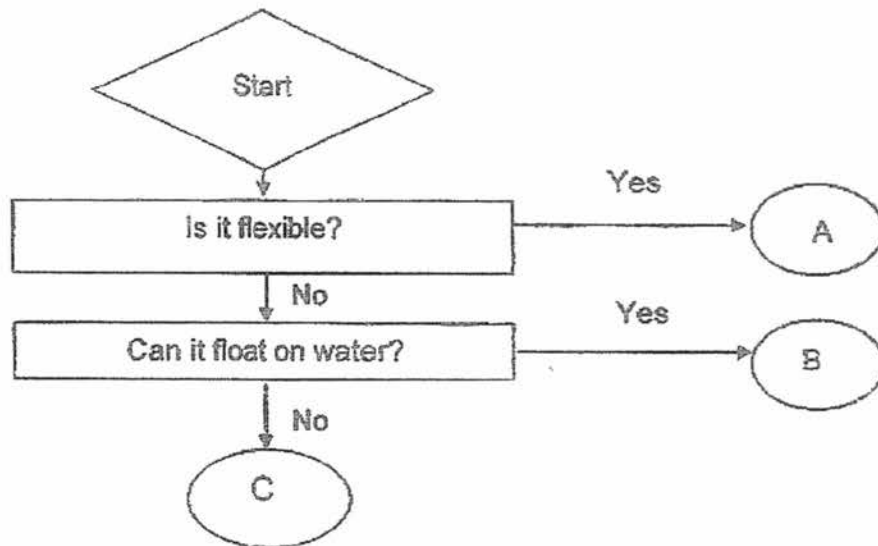

Which of the following could objects A, B and C be?

	A	B	C
(1)	Rubber band	Ping pong ball	Coin
(2)	Rubber band	Coin	Ping pong ball
(3)	Coin	Ping pong ball	Rubber band
(4)	Coin	Rubber band	Ping pong ball

4. The table below contains some information about Organisms X and Y.

	Characteristics	
Organism X	Does not make its own food	Can move from place to place
Organism Y	Makes its own food	Cannot move from place to place

Which of the following could Organisms X and Y be?

	Organism X	Organism Y
(1)	Mushroom	Fern
(2)	Mushroom	Rabbit
(3)	Rabbit	Fern
(4)	Rabbit	Mushroom

5. The diagram below shows light from a torch shining on 3 cardboard shapes arranged from different distances from the torch. All the cardboards have identical heights.

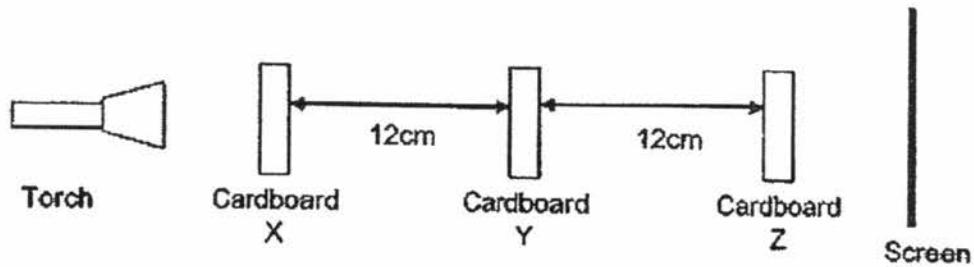

The diagram below shows the shadow that was formed on the screen.

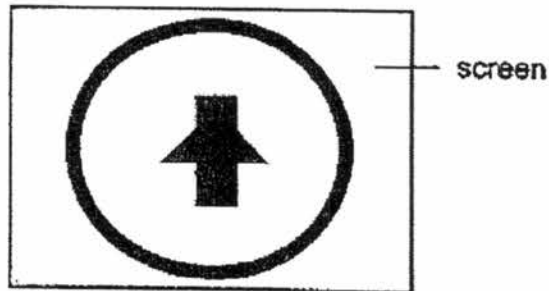

Which of the following correctly shows the arrangement of cardboards X, Y and Z that are used to form the shadows shown above?

	X	Y	Z
(1)			
(2)			
(3)			
(4)			

6. Kelly wanted to find out how the rate of evaporation of water was affected by the temperature of water. She conducted the experiment using 4 set-ups P, Q, R and S as shown in the table below. The table below shows the conditions at the start of the experiment.

	P	Q	R	S
Volume of water (ml)	200	200	200	200
Exposed surface area of water (cm ²)	100	100	200	200
Temperature of room (°C)	28	20	28	28
Temperature of water (°C)	40	60	40	60

Which of the following pair of set-ups should Kelly use to ensure a fair test?

- (1) P and Q
 (2) Q and R
 (3) R and S
 (4) P and S
7. The diagram below shows a plant with food-carrying tubes removed between positions X and Y while water-carrying tubes remained in the stem.

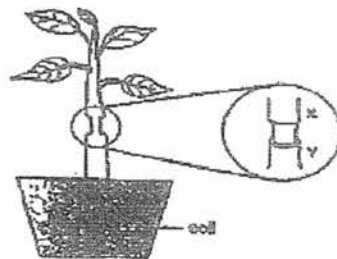

Which one of the following diagrams represents the appearance of the stem after a few days?

- (1) (3)
- (2) (4)

8. The diagram below shows how metal strips, A, B and C, look like before and after heating for 10 minutes.

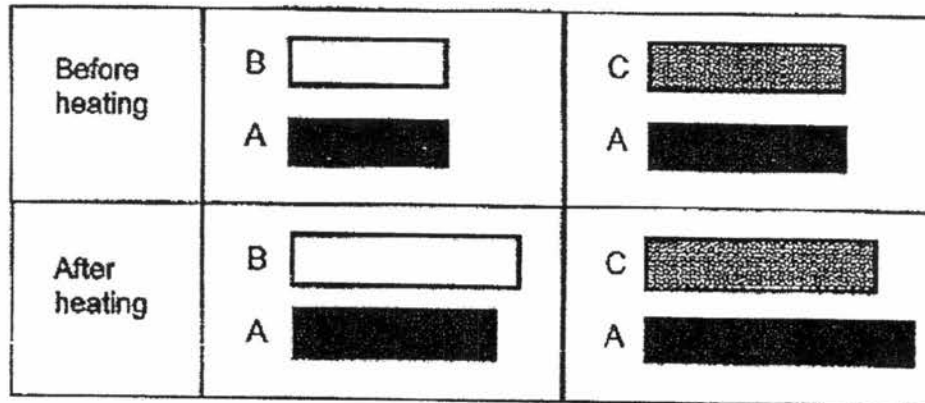

Based on the set-ups shown above, which of the following statements are correct?

- X: B expands more than C when heated.
Y: C expands more than A when heated
Z: A expands more than B when heated.

- (1) X only
(2) X and Y only
(3) X and Z only
(4) Y and Z only
9. What is the function of the large intestine?

- (1) It uses digestive juices to digest food.
(2) It removes excess water from digested food.
(3) It removes excess water from undigested food.
(4) It absorbs digested food into the bloodstream.

10. An experiment is set up as shown in the diagram below. The temperature of water in each set-up is the same at the start of the experiment.

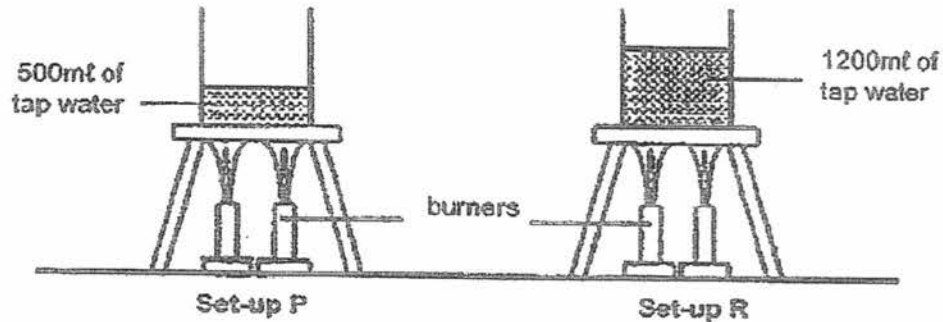

Which of the following statements is most likely to be correct?

- (1) The water in both set-ups will start to boil at the same time.
 - (2) The water in set-up P has more heat energy than the water in set-up R.
 - (3) The water in both set-ups is at the same temperature when it is boiling.
 - (4) The water in set-up R is at a higher temperature than the water in set-up P when it is boiling.
11. Study the diagram below.

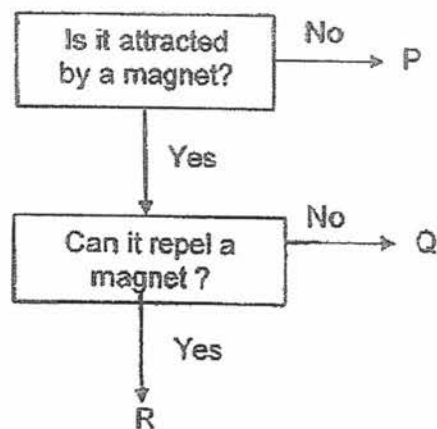

Based on the diagram, which of the following statements are correct?

- A : P is a magnet.
- B : Q can be made into an electromagnet.
- C : R can attract iron nails.
- D : P and Q are non-magnetic materials.

- (1) A and B only
- (2) B and C only
- (3) A and C only
- (4) C and D only

12. The diagram below shows 2 animals.



Butterfly



Mosquito

Based on the diagrams above, in what way(s) is/are the life cycles of the animals similar?

- A : Both give birth to young.
 B : Both their young do not resemble the adults.
 C : Both need to live in water before the adult stage.
 D : Both have to go through the pupal stage before they become adults.

- (1) A only
 (2) C only
 (3) B and D only
 (4) B, C and D only

13. Which of the following shows the correct sequence of reproduction of a flowering plant in one cycle?

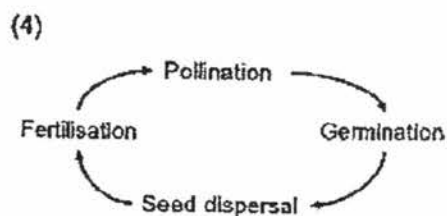
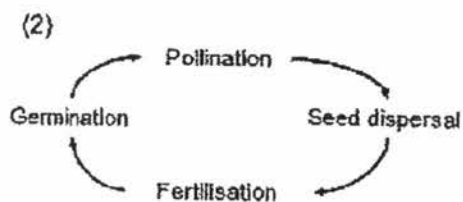
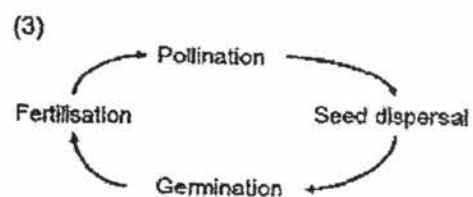
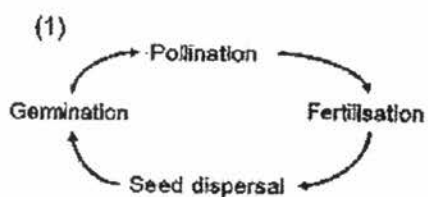

14. Four identical seeds were placed in both Dish A and Dish B as shown below.

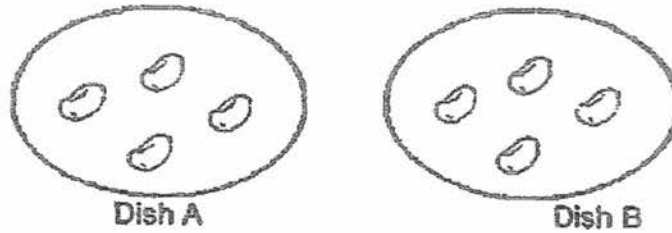

Which of the following conditions will result in only seeds from Dish A germinating?

	Dish A	Dish B
(1)	Placed in the cupboard with water	Placed in the sunny place without water
(2)	Placed in the refrigerator with water	Placed in the cupboard with water
(3)	Placed in the sunny place without water	Placed in the refrigerator with water
(4)	Placed in the cupboard with water	Placed in the cupboard with water

15. The Water Cycle undergoes a few processes that involve heat gain or heat loss. Which one of the following is true about the Water Cycle?

	Changes	Processes	Heat Gain/Loss
(1)	Water → water vapour	Evaporation	Heat loss by water
(2)	Water vapour → cloud	Condensation	Heat loss by water
(3)	Cloud → rain	Evaporation	Heat gain by water
(4)	Cloud → rain	Condensation	Heat gain by water

16. The diagram below shows the mass and volume of 3 boxes, A, B and C.

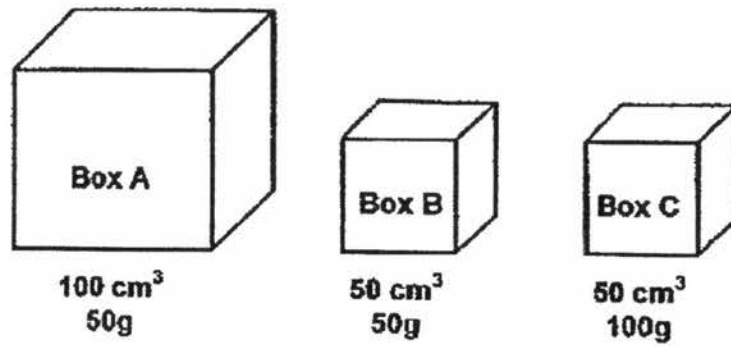

2 boxes were put on a balance at a time. Which one of the following diagrams is correct?

(1)

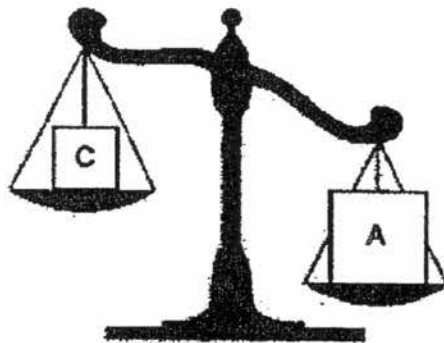

(3)

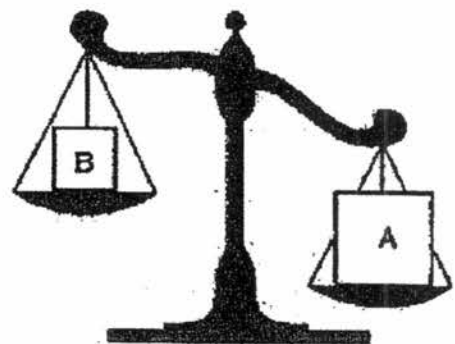

(2)

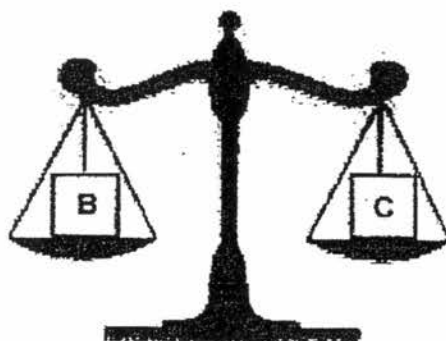

(4)

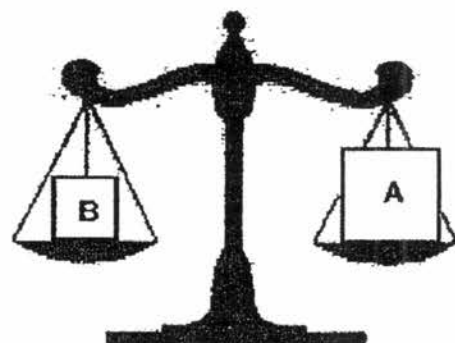

17. Study the circuit below.

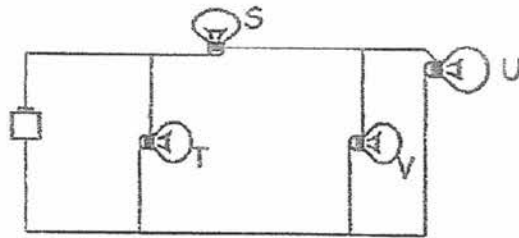

Which bulb(s) will still light up if Bulb V is fused?

- (1) Bulb S and T only
 (2) Bulb S, T and U
 (3) Bulb S and U only
 (4) None of the bulbs
18. Angela set up a circuit with the switches S1, S2, S3 and S4 as shown below.

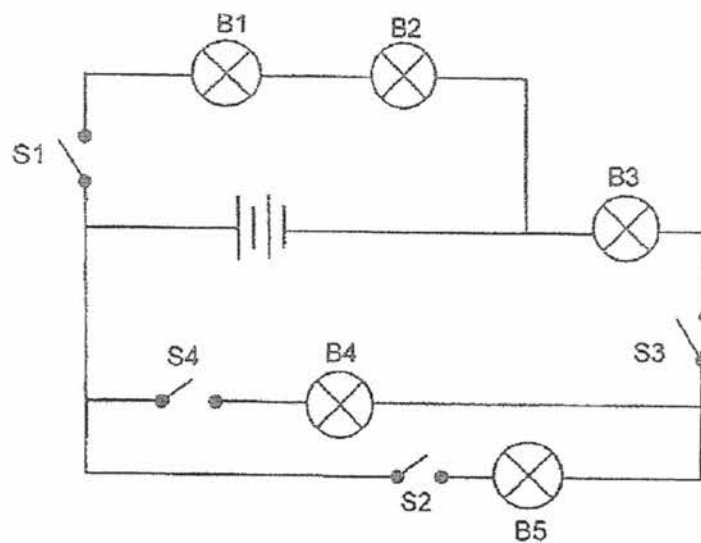

All the 5 bulbs were lit when all 4 switches are closed. Angela wanted to have the fewest number of bulbs to be lit by opening only 1 switch. Which switch should Angela open?

- (1) S1
 (2) S2
 (3) S3
 (4) S4

19. A syringe was inserted into a container containing 100 cm^3 of air. 40 cm^3 of air was taken out from the container by the syringe.

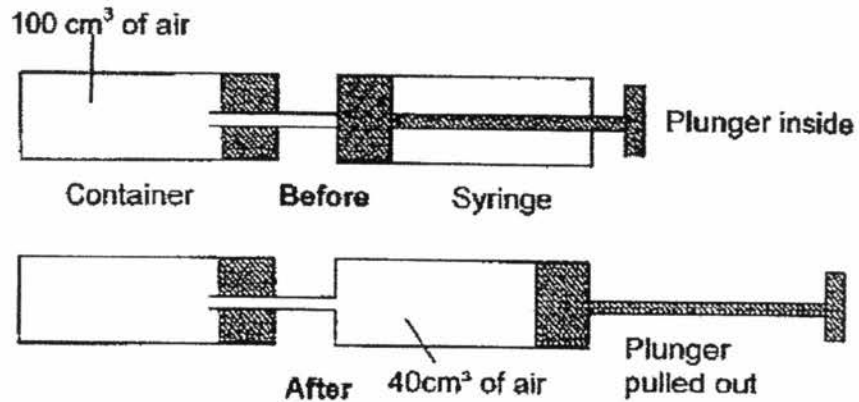

Which one of the following correctly shows the final volumes of air in the container and syringe?

	Volume of air in container (cm^3)	Volume of air in pump (cm^3)
(1)	60	40
(2)	100	40
(3)	140	40
(4)	40	0

20. The following shows a classification chart.

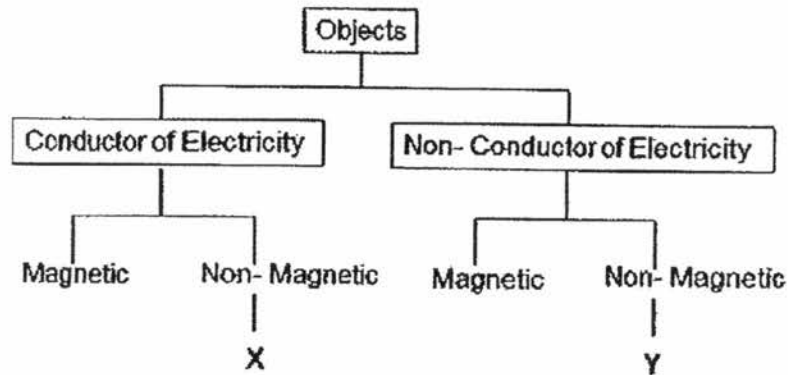

Which one of the following represents X and Y?

	X	Y
(1)	Copper wire	Fabric
(2)	Fabric	Copper wire
(3)	Steel rod	Wooden stick
(4)	Plastic rod	Steel rod

21. The diagram below shows 3 generations of Jane's family that carry the genetic trait for Disease X.

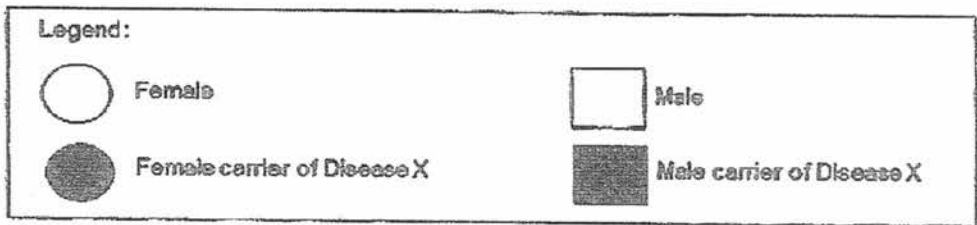
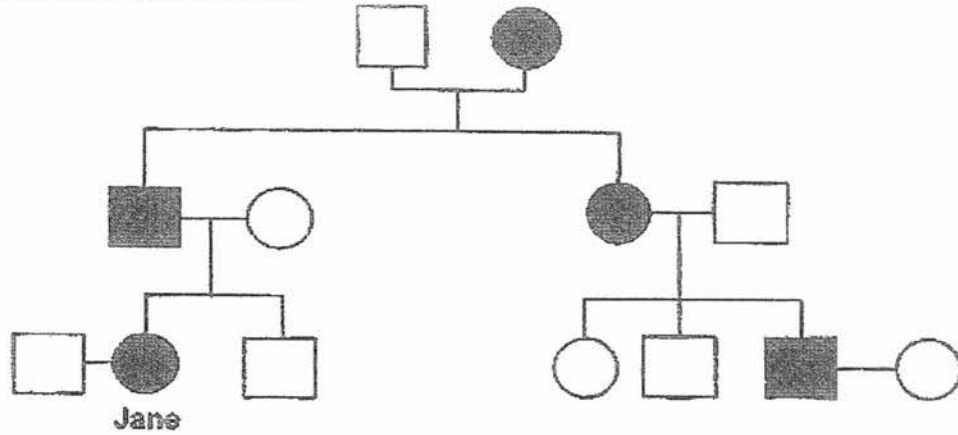

Which of the following statements can you conclude about the family tree?

- A : Jane has a cousin with Disease X.
- B : Jane's mother inherited the genes of Disease X from her grandmother.
- C : There is a possibility of Jane's children inheriting the genes of Disease X
- D : Jane's uncle inherited the genes of Disease X from his grandmother.

- (1) A and C only
- (2) A and D only
- (3) B and D only
- (4) A, B and C only

22. Jessie took some cells from different parts of a plant and an animal. She observed the sample cells under the microscope and recorded her observation in the table below.

	Cell X	Cell Y	Cell Z
Nucleus	√	√	√
Cell wall	√		√
Cytoplasm	√	√	√
Chloroplast			√
Cell membrane	√	√	√

Which one of the following classification is correct?

	Animal Cell	Plant Cell
(1)	Y and Z	X only
(2)	Y only	X and Z
(3)	Z only	X and Y
(4)	X and Y	Z only

23. The graph below shows the relationship between the speed of wind and the distance travelled by seeds P and Q during seed dispersion.

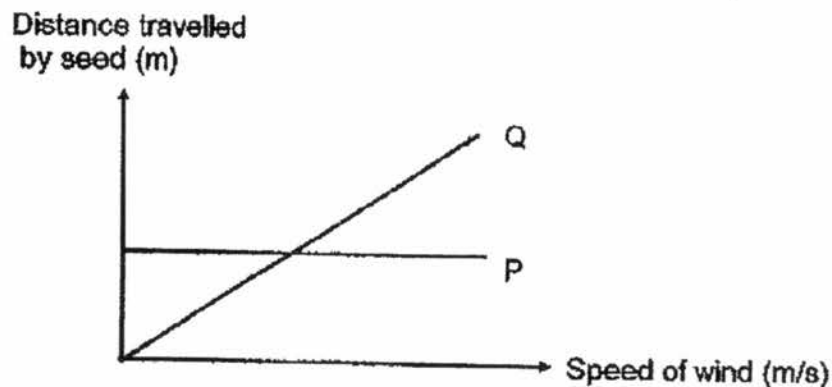

Which of the following most likely are characteristics of seeds P and Q?

	Seed P	Seed Q
(1)	Soft hair	Fibrous husk
(2)	Fibrous husk	Stiff hair
(3)	Wing-like structure	Seeds are in a pod
(4)	Sweet and juicy	Soft hair

24. Photo B is taken at same place as Photo A but a few months later.

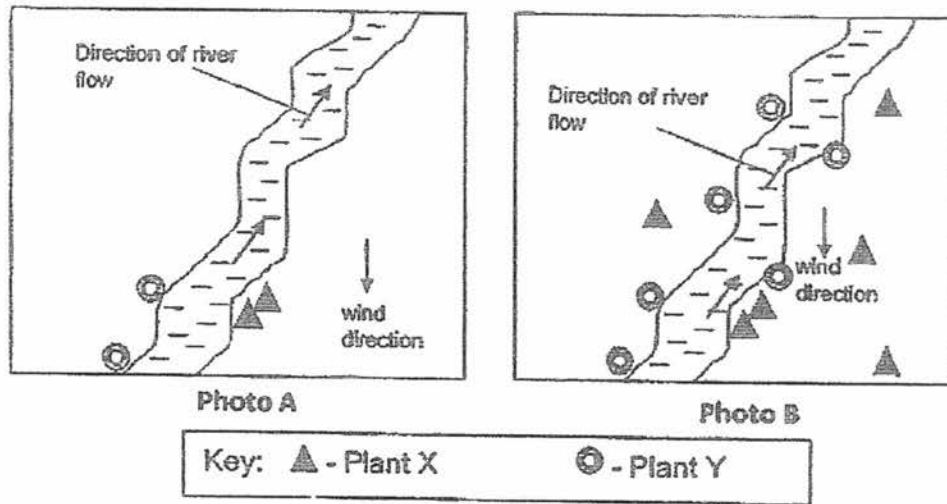

Based on the 2 pictures above, what are the likely characteristics of the fruits of Plant X and Plant Y?

	Fruit of Plant X	Fruit of Plant Y
(1)	By wind	By Man/animals
(2)	By splitting	By water
(3)	By Man/animals	By water
(4)	By wind	By wind

25. Which of the following statement(s) is/are correct?
- A. All green plants can make their own food.
 B. Plants produce starch and oxygen during photosynthesis.
 C. Respiration occurs only at night while photosynthesis occurs only during the day.
 D. Leaves that are partially green can make their own food.
- (1) A, B and C (3) B and D only
 (2) A and B only (4) A and D only

26. The diagrams below show some bracket fungus on a tree and some mould on an orange.



Bracket fungus



Mould

Which of the following statements about the bracket fungus and mould is correct?

- (1) The mould disperses its ^{spores} seeds by wind.
- (2) Both organisms are non-flowering plants.
- (3) Both organisms need oxygen for their life processes.
- (4) Bracket fungus makes its own food but the mould does not.
27. The below set-up shows the amount of gas collected at the end of 5 hours when light intensity is 20 lux,



Fluorescent lamp

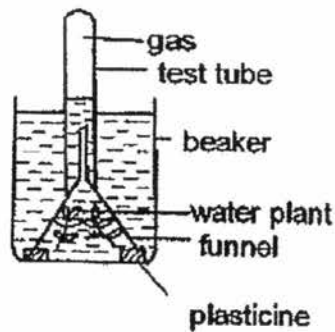

Which of the following set-ups correctly shows the results when the fluorescent lamp was placed nearer to the water plant?

(1)

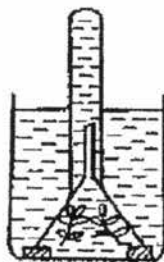

(3)

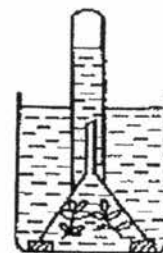

(2)

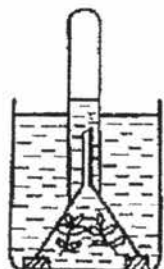

(4)

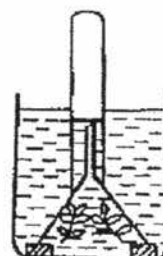

28. The graph below shows the heart rate of Damien from the start to the end of his jog.

Number of heartbeats
(per minute)

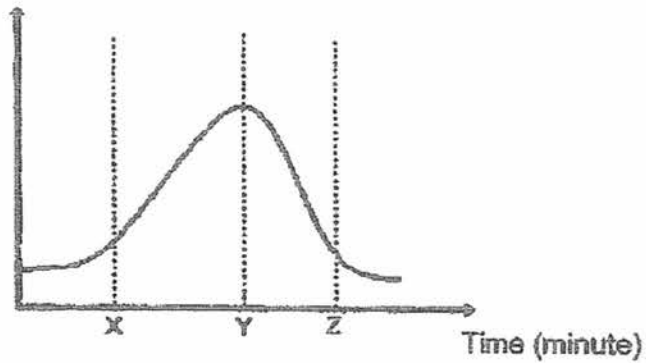

Between time periods, X to Y and Y to Z, which of the following best represents what is happening in his body?

	Period X to Y		Period Y to Z
	Rate of blood flow	Amount of carbon dioxide released	Rate of use of digested food
(1)	Decrease	Decrease	Increase
(2)	Decrease	Increase	Decrease
(3)	Increase	Decrease	Increase
(4)	Increase	Increase	Decrease

-----End of Booklet A-----

SINGAPORE CHINESE GIRLS' SCHOOL (PRIMARY)

SECOND SEMESTRAL ASSESSMENT 2017

NAME: _____ ()

DATE: 13 October 2017

CLASS: PRIMARY 5 SY / C / G / SE / P

Parent's Signature:

SCIENCE
BOOKLET B

	Total Actual Marks	Total Possible Marks
Booklet A		56
Booklet B		44
Total		100

12 questions

44 marks

Total time for Booklets A & B: 1 h 45 min

DO NOT OPEN THIS BOOKLET UNTIL YOU ARE TOLD TO DO SO.

FOLLOW ALL INSTRUCTIONS CAREFULLY.

Part II (44 marks)

Answer all the following questions.

29. Look at the diagrams below carefully.

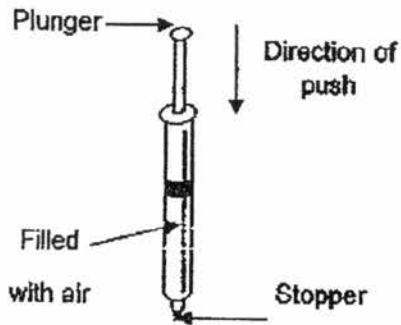

Syringe A

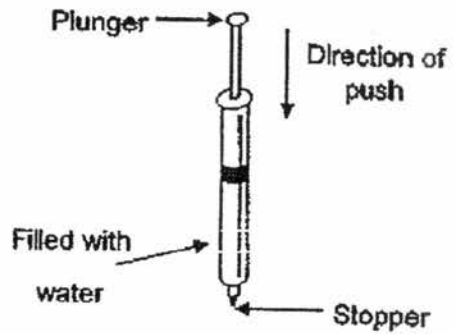

Syringe B

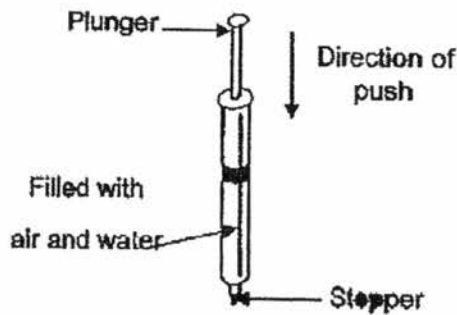

Syringe C

(a) The plunger can be pushed downwards in syringe(s) _____ because _____ . (2m)

(b) The plunger cannot be pushed downwards in syringe(s) _____ because _____ . (2m)

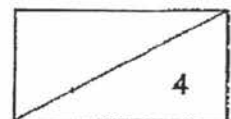

30. The table below shows the states of 4 substances, A, B, C and D at different temperatures.

Substance	State of substances at		
	25°C	50°C	75°C
A	solid	solid	solid
B	liquid	liquid	gas
C	solid	liquid	liquid
D	liquid	gas	gas

(a) Based only on the table above, tick (✓) 'True', 'False', or 'Not Possible to Tell' for the following statements. (2m)

		True	False	Not Possible to Tell
(i)	Substance A has the lowest freezing point.			
(ii)	Substance B is a liquid at 70°C.			
(iii)	The melting point for C is at 30°C.			
(iv)	Substance D has the lowest boiling point.			

(b) In the diagram below, draw how substance C will look like when it is tilted in the cup at 60°C. (1m)



before tilt

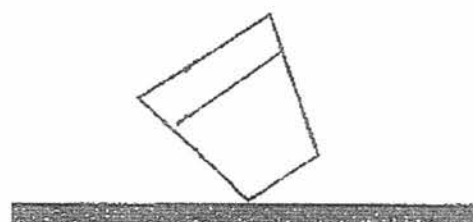

after tilt

31. Joe conducted an experiment to find out the amount of light reflected by different materials, A, B, C and D. He set up the experiment as shown below.

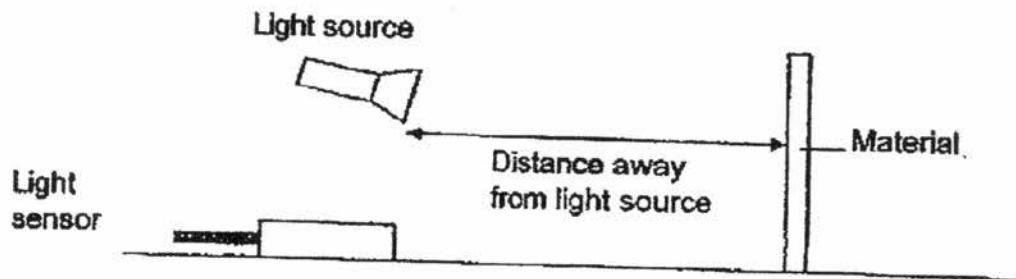

Joe recorded his results and plotted them in a graph as shown below. The graph showed the amount of light that was reflected by materials, A, B, C and D as he varied the distance between the light source and the material.

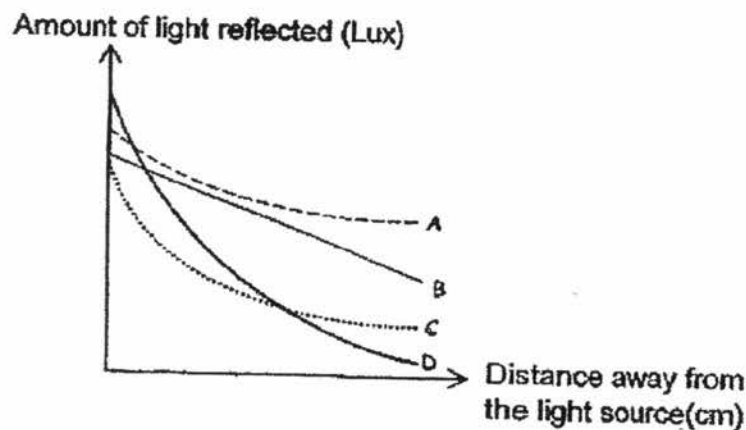

- (a) What variable was the light sensor measuring? (1m)
- (b) State 2 variables that he should keep the same to ensure a fair test.
- Variable 1 : _____ (1m)
- Variable 2 : _____ (1m)
- (c) Joe wanted to paste reflective strips on his bicycle so that it would be safe for him to cycle at night.

Based on the results above, which materials, A, B, C or D, should he choose for the reflective strips on his bicycle? Explain your answer. (1m)

32. Michael prepared 2 set-ups, X and Y, as shown below. He placed 2 pieces of pipe into a basin of water at a certain temperature. Then he placed the lids at different temperatures on top of each pipe.

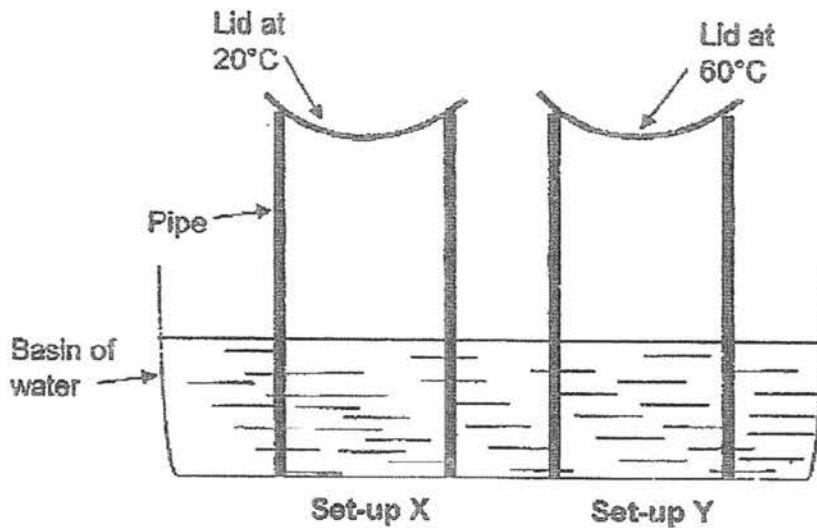

After 5 minutes, Michael observed some water droplets form on the underside of the lids in both set-ups. There were more water droplets formed in Set-up X than in Set-up Y.

- (a) Predict the temperature of water in the basin. (1m)

- (b) Explain why there are more water droplets formed in Set-up X. (2m)

33. Mrs Tan boiled a pot of barley drink for her children. However, it was too hot to be consumed immediately. She added some ice cubes to a basin. Next, she placed the cup of hot barley drink in the basin of ice. After 15 minutes, she used a thermometer to measure the temperature of the barley drink.

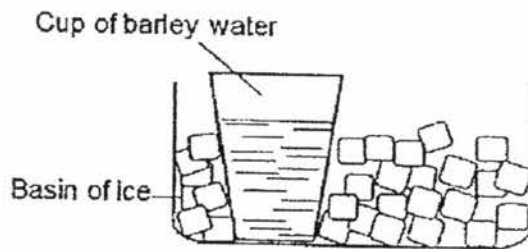

- (a) What would happen to the temperature of the hot barley drink after 15 minutes? Explain your answer. (1m)

Mr Tan went to a drink stall to buy a drink. He noticed that the ice was crushed instead of the usual ice cubes.

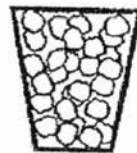

Crushed ice

- (b) Explain how using crushed ice makes the drink cool down faster than using ice cubes. (1m)

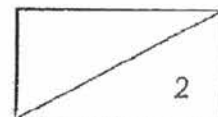

34. Using a circuit tester, Alan conducted an experiment to test a circuit card and recorded his results in the table below.

Clips connected to paper clips on circuit tester	Bulb of circuit tester
A and B	Lighted up
A and C	Did not light up
C and D	Did not light up
A and E	Lighted up
B and E	Lighted up
A and D	Did not light up

- (a) Based on the information above, draw 2 straight lines in the diagram below to show how the wires were connected in the circuit tester. (1m)

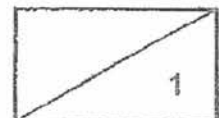
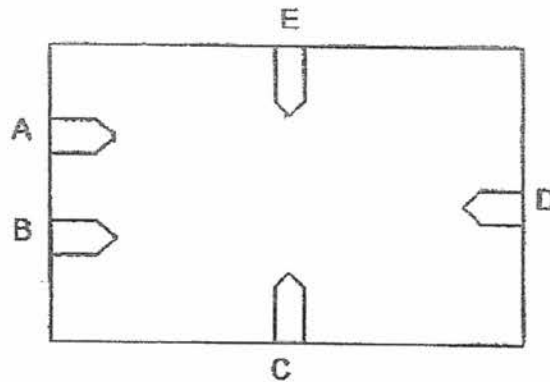

34.(b) In a separate experiment, Alan set up the circuit below with 4 gaps, P, Q, R and S where different objects could be connected to.

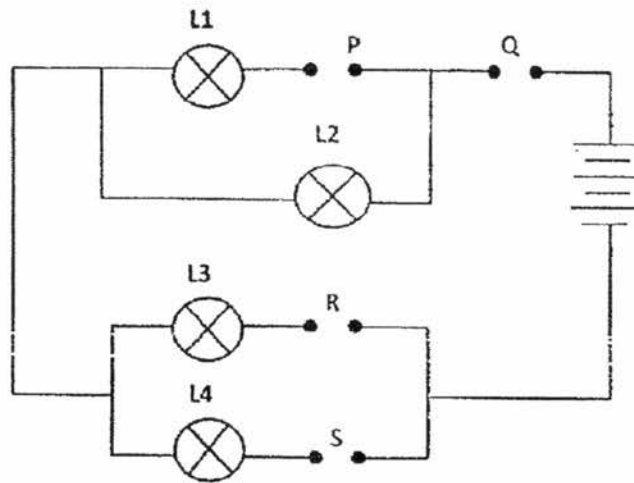

He connected the ends of 4 rods A, B, C and D to each of the gaps. He recorded his observation in the table below. A tick (✓) in the box indicated that the bulb had lit up and a cross (X) indicated that the bulb did not light up.

Position of rod				Light bulb(s) that lit up			
Gap P	Gap Q	Gap R	Gap S	L1	L2	L3	L4
A	B	C	D	X	✓	✓	X

Based on the circuit above, identify which rods, A, B, C and D, are conductors and non-conductors of electricity. (2m)

Conductors of electricity: _____

Non-conductors of electricity: _____

(c) The rods A, B, C and D are re-arranged in 2 different ways shown in the table below. Put a tick (✓) in the appropriate boxes to show which bulbs L1, L2, L3 or L4 will light up and a cross (X) to show which bulb will not light up. (2m)

Position of rod				Light bulb(s) that lit up			
Gap P	Gap Q	Gap R	Gap S	L1	L2	L3	L4
B	C	D	A				
D	B	A	C				

35. Gabriella sets up 2 circuits with an iron nail suspended at equal distance between two identical iron rods, X and Y. Both rods have an equal number of coils of wire around them.

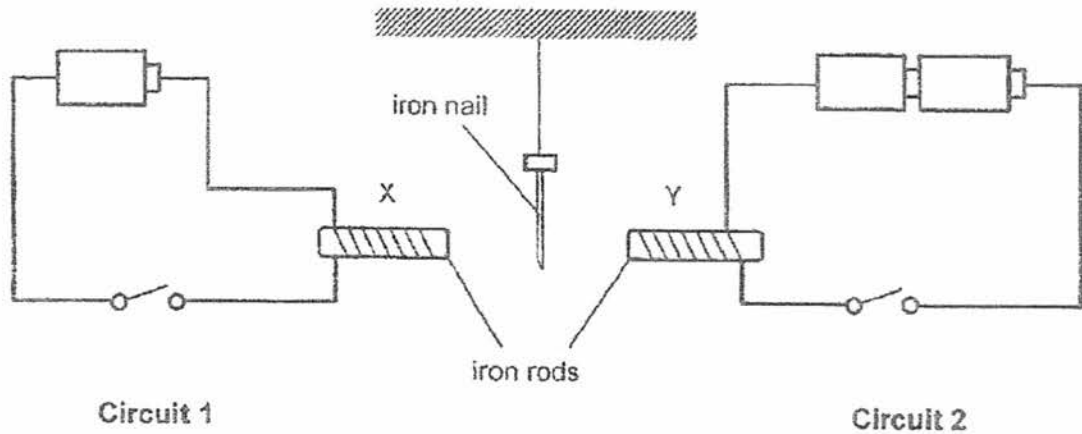

- (a) When only Circuit 1 is closed, what will happen to the iron nail ?

Circle the correct answer below. (1m)

Move towards X	Move towards Y	Stay at the same position
----------------	----------------	---------------------------

- (b) If both circuits are closed at the same time, what will happen to the iron nail?
Explain your answer. (2m)

- (c) When a copper nail is used instead, explain why it will remain at its original position? (1m)

36. Study the 3 circuits below carefully.

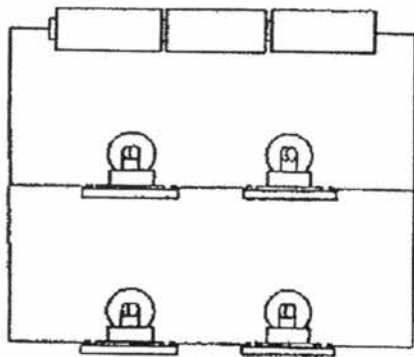

Circuit A

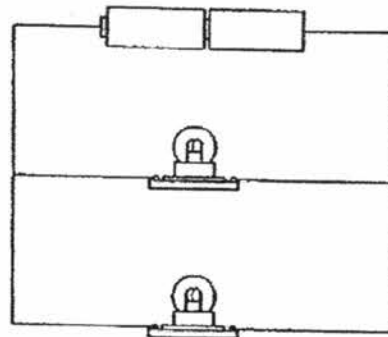

Circuit B

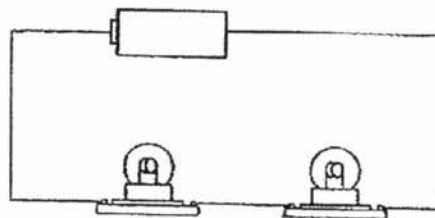

Circuit C

(a) The graph below shows how the arrangement of the bulbs in a circuit using similar batteries can affect the brightness of a bulb. Write "A", "B" and "C" in the correct boxes in the graph below. (2m)

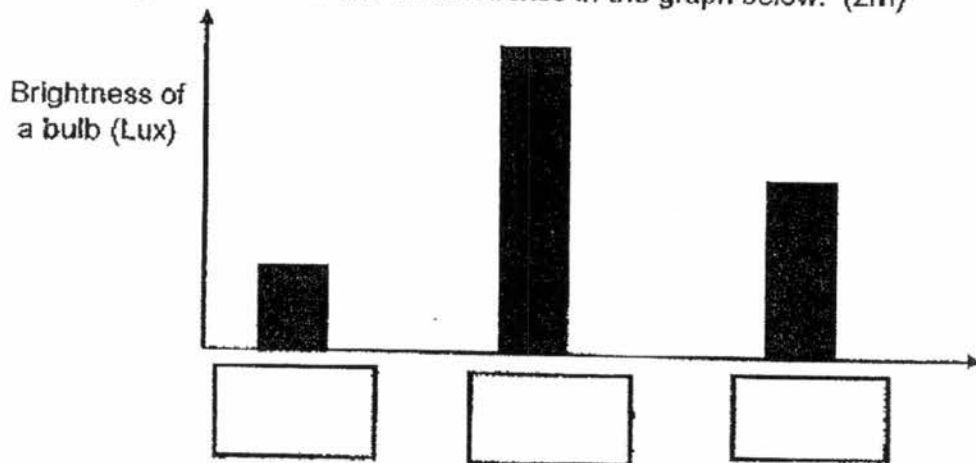

(b) If one of the bulbs in Circuit B fuses, will the other bulb still light up? Give a reason for your answer. (1m)

37. Selena wanted to find out the effect of overcrowding on plant growth. She placed all the pots at the same place and gave each pot the same amount of water each day. The table below shows the set-ups she had prepared.

Set-up	Number of plants	Types of soil	Size of pot
A	20	garden	big
B	10	garden	medium
C	20	loamy	small
D	10	garden	small
E	10	garden	big
F	10	loamy	medium

(a) Will Selena be able to make a conclusion on overcrowding if she compares Set-ups A and D? Explain. (1m)

(b) If Selena wants to find out which type of soil is better for plant growth, which 2 set-ups should she use? (1m)

(c) In which pot, A or E, will the plants be healthier? Give a reason for your answer. (1m)

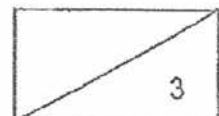

38. Tea at 90°C was poured into 2 similar cups made of Material C and D respectively. The cups were left on the table to cool down. The temperatures of the tea in both cups were recorded every 5 minutes and a graph was then plotted as shown below.

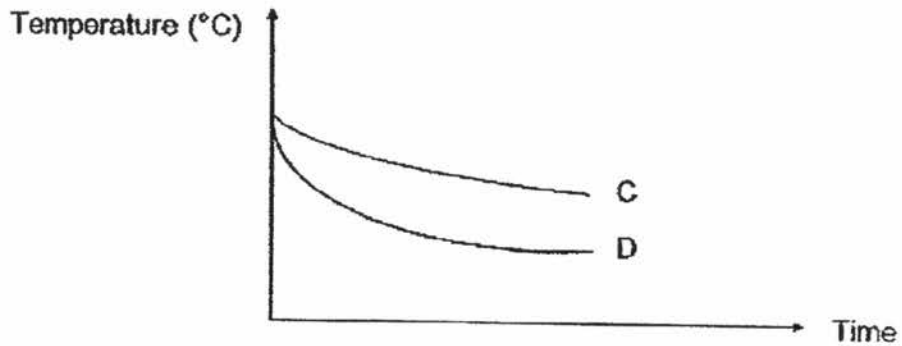

- (a) Explain why the tea in D cooled down faster. (1m)

-
- (b) Mrs Lim placed a mat below the hot pan so that the hot pan will not burn her table.

Which material, C or D, should she choose to use as a mat? Fill in the blanks below. (2m)

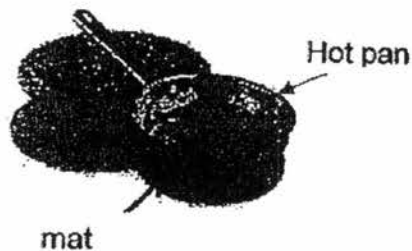

She should choose Material _____ because it is a _____ conductor of heat than Material _____ so it will conduct heat from the hot pan to the table _____.

38(c) Jonathan set up the experiment below using four different materials, P, Q, R and S.

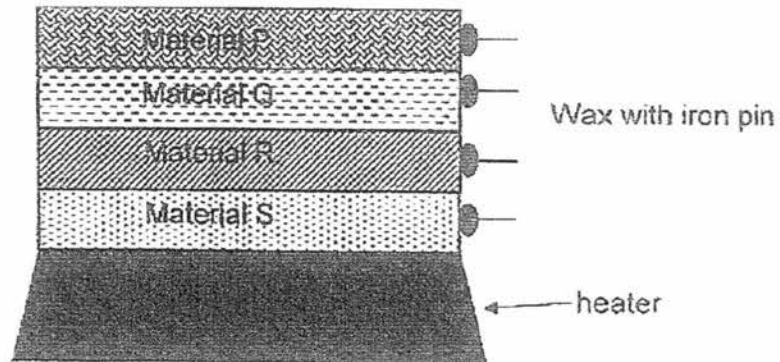

He recorded the results of his experiment in the table below.

Material	Time taken for the iron pin to drop (min)
P	13
Q	9
R	16
S	2

(i) One of the results above is wrong. Which result is wrong? Explain your answer. (2m)

39. The diagram below shows parts of the reproductive system of a human being.

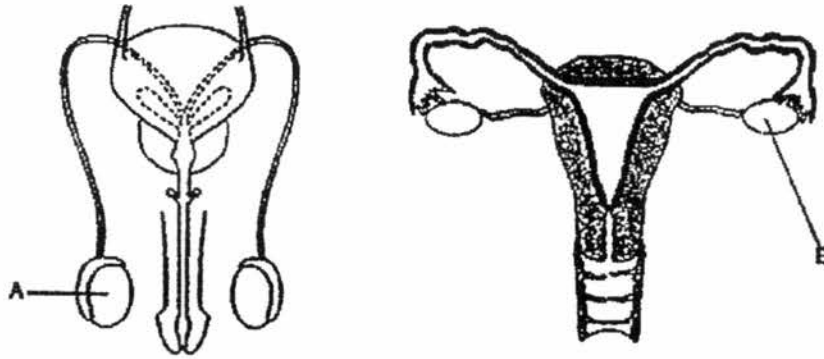

Male and Female human reproductive system

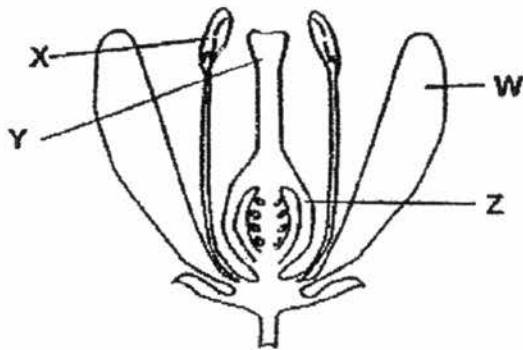

Reproductive system of a plant

(a) Identify the parts, W, X, Y or Z which has the similar function as

Part A: _____

Part B: _____



39. Jenny carried out an experiment with 3 brightly-coloured flowers, A, B and C, from the same plant. She removed a certain part from each flower as shown below.

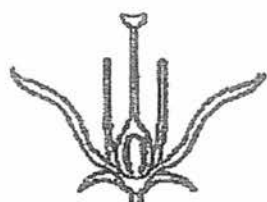

Flower A
anther removed

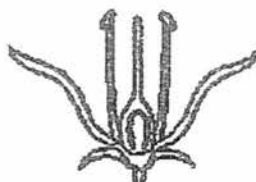

Flower B
stigma removed



Flower C
petals removed

- (b) Jenny then dusted pollen grains on the top of each flower. Which flowers A, B or C would not be able to bear fruit? Explain your answer. (2m)

- (c) Which flower is most likely to have the least number of insects attracted to it. Explain your answer. (1m)

40. Andrew wanted to prove to his friend, Nathan, that plants produce carbon dioxide when they respire. He prepared Set-up X for his experiment. Nathan told Andrew that he needed to have a control set-up for his experiment. Both set-ups were left in a dark room for 2 days.

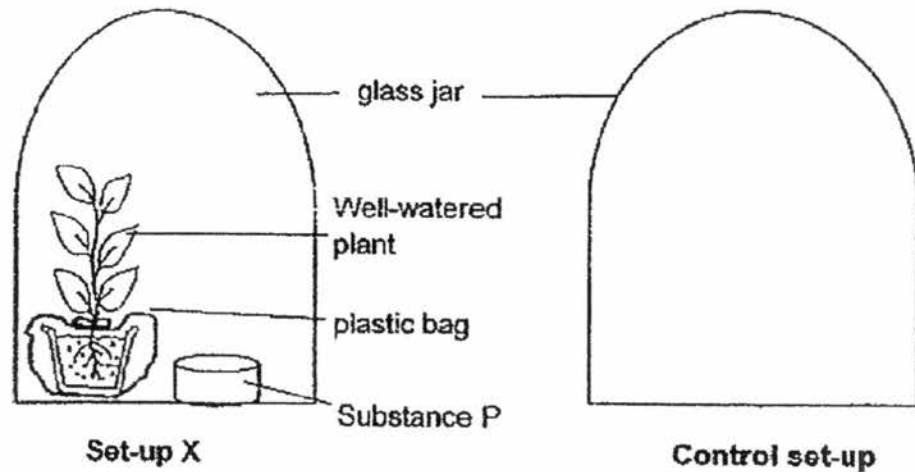

Substance P

- Remains colourless without carbon dioxide
- Turns pink with carbon dioxide

- (a) Draw and label the control set-up that Andrew needs to set up in the space shown above. (2m)
- (b) Why did Andrew have to place the set-ups for his experiment in a dark room for two days? (1m)
-
- (c) What observation would Andrew need to make in order to draw his conclusion for this experiment? (1m)
-

----- END OF BOOKLET B -----

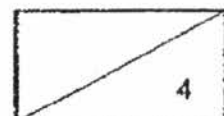

SINGAPORE CHINESE GIRLS' SCHOOL
PRIMARY 5 SCIENCE SA2 2017

Booklet A

1) 2	6) 3	11) 2	16) 4	21) 1	26) 3
2) 2	7) 1	12) 3	17) 2	22) 2	27) 4
3) 1	8) 1	13) 1	18) 3	23) 4	28) 4
4) 3	9) 3	14) 1	19) 2	24) 3	
5) 4	10) 3	15) 2	20) 1	25) 4	

Booklet B

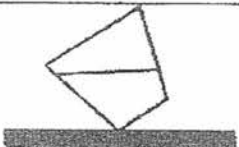
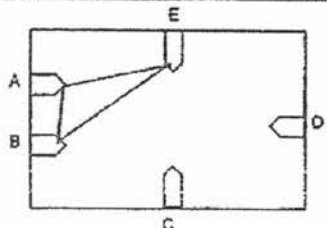
Qn	Suggested Answer																																
29a	A and C, air can be compressed																																
29b	B, water cannot be compressed																																
30a	False, Not possible to tell, Not possible to tell, True																																
30b																																	
31a	Amount of light reflected by the material																																
31b	Distance between light sensor and materials Light intensity from the light source																																
31c	A. A can reflect the highest amount of light at the furthest distance.																																
32a	Any temperature from 61°C to 100°C.																																
32b	Lid is cooler in X than in Y so water vapour can lose heat faster to the lid to condense into more water droplets.																																
33a	The temperature of barley drink decreased. The hot barley drink lost heat to the basin of ice water.																																
33b	Crushed ice has more contact area/exposed surface area with the drink so the drink can lose heat faster.																																
34a	 <p>(Any 2 lines)</p>																																
34b	Conductors of electricity: <u>B and C</u> Non-conductors of electricity: <u>A and D</u>																																
34c	<table border="1"> <thead> <tr> <th colspan="4">Position of rod</th> <th colspan="4">Light bulb(s) that lit up</th> </tr> <tr> <th>P</th> <th>Q</th> <th>R</th> <th>S</th> <th>L1</th> <th>L2</th> <th>L3</th> <th>L4</th> </tr> </thead> <tbody> <tr> <td>B</td> <td>C</td> <td>D</td> <td>A</td> <td>X</td> <td>X</td> <td>X</td> <td>X</td> </tr> <tr> <td>D</td> <td>B</td> <td>A</td> <td>C</td> <td>X</td> <td>√</td> <td>X</td> <td>√</td> </tr> </tbody> </table>	Position of rod				Light bulb(s) that lit up				P	Q	R	S	L1	L2	L3	L4	B	C	D	A	X	X	X	X	D	B	A	C	X	√	X	√
Position of rod				Light bulb(s) that lit up																													
P	Q	R	S	L1	L2	L3	L4																										
B	C	D	A	X	X	X	X																										
D	B	A	C	X	√	X	√																										

35a	Move towards X
35b	Attracted to Y. Y is a stronger magnet as circuit 2 has more batteries.
35c	Copper is a non-magnetic material.
36a	<p>A bar chart with the y-axis labeled 'Brightness of a bulb (Lux)'. The x-axis has three categories labeled 'C', 'B', and 'A'. The bar for 'B' is the tallest, followed by 'A', and 'C' is the shortest.</p>
36b	Yes. The bulbs are arranged in parallel so when one of the bulbs fuses, the remaining bulbs will light up as it is still a closed circuit.
37a	No. A has bigger pot / more space but more seeds than D or D has fewer seeds but a smaller pot / less space than A
37b	B and F
37c	Pot E. There was less competition for water, sunlight, space and mineral salts. / There was less overcrowding.
38a	Material D is a better conductor of heat than Material C.
38b	C, poorer, D, slower
38c	R. Since Material R is closer to the heater than Material Q and P, the pin at Material R should drop before the pins at Q and P.
39a	Part A : X Part B : Z
39b	Flower B. The stigma of Flower B was removed so pollination could not take place, thus fertilisation could not take place and it cannot bear fruit.
39c	Flower C. Flower C has no petals.
40a	A pot of soil covered with plastic bag and a container of Substance P. OR Just the container substance P.
40b	Prevent photosynthesis from taking place.
40c	Substance P turns pink.