

Name: _____ ()

Class: Primary 5 _____

CHIJ ST NICHOLAS GIRLS' SCHOOL (PRIMARY)



Primary 5 Mathematics

2019 End - Year Assessment

Paper 1

Booklet A

22 October 2019

**15 questions
20 marks**

Total Time for Booklets A and B: 1 hour

INSTRUCTIONS TO CANDIDATES

Do not turn over this page until you are told to do so.
Follow all instructions carefully.
Answer all questions.
Write your answers in this booklet.
The use of calculators is **NOT** allowed.

This booklet consists of 8 printed pages.

Questions 1 to 10 carry 1 mark each. Questions 11 to 15 carry 2 marks each. For each question, four options are given. One of them is the correct answer. Make your choice (1, 2, 3 or 4). Shade the correct oval (1, 2, 3, or 4) on the Optical Answer Sheet.

(20 marks)

1. Express 735 642 to the nearest thousand.

(1) 735 640

(2) 735 600

(3) 736 000

(4) 740 000

2. Express $\frac{8}{10} + \frac{19}{1000}$ as a decimal.

(1) 8.019

(2) 1.980

(3) 0.990

(4) 0.819

3. Which one of the following is bigger than $\frac{3}{4}$?

(1) $\frac{3}{9}$

(2) $\frac{4}{5}$

(3) $\frac{5}{8}$

(4) $\frac{9}{12}$

4. What is the product of 42 and $\frac{6}{7}$?

(1) 36

(2) 48

(3) 49

(4) 56

5. Samuel has 48 stickers. He has 12 fewer stickers than Lenny. Find the ratio of the number of stickers Samuel has to the total number of stickers both children have.

(1) 4 : 3

(2) 4 : 5

(3) 4 : 7

(4) 4 : 9

6. The figure below is made up of identical triangles. What percentage of the figure is shaded?

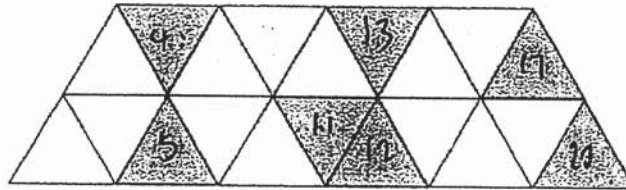

(1) 30%

(2) 35%

(3) 65%

(4) 70%

Use the graph below to answer questions 7 and 8.

The graph shows the number of rainy days per month from August to December.

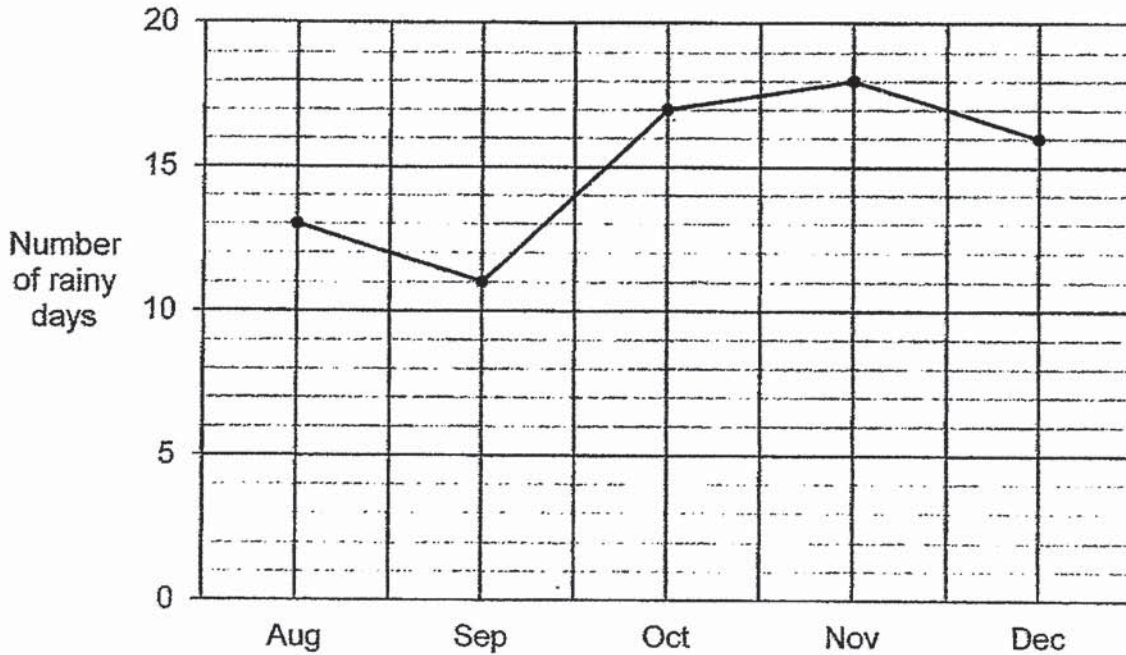

7. The average number of rainy days from August to December is 15. Which month has the number of rainy days closest to the average?

- (1) September
- (2) October
- (3) November
- (4) December

8. In which of the following periods did the number of rainy days increase the least?

- (1) August to September
- (2) September to October
- (3) October to November
- (4) November to December

9. The capacity of a container is 1050 ml. Express the capacity of the container in litres.

(1) 1.05 ℓ

(2) 1.5 ℓ

(3) 10.5 ℓ

(4) 10.05 ℓ

10. Which of the following statements best describe a trapezium?

A	All four sides are equal.
B	Only 1 pair of opposite sides is parallel.
C	Each pair of angles between the parallel sides adds up to 180° .
D	All angles are equal.

(1) A and C

(2) A and D

(3) B and C

(4) B and D

11. Ming bought 3 identical files and 3 identical notebooks from a bookshop. The 3 identical notebooks cost as much as 1 file. She paid \$24 altogether. How much did each file cost?

(1) \$4

(2) \$2

(3) \$6

(4) \$8

12. A bag contains 50 straws of two different colours. 10 straws are yellow and the rest are red. What percentage of the straws are red?

(1) 10 %

(2) 20 %

(3) 40 %

(4) 80 %

13. At a factory, a machine can print 900 labels in 30 s. At this rate, how many labels can the machine print in 2 min?

(1) 6000

(2) 3600

(3) 3000

(4) 1800

14. Miss Ong wants to pack 72 pears and 64 oranges into as many boxes as possible without any left over. Each box will have the same number of fruits. The number of pears in each box is the same. Find the number of pears in each box.

(1) 6

(2) 9

(3) 12

(4) 18

15. A jug can hold 2.5 l of orange juice when full. $\frac{3}{5}$ of the jug was filled with orange juice. Jennifer poured $\frac{1}{4}$ of the orange juice into some glasses. How much orange juice was left in the jug?

(1) 625 ml

(2) 875 ml

(3) 1125 ml

(4) 2250 ml

****End of Booklet A****

Name : _____ ()

Class : Primary 5 _____

CHIJ ST NICHOLAS GIRLS' SCHOOL (PRIMARY)



Primary 5 Mathematics

2019 End - Year Assessment

Paper 1

Booklet B

22 October 2019

Booklet A	20
Booklet B	25
Total (Paper 1)	45

Total time for booklets A and B : 1 hour

INSTRUCTIONS TO CANDIDATES

Do not turn over this page until you are told to do so.

Follow all instructions carefully.

Answer all questions.

Write your answers in this booklet

The use of calculators is **NOT** allowed.

This booklet consists of 11 printed pages.

Questions 16 to 20 carry 1 mark each. Show your working clearly and write your answers in the spaces provided. For questions which require units, give your answers in the units stated. (5 marks)

Do not write in this space

16. Form the smallest 5-digit odd number using all the digits below.

5	7	2	0	6
---	---	---	---	---

Ans : _____

17. $1.07 \times 900 =$ _____

Ans : _____

18. What is the missing number in the box?

$$\frac{38}{16} = 2 \frac{\boxed{?}}{8}$$

Ans : _____

19. Express 0.04 as a percentage.

Do not
write
in this
space

Ans : _____ %

20. The table shows the airmail charges between two countries. What is the airmail charge for sending a parcel that has a mass of 11 kg?

Mass Step Not Over	Airmail Charge
5 kg	\$30
10 kg	\$45
Per additional step of 1 kg	\$8

Ans : \$ _____

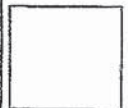

Questions 21 to 30 carry 2 marks each. Show your working clearly and write your answers in the spaces provided. For questions which require units, give your answers in the units stated. (20 marks)

Do not write in this space

21. The table shows the mass of 3 bags of onions.

Bag	Mass of Onions
A	3.86 kg
B	5.2 kg
C	?

The total mass of Bag A and Bag B is 4 times the mass of Bag C. Find the mass of Bag C.

Ans : _____ kg

22. The solid figure below is made up of identical cubes. Draw the front view of the solid figure in the square grid provided.

Do not write in this space

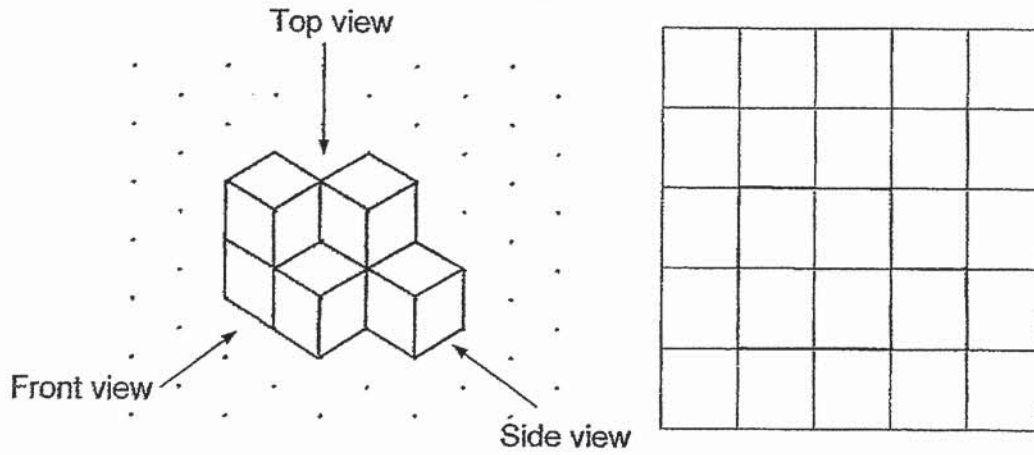

23. In the figure, RSTU is a rhombus and RT is a straight line. $\angle RTU = 47^\circ$. Find $\angle TUR$.

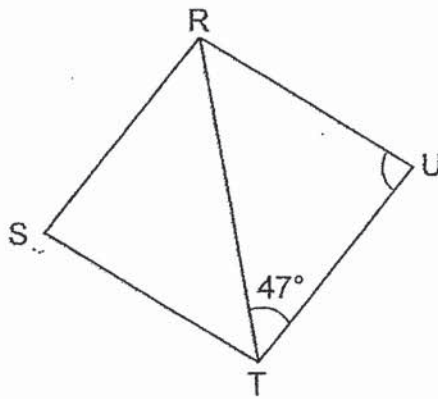

Ans : _____ °



24. In the figure, $\triangle XYN$ is an equilateral triangle and $\triangle LMN$ is an isosceles triangle. $LM = MN$ and $\angle YNM = 26^\circ$. Find $\angle LMN$.

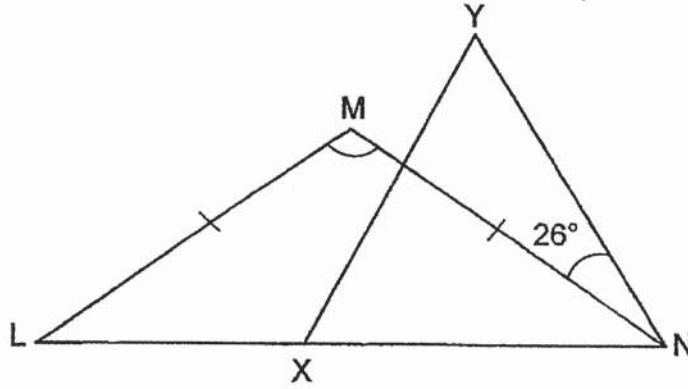

Do not
write
in this
space

Ans : _____ °

25. ABCD is a rectangle. The area of triangle ABE is 70 cm^2 and $BE = EC$. Find the area of the unshaded part AECD.

Do not write in this space

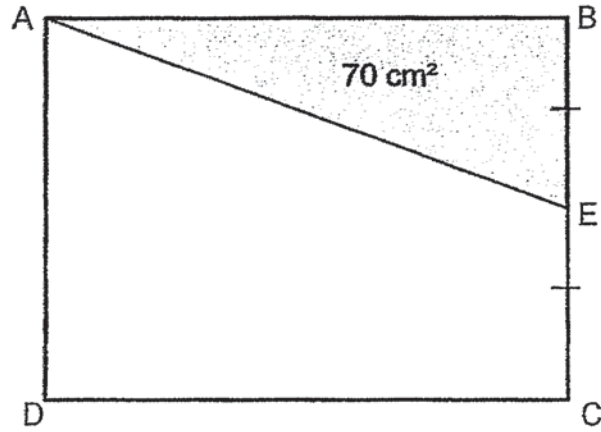

Ans : _____ cm^2

26. A box contained black, white and red paper clips. $\frac{1}{5}$ of them were black and $\frac{1}{2}$ of them were white. There was a total of 84 black and white paper clips. How many paper clips did the box contain?

Do not
write
in this
space

Ans : _____

27. There are altogether 29 boys and girls in Class 5A. On average, each pupil spent 5 hours playing computer games. The boys spent a total of 17 hours more than the girls playing computer games. Find the total number of hours the girls spent playing computer games.

Ans : _____ h

28. 7 identical squares are drawn within a rectangle as shown below. What is the ratio of the shaded parts to the unshaded parts?

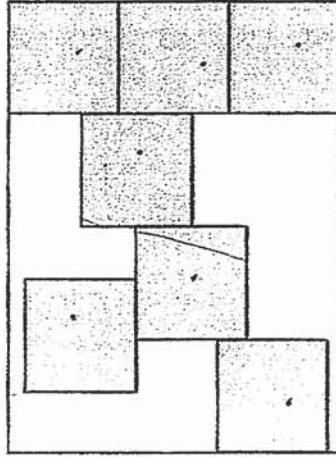

Do not
write
in this
space

Ans : _____

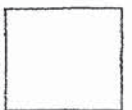

29. A table with 6 columns is filled with numbers in a certain pattern. The numbers continue in the same pattern. In which column will the number 46 appear?

Do not write in this space

A	B	C	D	E	F
		4	3	2	1
5	6	7	8		
		12	11	10	9
13	14	15	16		
		:	:		:
:	:	:	:		

Ans : _____

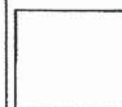

30. Mr Wong placed a total of 56 yellow cones and blue cones along a running track. A yellow cone is placed after every 7th blue cone. He placed a blue cone at the starting point.

Do not write in this space

Each statement below is either true, false or not possible to tell from the information given. For each statement, put a tick (✓) in the correct column.

Statement	True	False	Not possible to tell
The number of yellow cones was $\frac{1}{7}$ of the total number of cones.			
Among all the 56 cones placed along the running track, 49 were blue cones.			

End of Booklet B

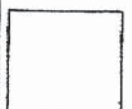

Name: _____ ()

Class: Primary 5 _____

CHIJ ST NICHOLAS GIRLS' SCHOOL (PRIMARY)



**Primary 5 Mathematics
2019 End - Year Assessment**

Paper 2

22 October 2019

Paper 1	45
Paper 2	55
Total Marks	100

Parent's/Guardian's Signature

Time : 1 hour 30 minutes

INSTRUCTIONS TO CANDIDATES

Do not turn over this page until you are told to do so.

Follow all instructions carefully.

Answer all questions.

Write your answers in this booklet

The use of an approved calculator is expected, where appropriate.

This booklet consists of 16 printed pages.

Questions 1 to 5 carry 2 marks each. Show your working clearly and write your answers in the spaces provided. For questions which require units, give your answers in the units stated. (10 marks)

Do not write in this space

1. Mr Jamal had a piece of wire. He used $4\frac{3}{4}$ m of the wire to form a rectangle. Then he used $1\frac{2}{5}$ m less than what was used for the rectangle to form a triangle. Find the total length of the wire he used. Leave your answer as a mixed number in its simplest form.

Ans : _____ m

2. Stella bought a refrigerator which included a 7% GST. The price of the refrigerator before GST was \$4390. How much did Stella pay for the refrigerator?

Ans : \$ _____



3. Lisa, Randy and Sami went on a cycling trip. Lisa cycled 0.9 km more than Sami. Randy cycled the same distance as Sami. The 3 children cycled 108 km altogether. What was the distance cycled by Randy?

Do not write in this space

Ans : _____ km _____ m

4. The figure below shows a triangle DEF. CDE is a straight line. $\angle DEF = 65^\circ$ and $\angle CDF = 131^\circ$. Find $\angle DFE$.

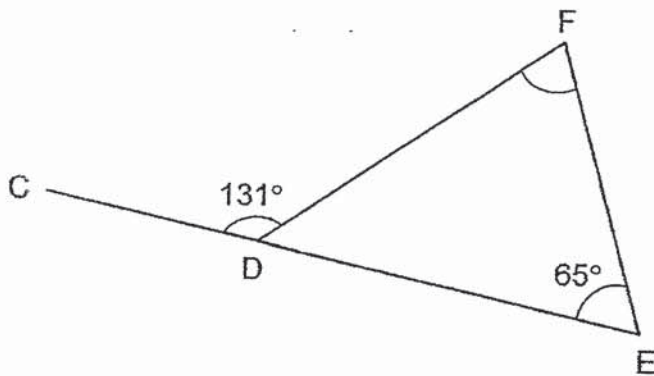

Ans : _____ °

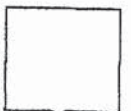

5. The Lim family used a total of 7.84 m^3 of water from Monday to Sunday. The water used is charged at \$1.25 per m^3 . What was the average amount of money the Lim family paid for the water used each day?

Do not
write in
this space

Ans : \$ _____

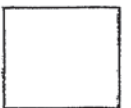

For questions 6 to 17, show your working clearly and write your answers in the spaces provided. The number of marks available is shown in the brackets () at the end of each question or part-question. (45 marks)

Do not write in this space

6. Kassim saved \$11.50 every month from January to May. Then he increased his savings by \$2.50 per month for the rest of the year. How much money did he save in the whole year?

Ans : _____ [3]

7. Peter and Osman were in the lift with some bags of cement. The greatest mass of the load the lift can take is 800 kg. The total mass of Peter and Osman was 152 kg. The mass of each bag of cement was 45 kg. With the 2 men inside the lift, what was the greatest number of bags of cement that could be placed in the lift?

Do not
write in
this space

Ans : _____ [3]

8. The table below shows the parking rates at a carpark.

Do not
write in
this space

Duration	Charges
First 2 hours	\$3.00
After the second hour	\$1.60 per $\frac{1}{2}$ hour or part thereof

Miss Song paid \$12.60 for her parking charges. What was the greatest number of hours she parked her car at the carpark?

Ans : _____ [3]

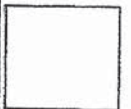

9. Lixin bought 12 boxes of pens and repacked them into 3 bundles in the ratio 9 : 1 : 5. Find the number of pens in the smallest bundle.

Do not write in this space

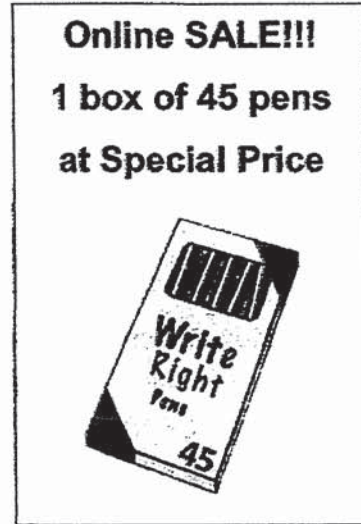

Ans : _____ [3]



10. In the figure PQRST, A and B are rectangles, C is a square and D is a triangle. Rectangle A has an area of 144 cm^2 and Rectangle B has an area of 108 cm^2 . Square C has an area of 81 cm^2 . $PT = 20 \text{ cm}$. What is the area of Triangle D?

Do not write in this space

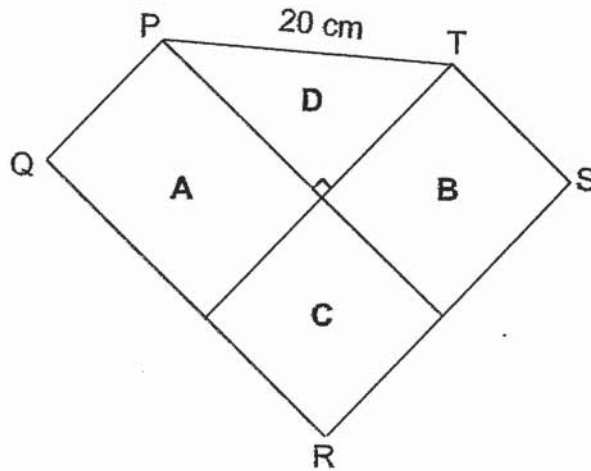

Ans : _____ [3]

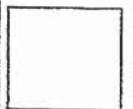

11. In the square grid below, XY is one side of an isosceles triangle XYZ and $XY = YZ$.

Do not write in this space

- (a) Draw and complete triangle XYZ from the given line XY .
Label the triangle XYZ .
- (b) Measure $\angle XYZ$.

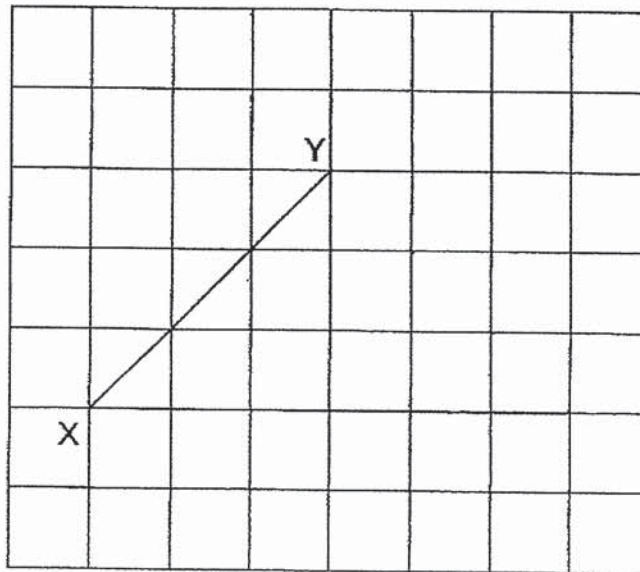

[2]

Ans : (b) _____ [1]

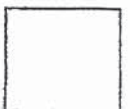

12. A total of 26 280 people took part in a walkathon. There were 5 times as many adults as children. When 30 women and 30 children withdrew from the walkathon, the number of women who took part was twice the number of children who took part. Find the number of men who took part in the walkathon.

Do not
write in
this space

Ans : _____ [4]

13. Vinita bought 12 adult tickets for a concert. Ning bought 8 adult tickets and 4 children tickets for the same concert. Each child ticket cost \$10.50. Altogether, Vinita spent \$31.60 more than Ning. How much money did Vinita and Ning spend altogether?

Do not
write in
this space

Ans : _____ [4]

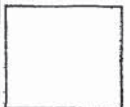

14. The bar graph below shows the number of packets of different food collected in a donation drive.

Do not write in this space

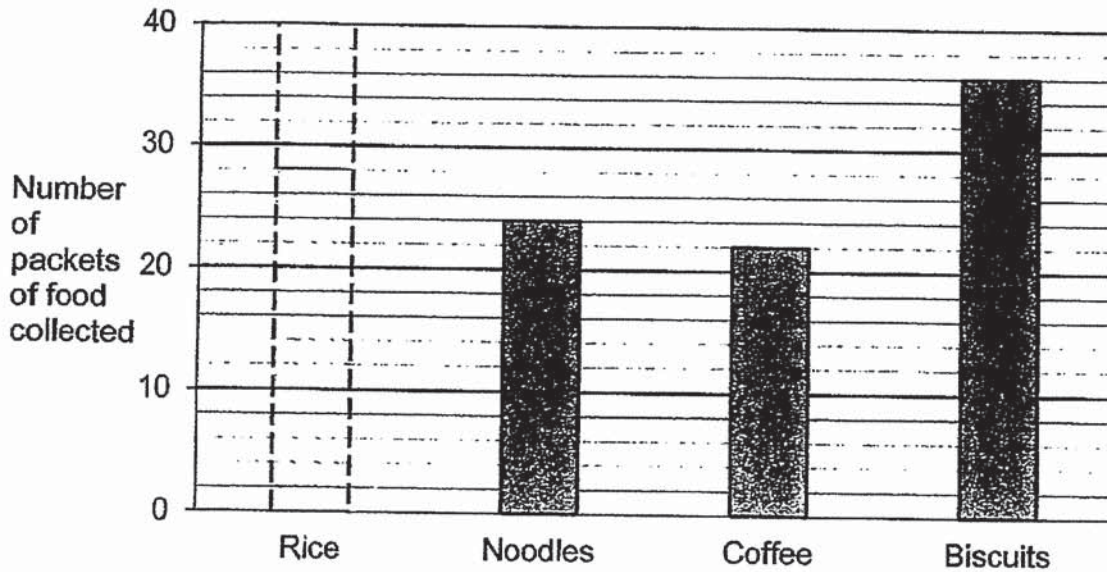

[2]

- (a) $\frac{1}{5}$ of the total number of packets of food collected was coffee. Draw the bar representing the number of packets of rice collected.
- (b) The table shows the mass of each packet of food.

Food Item	Mass of each packet
Rice	5 kg
Noodles	425 g
Coffee	525 g
Biscuits	300 g

What was the difference between the total mass of noodles collected and the total mass of biscuits collected?

Ans : (b) _____ [2]

15. A cubical tank of edge 30 cm contained some water to a height of 12 cm.

(a) Find the volume of water in the tank at first.

(b) A tap was then turned on for 20 minutes to fill the tank with water at a rate of 0.6 l per minute. How much more water was needed to fill the tank to the brim when the tap was turned off? Leave your answer in litres.

Do not
write in
this space

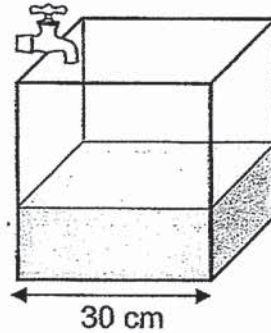

Ans : (a) _____ [1]

(b) _____ [4]

16. In the figure, JKLM is a parallelogram and LMNP is a trapezium. $\angle JKL = 106^\circ$ and $\angle JMN = 157^\circ$.

Do not
write in
this space

- (a) Name another line parallel to JK.
(b) Find $\angle KLM$.
(c) Find $\angle MNP$.

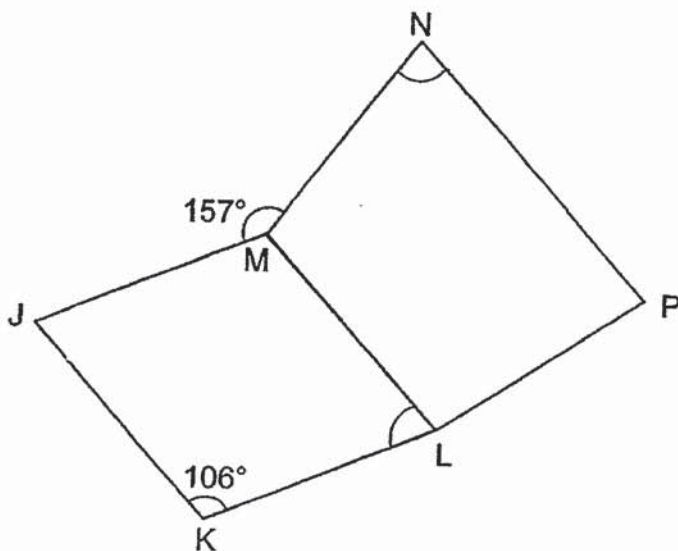

- Ans : (a) _____ [1]
(b) _____ [2]
(c) _____ [2]

17. Kavitha, Irene and Lyn shared a box of beads. Kavitha took $\frac{2}{7}$ of the beads and Irene took $\frac{3}{8}$ of the remaining beads. Lyn took 12 fewer beads than Irene. In the end, there were 52 beads left in the box. How many beads did the three girls take altogether?

Do not
write in
this space

Ans : _____ [5]

****End of Paper****

YEAR : **2019**
LEVEL : **PRIMARY 5**
SCHOOL : **CHIJ ST NICOHLAS GIRL'S SCHOOL**
SUBJECT : **MATHEMATICS**
TERM : **SEMESTRAL ASSESSMENT 2**

PAPER 1
BOOKLET A

Q1	Q2	Q3	Q4	Q5	Q6	Q7	Q8	Q9	Q10
3	4	2	1	4	2	4	3	1	3
Q11	Q12	Q13	Q14	Q15					
3	4	2	2	3					

BOOKLET B

- Q16. 20567
- Q17. 963
- Q18. 3
- Q19. 4%
- Q20. \$53
- Q21. 2.265 kg
- Q22.

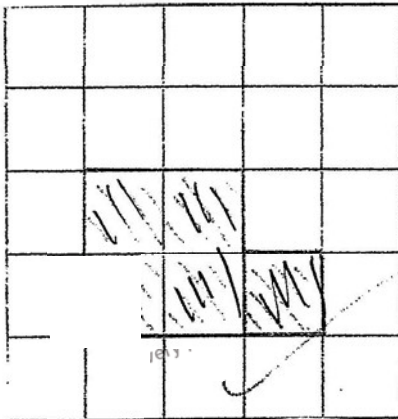

- Q23. 86°
- Q24. 112°
- Q25. 210 cm²
- Q26. 120 paperclips
- Q27. 64 h
- Q28. 7 : 5
- Q29. B

Q30.

True	False	Not possible to tell
	✓	
✓		

PAPER 2

Q1. $4\frac{3}{4} - 1\frac{2}{5} = 3\frac{7}{20}$
 $3\frac{7}{20} + 4\frac{3}{4} = 8\frac{1}{10}m$

Q2. $\$4390 \times 107\% = \4697.30

Q3. $108 - 0.9 = 107.1$
 $107.1 \div 3 = 35.7km$
 $35.7km = 35km\ 700m$

Q4. $180^\circ - 131^\circ = 49^\circ$
 $180^\circ - 49^\circ - 65^\circ = 66^\circ$

Q5. $7.84 \times \$1.25 = \9.80
 $\$9.80 \div 7 = \1.40

Q6. **From January to May,**
 $\$11.50 \times 5 = \57.50
 $\$11.50 + \$2.50 = \$14$
From June to December,
 $\$14 \times 7 = \98
 $\$57.50 + \$98 = \$155.50$

Q7. $800 - 152 = 648$
 $648 \div 45 = 14\ r\ 18kg$
 \therefore The greatest number of bags is 14.

Q8. $\$12.60 - \$3 = \$9.60$
 $\$9.60 \div \$1.60 = 6$
 $6 \times \frac{1}{2}h = 3h$
 $3h + 2h = 5h$

Q9. $12 \times 45 = 540$
 $9 + 1 + 5 = 15$
 $540 \div 15 = 36$

Q10. $\sqrt{81} = 9$
 $108 \div 9 = 12\text{cm}$
 $144 \div 9 = 16\text{cm}$
 $\frac{1}{2} \times 16 \times 12 = 96\text{cm}^2$

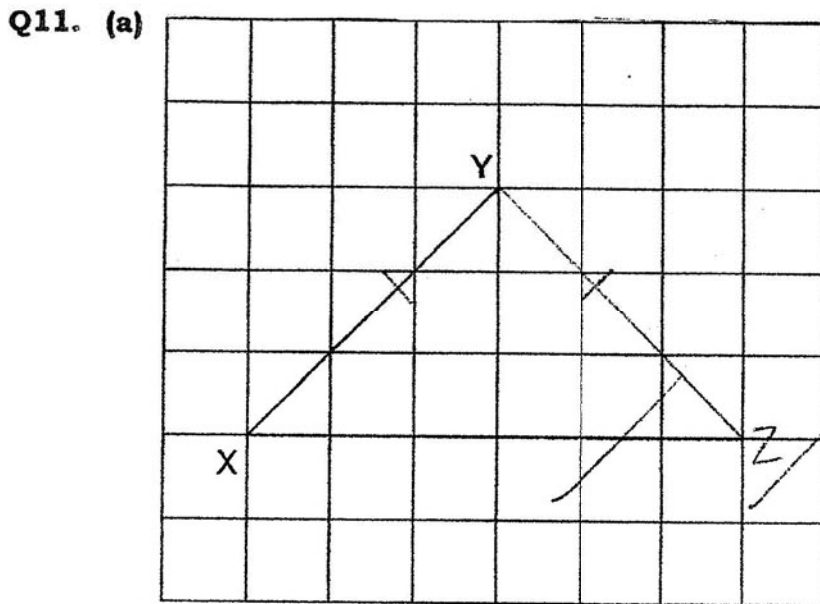

(b) 90°

Q12. No. of children $\rightarrow 26280 \div 6 = 4380$
 No. of adults $\rightarrow 4380 \times 5 = 21900$
 $4380 - 30 = 4350$
 $4350 \times 2 = 8700$
 No. of men $\rightarrow 21900 - 8700 - 30 = 13170$

Q13. $(4 \times \$10.50) + \$31.60 = \$73.60$
 $\$73.60 \div 4 = \18.40
 $(\$18.40 \times 20) + (\$10.50 \times 4) = \$410$

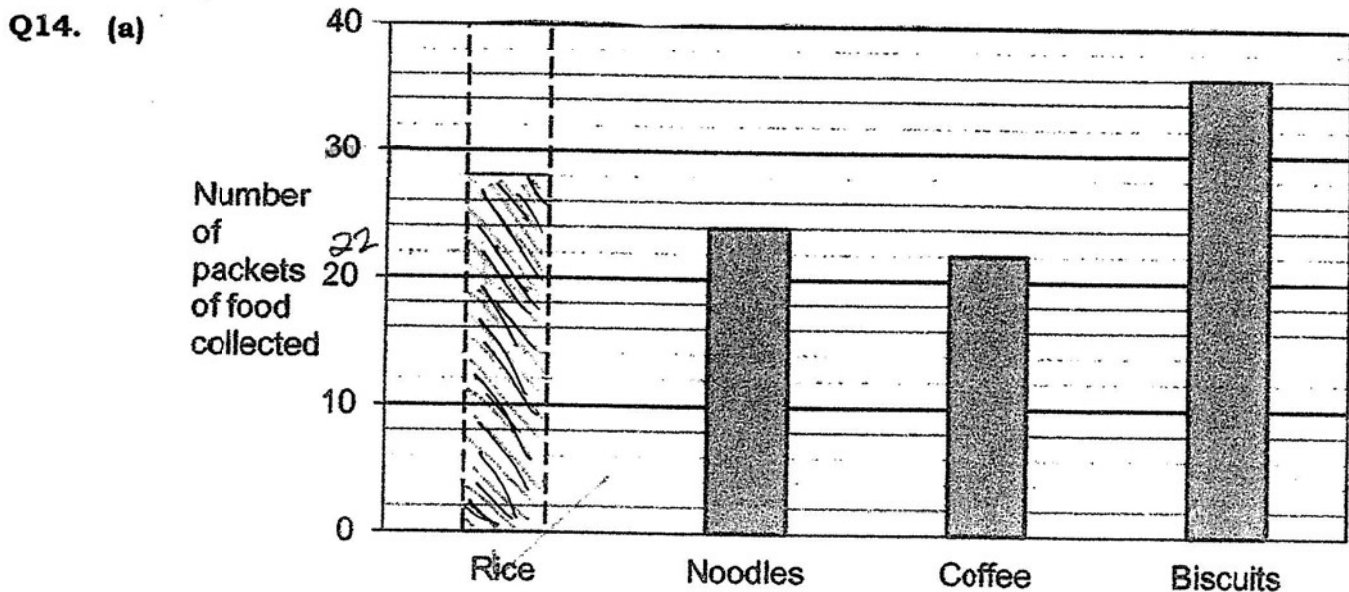

(b) $36 \times 300 = 10800$
 $24 \times 425 = 10200$
 $10800 - 10200 = 600\text{g}$

Q15. (a) $12 \times 30 \times 30 = 10800\text{cm}^2$
(b) $0.6 \times 20 = 12\text{l}$
 $10800\text{cm}^2 = 10.8\text{l}$
 $30 \times 30 \times 30 = 27000\text{cm}^2$
 $27000\text{cm}^2 = 27\text{l}$
 $27 - 12 - 10.8 = 4.2\text{l}$

Q16. (a) **Line ML**
(b) $360^\circ - 106^\circ - 106^\circ = 148^\circ$
 $148^\circ \div 2 = 74^\circ$
(c) $360^\circ - 106^\circ - 157^\circ = 97^\circ$
 $180^\circ - 97^\circ = 83^\circ$

Q17. $\frac{2}{8} \times \frac{5}{7} = \frac{5}{28}$
 $\frac{5}{28}$ of total $\rightarrow 52 - 12 = 40$
 $\frac{1}{28}$ of total $\rightarrow 40 \div 5 = 8$
 $8 \times 28 = 224$
 $224 - 52 = 172$

End.