



Maha Bodhi School
2022 Semestral Assessment 2
Primary 5
Mathematics
Paper 1
(Booklet A)

Name : _____ ()

Class : Primary 5 _____

Date : 27 October 2022

Total Time for Booklets A and B: 1 hour

INSTRUCTIONS TO CANDIDATES:

1. Do not turn over this page until you are told to do so.
2. Follow all instructions carefully.
3. Answer all questions.
4. Use a 2B pencil to shade your answers in the Optical Answer Sheet (OAS).
5. The use of calculators is **NOT** allowed.

This booklet consists of 5 printed pages.

Questions 1 to 10 carry 1 mark each. Questions 11 to 15 carry 2 marks each.
For each question, four options are given. One of them is the correct answer.
Make your choice (1, 2, 3 or 4) and shade your answer on the Optical Answer Sheet.
(20 marks)

1. In the number 32 145, which digit is in the hundreds place?

- (1) 1
- (2) 2
- (3) 3
- (4) 4

2. Round 7 438 200 to the nearest thousand.

- (1) 7 430 000
- (2) 7 438 000
- (3) 7 439 000
- (4) 7 440 000

3. Express $5\frac{3}{20}$ as a decimal.

- (1) 5.3
- (2) 5.2
- (3) 5.15
- (4) 5.03

4. Which of the following is the same as 1007 cm?

- (1) 1.007 m
- (2) 1.7 m
- (3) 10.07 m
- (4) 100.7 m

5. ___ What is the mass of the durian.

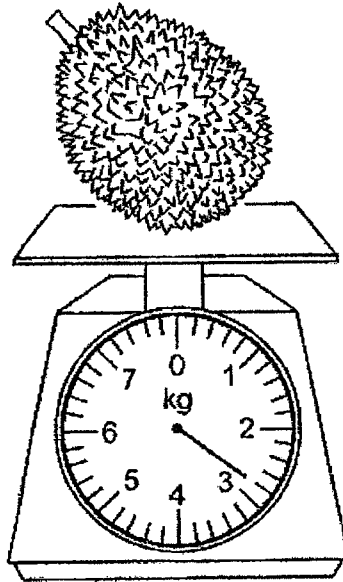

- (1) 2 kg 4 g
- (2) 2 kg 80 g
- (3) 2 kg 400 g
- (4) 2 kg 800 g

6. Which of the following shows the correct base and its corresponding height of triangle ABD?

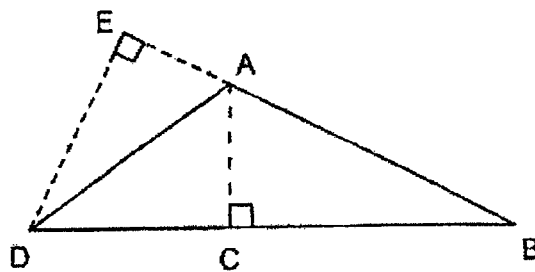

- | | Base | Corresponding height |
|-----|------|----------------------|
| (1) | EB | DE |
| (2) | AB | DE |
| (3) | BC | AC |
| (4) | DC | AC |

7. P, Q and R are three points on a square grid. Point Q is south of Point P.
Point R is _____ of Point Q.

- (1) South-East
(2) South-West
(3) North-East
(4) North-West

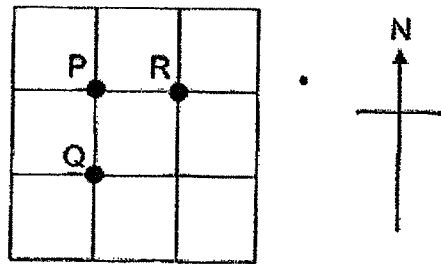

8. The table shows how much a shop charges for caps.

	Cost of each cap
First 10 caps	\$9 each
Every additional cap	\$8 each

Caylee bought 11 caps. How much did she pay?

- (1) \$88
(2) \$90
(3) \$98
(4) \$99
9. The masses of 3 boys are 25 kg, 29 kg and 36 kg. What is their average mass?
- (1) 18 kg
(2) 30 kg
(3) 90 kg
(4) 270 kg

10. In the number line, what is the value represented by A?

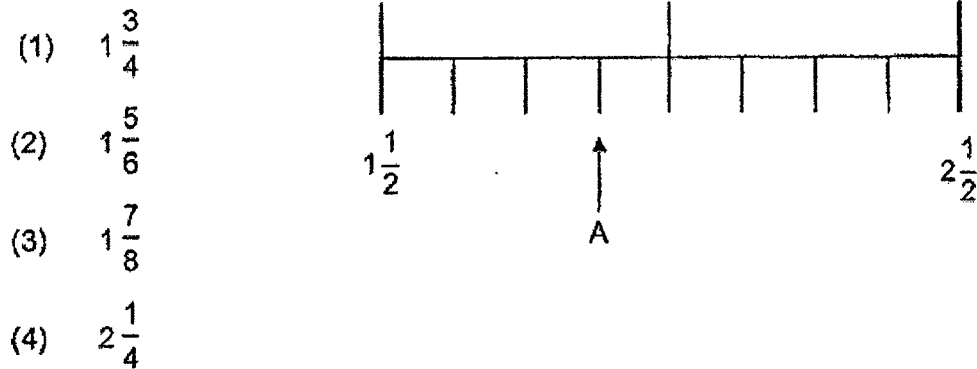

11. The figure below shows a rectangular tank containing some water. What is the volume of the water in the tank?

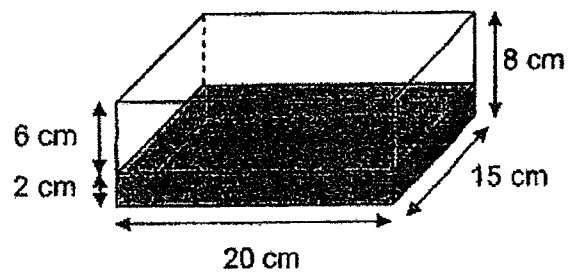

- (1) 2400 cm^3
- (2) 1800 cm^3
- (3) 600 cm^3
- (4) 300 cm^3
12. A toy shop was having a sale. The original price of 8 identical toy cars was \$120. How much would each toy car cost after a discount of 20%?
- (1) \$12
- (2) \$15
- (3) \$24
- (4) \$96

13. A surgical mask machine produces 50 masks in 5 minutes.
At this rate, how many hours are required to produce 6000 masks?
- (1) 6 hours
 - (2) 10 hours
 - (3) 24 hours
 - (4) 120 hours
14. Anna had a mix of twenty-cent and fifty-cent coins. Beth had only fifty-cent coins.
Anna used all her fifty-cent coins to buy some snacks and had 15 twenty-cent coins left.
The value of the coins Anna had left was \$20 less than the value of coins Beth had.
How many fifty-cent coins did Beth have?
- (1) 31
 - (2) 34
 - (3) 40
 - (4) 46
15. Janice obtains a total score of 146 points for her first two games. She wants to increase her average score by 5 points. How many points must she score for her next game?
- (1) 76
 - (2) 78
 - (3) 80
 - (4) 88



Remember to check your work!
~ End of Booklet A ~



Maha Bodhi School
2022 Semestral Assessment 2
Primary 5
Mathematics
Paper 1
(Booklet B)

Name : _____ ()

Marks:

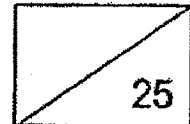

Class : Primary 5 _____

Date : 27 October 2022

Total Time for Booklets A and B: 1 hour

INSTRUCTIONS TO CANDIDATES:

1. Do not turn over this page until you are told to do so.
2. Follow all instructions carefully.
3. Answer all questions:
4. Write all your answers in this booklet.
5. The use of calculators is **NOT** allowed.

This booklet consists of 6 printed pages.

Questions 16 to 20 carry 1 mark each. Write your answers in the spaces provided.
For questions which require units, give your answers in the units stated. (5 marks)

16. What is the volume of the cube?

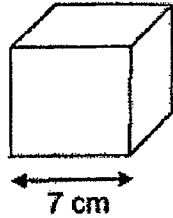

Ans: _____ cm³

17. The figure below is made up of identical squares.
Shade two more squares so that AB is the line of symmetry of the figure.

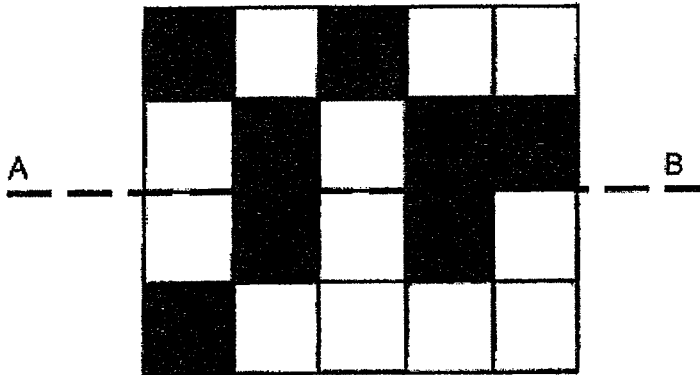

18. ABC is an isosceles triangle. Find $\angle x$.

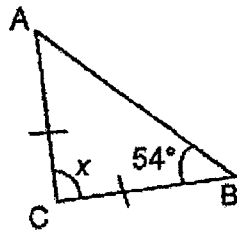

Ans: _____ °

19. The table shows the local postage rates for sending packages within Singapore.

Mass step not over	Postage
30 g	\$0.60
80 g	\$0.90
200 g	\$1.30
300 g	\$1.50

Emily sent two packages. One has a mass of 35 g and the other has a mass of 220 g. How much postage did Emily pay altogether?

Ans: \$ _____

20. Joey made an average of 20 paper cranes daily. How many paper cranes would she make in 4 weeks?

Ans: _____

Questions 21 to 30 carry 2 marks each. Show your working clearly in the space below each question and write your answers in the spaces provided.
For questions which require units, give your answers in the units stated. (20 marks)

21. Find the value of $48 - 6 \div 2 \times (5 + 6)$.

Ans: _____

22. Find the value of $3\frac{2}{3} - 1\frac{4}{5}$

Give your answer as a mixed number in the simplest form.

Ans: _____

23. Mrs Tan bought apples from the supermarket as shown below.
How much would she pay for 30 apples?



5 apples for \$3.45

Ans: \$ _____

24. Mother put an apple pie into the oven to bake at 7.30 a.m. The pie took $\frac{3}{4}$ h to bake.
At what time was the pie ready?

Ans: _____ a.m.

25. There are 45 cookies in a box. 27 of them are chocolate cookies while the rest are butter cookies. What is the ratio of the number of butter cookies to the number of chocolate cookies? Give your answer in the simplest form.

Ans: _____

26. Andy recorded the number of books he read over 4 weeks as shown below.

Week	Number of books
1	9
2	5
3	7
4	11

What was the average number of books he read in a week over the 4 weeks?

Ans: _____

27. Raju packed 16.8 kg of sugar into packets of 500 g and packets of 400 g. There were 20 packets of 500 g of sugar. How many packets of 400 g of sugar did Raju pack?

Ans: _____

28. The diagram below shows a square and a rectangle. The square has the same area as the rectangle. What is the length of the rectangle?

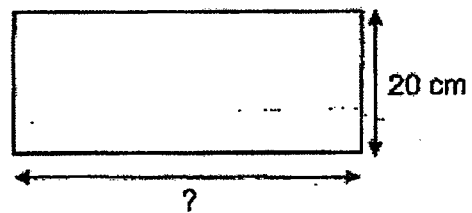
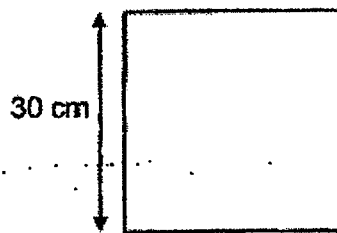

Ans: _____ cm

29. The difference between two numbers is 532. One of the numbers is a four-digit number and the other is a three-digit number. What is the smallest possible sum of the two numbers?

Ans: _____

30. In the diagram below, WXYZ is a rhombus. What is the difference between $\angle a$ and $\angle b$?

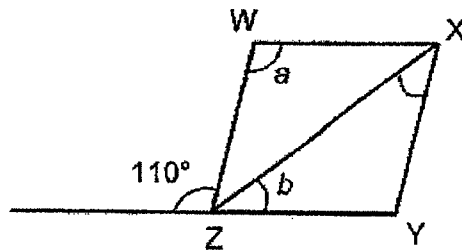

Ans: _____°

14



Remember to check your work!
~ End of Booklet B ~



Maha Bodhi School
2022 Semestral Assessment 2
Primary 5
Mathematics
Paper 2

Name : _____ ()

Class : Primary 5 _____

Date : 27 October 2022

Time: 1 h 30 min

INSTRUCTIONS TO CANDIDATES:

1. Do not turn over this page until you are told to do so.
2. Follow all instructions carefully.
3. Answer all questions.
4. Write your answers in this booklet.
5. The use of an approved calculator is allowed.

Paper	Booklet	Marks Obtained	Max Marks
1	A		20
	B		25
2	-		55
Total			100

Parent's signature: _____

This booklet consists of 13 printed pages.

Questions 1 to 5 carry 2 marks each. Show your working clearly in the space provided for each question and write your answers in the spaces provided. For questions which require units, give your answers in the units stated. (10 marks)

1. The figure below shows 5 identical squares.



What percentage of the figure is shaded?

Ans: _____ %

2. James prepared slices of mini cakes to be served during a party. When he gives 7 slices to each guest, he will have 2 slices left. When he gives 3 slices to each guest, he will have 134 slices left. How many guests were at the party?

Ans: _____

3. Siti bought 3 chicken wings and 2 curry puff at \$9.90. Judy bought 1 chicken wing and 1 curry puff at \$3.90. What is the price of 1 chicken wing?

Ans: \$ _____

4. At first, three beakers contained some water as shown below. Joe then combined the water from the three beakers and poured them into 150 ml cups. How many 150 ml cups can he fill completely?

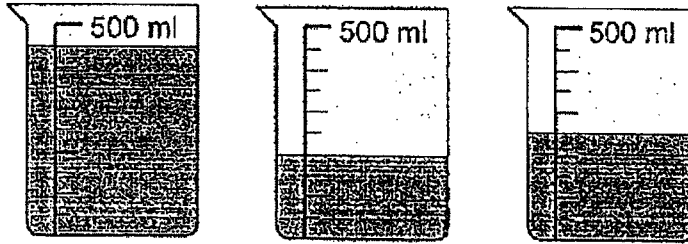

Ans: _____

5. The table below shows the wages of a part-time waiter in a cafeteria.

Time	Wages (Weekday)	Wages (Weekend)
First 8 hours	\$11 per hour	\$16 per hour
Subsequent hours	\$18 per hour	\$24 per hour

David worked for 10 hours on a Friday and 7 hours on a Saturday. How much did he earn?

Ans: \$ _____

For questions 6 to 17, show your working clearly in the space provided for each question and write your answers in the spaces provided. The number of marks available is shown in brackets [] at the end of each question or part-question. (45 marks)

6. In the figure below, $WXYZ$ is a square and VWX is an equilateral triangle. XUZ and VUW are straight lines.

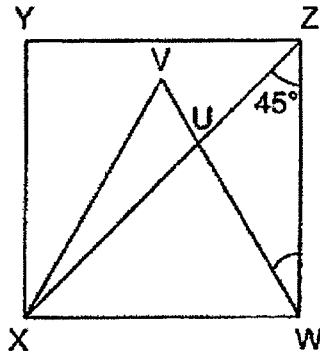

- (a) Find $\angle ZWU$.

Ans: (a) _____ [1]

- (b) Find $\angle XUW$.

Ans: (b) _____ [2]

7. Carol had 56 picture cards at first. After Carol gave $\frac{2}{7}$ of her picture cards to Bala, she had twice as many picture cards as Bala. How many picture cards did Bala have at first?

Ans: _____ [3]

8. In a box, there is a total of 105 red, green and blue balls. The ratio of the number of red balls to the number of green balls is 3 : 5. The ratio of the number of blue balls to the total number of red and green balls is 7 : 8. How many green balls are there?

Ans: _____ [3]

9. Mr Tan spent \$55 on a pair of shoes and 80% of his remaining money on a watch. He had \$48 left. How much money did he have at first?

Ans: _____ [3]

10. The first 20 numbers of a number pattern are given below.

3, 1, 8, 4, 5, 2, 3, 1, 8, 4, 5, 2, 3, 1, 8, 4, 5, 2, 3, 1,

(a) What is the 36th number?

Ans: (a) _____ [1]

(b) What is the sum of the first 127 numbers?

Ans: (b) _____ [3]

11. Mrs Lim and Mrs Wong each had some dough for making buns. Mrs Wong had _____ 1.2 kg more dough than Mrs Lim. The same mass of dough was used for each bun. Mrs Wong made 10 buns and had 2.3 kg of dough left. Mrs Lim made 40 buns and had 50 g of dough left. What was the mass of dough needed for each bun?

Ans: _____ [4]

12. In the figure below ABC is a triangle. ADC is a straight line. $AB = AD = BC$ and $\angle BCD = 34^\circ$.

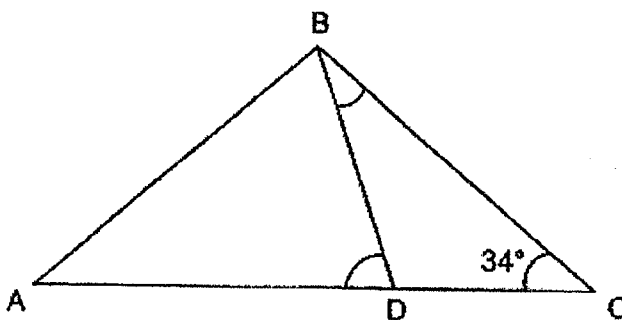

- (a) Find $\angle ADB$

Ans: (a) _____ [2]

- (b) Find $\angle DBC$

Ans: (b) _____ [2]

13. Travis received \$200 pocket money every month.
The graph below shows the amount of money he spent from January to May.

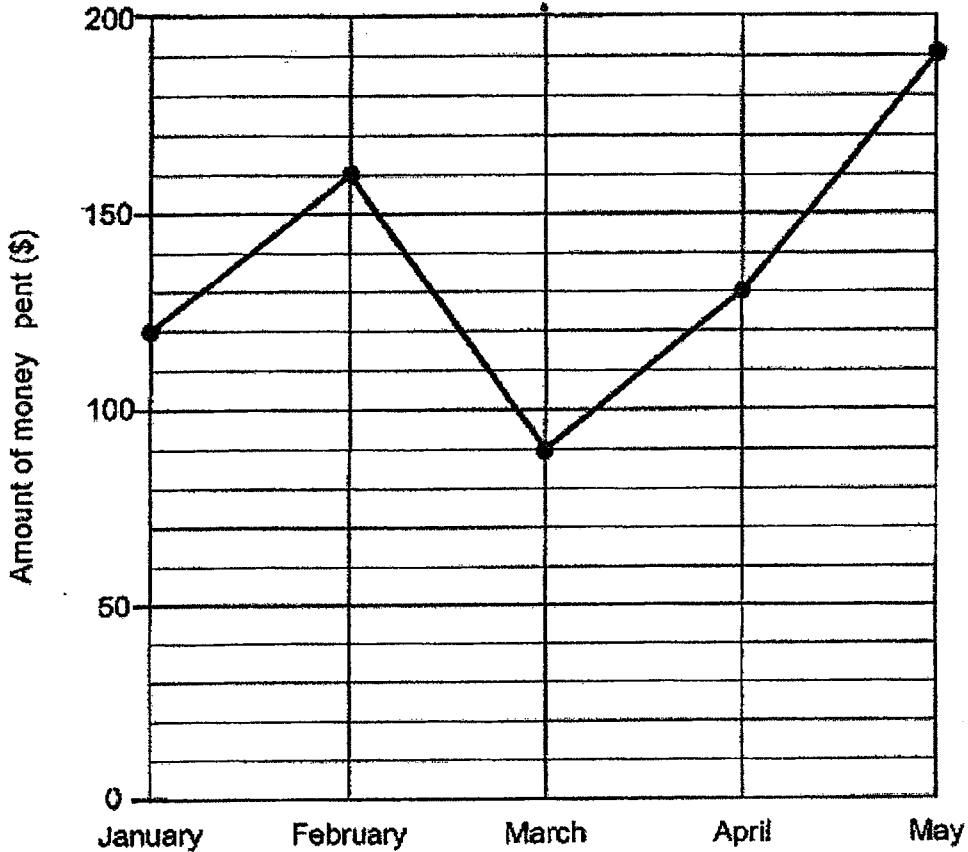

- (a) What is the total amount of money Travis spent January to May?

Ans: (a) _____ [2]

- (b) Every month, Travis's father would give him an additional \$30 to add on to his savings if he saved \$50 or more. How much would Travis save in total for the 5 months?

Ans: (b) _____ [2]

14. In the figure below, ABEF is a trapezium and ADE is a triangle.
 $AE = ED$ and FED is a straight line.

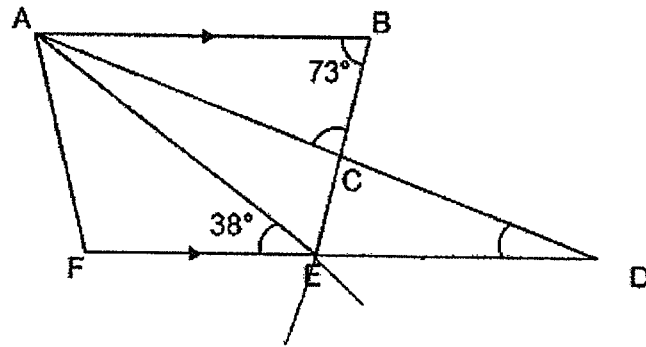

- (a) Find $\angle CDE$.

Ans: (a) _____ [1]

- (b) Find $\angle ACB$.

Ans: (b) _____ [2]

15. Figure 1 is made up of a square and a right-angled triangle. ZY is 8 cm longer than WX. Four of Figure 1 are used to form Figure 2. The perimeter of Figure 1 is 36 cm and the perimeter of Figure 2 is 108 cm. What is the area of Figure 2?

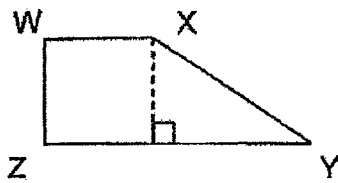

Figure 1

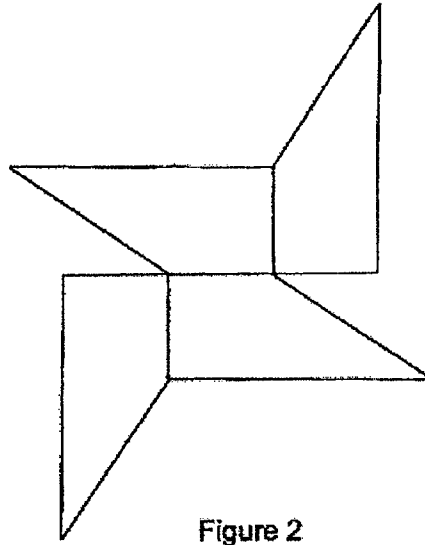

Figure 2

Ans: _____ [4]

16. The first four figures of a pattern are shown below.



Figure 1

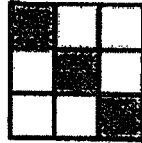

Figure 2

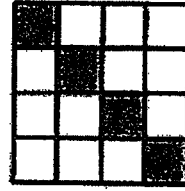

Figure 3

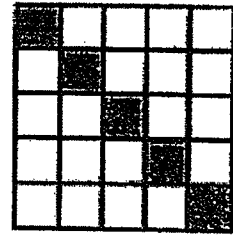

Figure 4

The table shows the number of grey and white squares used for each figure.

Figure Number	1	2	3	4	5
Number of grey squares	2	3	4	5	
Number of white squares	2	6	12	20	

[1]

- (a) Fill in the table for Figure 5.
- (b) A figure in the pattern has a total of 225 white and grey squares.
What is the Figure Number?

Ans: (b) Figure _____ [2]

- (c) What is the number of white squares in Figure 300?

Ans: (c) _____ [2]

17. At a fruit stall, mangoes, peaches and oranges are sold. There were 24 more mangoes than peaches at first. After $\frac{3}{5}$ of the mangoes, $\frac{5}{9}$ of the peaches and 22 oranges were sold, there was an equal number of each type of fruits left unsold.

(a) What was the total number of fruits left unsold?

Ans: (a) _____ [2]

- (b) Mangoes and oranges are sold for \$3.50 each. Each peach cost twice as much as each mango. How much money was collected from the sale of the fruits?

Ans: (b) _____ [3]



*Remember to check your work!
~ End of Paper ~*

SCHOOL : MAHA BODHI PRIMARY SCHOOL
 LEVEL : PRIMARY 5
 SUBJECT : MATHEMATICS
 TERM : 2022 SA2

PAPER 1 BOOKLET A

Q 1	Q2	Q3	Q4	Q5	Q6	Q7	Q8	Q9	Q10
1	2	3	3	4	2	3	3	2	3
Q 11	Q12	Q13	Q14	Q15					
3	1	2	4	4					

PAPER 1 BOOKLET B

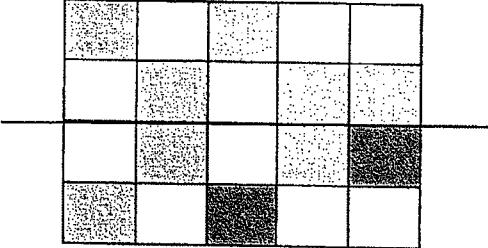
Q16)	$7 \times 7 \times 7 = 343 \text{cm}^3$
Q17)	
Q18)	$\angle X = 180^\circ - 54^\circ - 54^\circ = 72^\circ$
Q19)	$\$0.90 + \$1.50 = \$2.40$
Q20)	$4 \times 7 = 28$ $20 \times 28 = 560$
Q21)	$48 - 6 \div 2 \times (5 \times 6) = 48 - 6 \div 2 \times 11$ $= 48 - 3 \times 11$ $= 48 - 33 = 15$
Q22)	$3\frac{2}{3} - 1\frac{4}{5} = 3\frac{10}{15} - 1\frac{12}{15}$ $= 2\frac{25}{15} - 1\frac{12}{15}$ $= 1\frac{13}{15}$

Q23)	$30 \div 5 = 6$ $6 \times \$3.45 = \20.70
Q24)	8.15a.m.
Q25)	$45 - 27 = 18$ $18 : 27 = 6 : 9$ $= 2 : 3$
Q26)	$9 + 5 + 7 + 11 = 32$ $32 \div 4 = 8$
Q27)	$500\text{g} \times 20 = 10\text{kg}$ $16.8\text{kg} - 10\text{kg} = 6.8\text{kg} = 6800\text{g}$ $6800\text{g} \div 400\text{g} = 17$
Q28)	$30 \times 30 = 900\text{cm}^2$ $900\text{cm}^2 \div 20\text{cm} = 45\text{cm}$
Q29)	$1000 - 532 = 468$ $1000 + 468 = 1468$
Q30)	$\angle b = (180^\circ - 110^\circ) \div 2$ $= 35^\circ$ $\angle a = 180^\circ - 35^\circ - 35^\circ$ $= 110^\circ$ $\angle a - \angle b = 110^\circ - 35^\circ$ $= 75^\circ$

PAPER 2

Q1)	$\frac{1}{5} = 0.2$ $= 20\%$
Q2)	$134 - 2 = 132$ $7 - 3 = 4$ $132 \div 4 = 33$
Q3)	$2\text{cw} + 1\text{cp} \rightarrow \$9.90 - \$3.90 = \6 $1\text{cw} \rightarrow \$6 - \$3.90 = \$2.10$
Q4)	$450\text{ml} + 200\text{ml} + 250\text{ml} = 900\text{ml}$ $900\text{ml} \div 150\text{ml} = 6$
Q5)	$\$11 \times 8 = \88 $\$18 \times 2 = \36 $\$36 + \$88 = \$124$ $\$16 \times 7 = \112 $\$112 + \$124 = \$236$

Q6)	<p>a) $\angle XWV = 180^\circ \div 3$ $= 60^\circ$ $\angle ZWU = 90^\circ - 60^\circ$ $= 30^\circ$</p> <p>b) $\angle ZUW = 180^\circ - 30^\circ - 45^\circ$ $= 105^\circ$ $\angle XUV + \angle WUZ = 105^\circ \times 2$ $= 210^\circ$ $\angle XUW + \angle VUZ = 360^\circ - 210^\circ$ $= 150^\circ$ $\angle XUW = 150^\circ \div 2$ $= 75^\circ$</p>
Q7)	<p>$7u = 56$ $1u = 56 \div 7 = 8$ $2u = 8 \times 2 = 16$ $5u = 8 \times 5 = 40$ $40 \div 2 = 20$ $20 - 16 = 4$</p>
Q8)	<p>$7 + 3 + 5 = 15$ $15u = 105$ $1u = 105 \div 15 = 7$ $5u = 7 \times 5 = 35$</p>
Q9)	<p>$48 \div 20 = 2.40$ $2.40 \times 100 = 240$ $240 + 55 = 295$</p>
Q10)	<p>a) 1set \rightarrow 6 numbers $36 \div 6 = 6$ the 6th number is 2</p> <p>b) $127 \div 6 \approx 21$ 1set total $\rightarrow 3 + 1 + 8 + 4 + 5 + 2 = 23$ $23 \times 21 = 483$ $21 \times 6 = 126$ $127 - 126 = 1$ $483 + 3 = 486$</p>
Q11)	<p>$2.3\text{kg} - 1.2\text{kg} = 1.1\text{kg} = 1100\text{g}$ 30buns $\rightarrow 1100 - 50 = 1050$ 1bun $\rightarrow 1050 \div 30 = 35\text{g}$</p>

Q12)	<p>a) $\angle ADB + \angle ABD = 180^\circ - 34^\circ = 146^\circ$ $\angle ADB = 146^\circ \div 2 = 73^\circ$</p> <p>b) $\angle ABC = 180^\circ - 34^\circ - 34^\circ$ $= 112^\circ$ $\angle DBC = 112^\circ - 73^\circ$ $= 39^\circ$</p>															
Q13)	<p>a) $\\$80 + \\$40 + \\$110 + \\$70 + \\$10 = \\310</p> <p>b) $\\$30 \times 3 = 90$ $310 + 90 = \\$400$</p>															
Q14)	<p>a) $\angle AED = 180^\circ - 38^\circ$ $= 142^\circ$ $\angle CDE = (180^\circ - 142^\circ) \div 2$ $= 19^\circ$</p> <p>b) $\angle AEC = 180^\circ - 38^\circ - 73^\circ$ $= 69^\circ$ $\angle ACE = 180^\circ - 69^\circ - 19^\circ$ $= 92^\circ$ $\angle ACB = 180^\circ - 92^\circ$ $= 88^\circ$</p>															
Q15)	<p>$36 - 8 = 28$ $36 \times 4 = 144$ $144 - 108 = 36$ $36 \div 6 = 6$ $6 \times 6 = 36$ $36 \times 4 = 144$ $\frac{1}{2} \times 8 \times 6 = 24$ $24 \times 4 = 96$ $96 + 144 = 240\text{cm}^2$</p>															
Q16)	<p>a)</p> <table border="1" data-bbox="454 1803 1268 1904"> <tbody> <tr> <td>1</td> <td>2</td> <td>3</td> <td>4</td> <td>5</td> </tr> <tr> <td>2</td> <td>3</td> <td>4</td> <td>5</td> <td>6</td> </tr> <tr> <td>2</td> <td>6</td> <td>12</td> <td>20</td> <td>30</td> </tr> </tbody> </table>	1	2	3	4	5	2	3	4	5	6	2	6	12	20	30
1	2	3	4	5												
2	3	4	5	6												
2	6	12	20	30												

	<p>b) $15 \times 15 = 225$ $15 - 1 = \text{Figure 14}$</p> <p>c) $300 \div 1 = 301$ $301 \times 301 = 90601$ $90601 - 301 = 90300$</p>
Q17)	<p>a) $1u = 24$ $4u = 24 \times 4 = 96$ $96 \times 3 = 288$</p> <p>b) $6u \times 24 \times 3.50 = \\504 $5u \times 24 \times \\$7 = \\840 $22 \times \\$3.50 = \\77 $\\$504 + 840 + \\$77 = 1421$</p>

