

NANYANG PRIMARY SCHOOL
PRIMARY 5 SCIENCE
SEMESTRAL ASSESSMENT 2
2019

BOOKLET A

Date : 22nd Oct 2019
Duration : 1 h 45 min

Name : _____ ()

Class: Primary 5 ()

**DO NOT OPEN THIS BOOKLET UNTIL YOU ARE TOLD TO DO SO.
FOLLOW ALL INSTRUCTIONS CAREFULLY.**

Booklet A consists of 18 printed pages including this cover page.

Section A (28 x 2 marks = 56 marks)

For each question from 1 to 28, four options are given. One of them is the correct answer. Make your choice (1, 2, 3 or 4). **Identify and shade the correct oval (1, 2, 3 or 4) on the Optical Answer Sheet provided.**

1. The diagrams below show the human and plant reproductive systems.

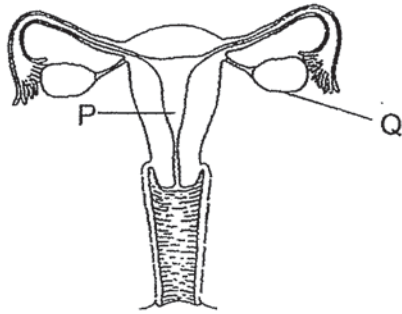

human reproductive system

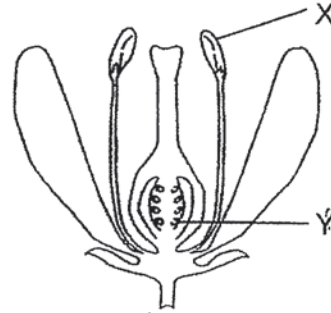

plant reproductive system

Which of the following statements are correct?

- A After fertilisation, the baby develops in part P.
- B Male reproductive cells are stored in parts Q and X.
- C Female reproductive cells are stored in parts Q and Y.

- (1) A and B only
- (2) A and C only
- (3) B and C only
- (4) A, B and C

2. Which of the following will not change when a child grows into an adult.

- A Height
- B Size of feet
- C Type of earlobe
- D Natural eye colour

- (1) A and B only
- (2) B and D only
- (3) C and D only
- (4) A, C and D only

3. Study the diagram below.

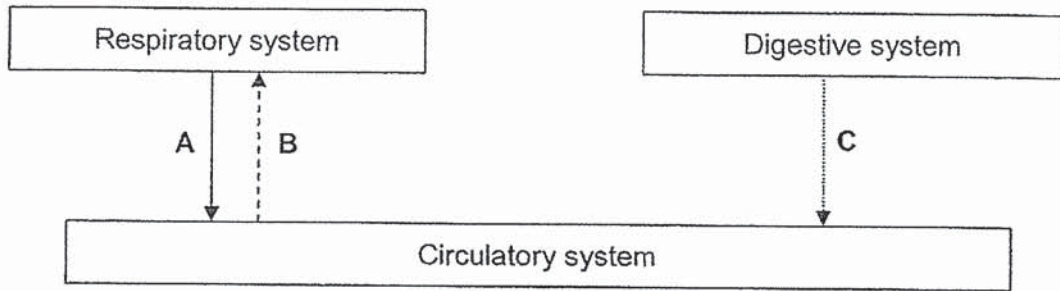

Based on the diagram above, which of the following is correct?

	A	B	C
(1)	oxygen	carbon dioxide	digested food
(2)	oxygen	carbon dioxide	undigested food
(3)	carbon dioxide	oxygen	digested food
(4)	carbon dioxide	oxygen	undigested food

4. Which of the following is correct about the organ systems in our body?

- (1) The circulatory system consists of the heart only.
- (2) The respiratory system only takes in carbon dioxide.
- (3) The skeletal system provides structural support for the body.
- (4) The muscular and skeletal systems are the only systems working together when we are swimming.

5. Study the diagram below.

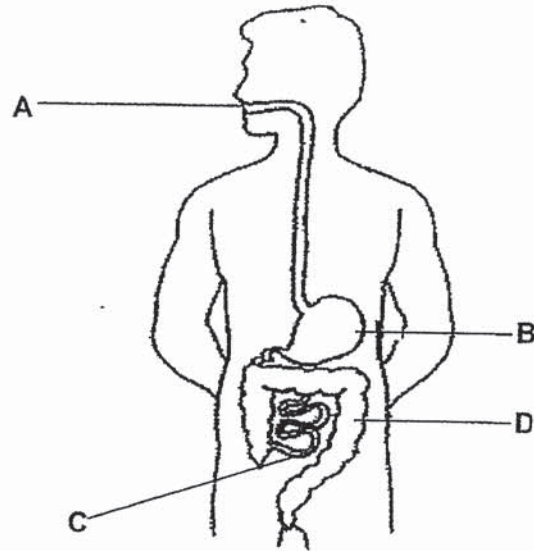

Which of the following is correct?

	Where digestion first takes place	Where digested food is absorbed
(1)	A	C
(2)	B	C
(3)	A	D
(4)	B	D

6. Study the diagram below.

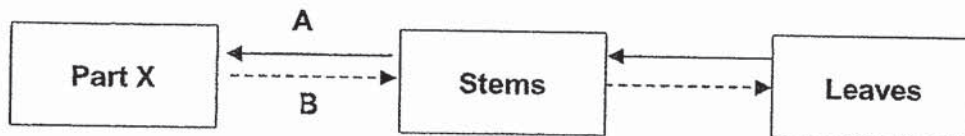

Based on the diagram above, which of the following is correct?

	Part X	A	B
(1)	roots	food	food
(2)	roots	food	water
(3)	fruits	water	food
(4)	fruits	water	water

7. The diagram below shows a cell with labelled parts A, B and C.

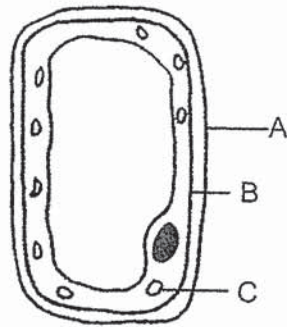

Which of the following correctly describes the functions of the labelled parts?

	Part A	Part B	Part C
(1)	allows only some substances to pass through	provides support for the cell	traps light for photosynthesis
(2)	gives the cell its shape	provides support for the cell	controls all activities in the cell
(3)	gives the cell its shape	controls movement of substances in and out of cell	traps light for photosynthesis
(4)	allows only some substances to pass through	controls movement of substances in and out of cell	controls all activities in the cell

8. Which of the following statements is definitely correct?

- (1) Mosquitoes lay eggs, but cockroaches do not
- (2) Mosquitoes spend its entire life cycle on land, but cockroaches do not.
- (3) Mosquitoes have a 3-stage life cycle, but cockroaches have a 4-stage life cycle.
- (4) The young of a mosquito does not look like the adult but the young of a cockroach looks like the adult.

9. Study the flowchart below carefully.

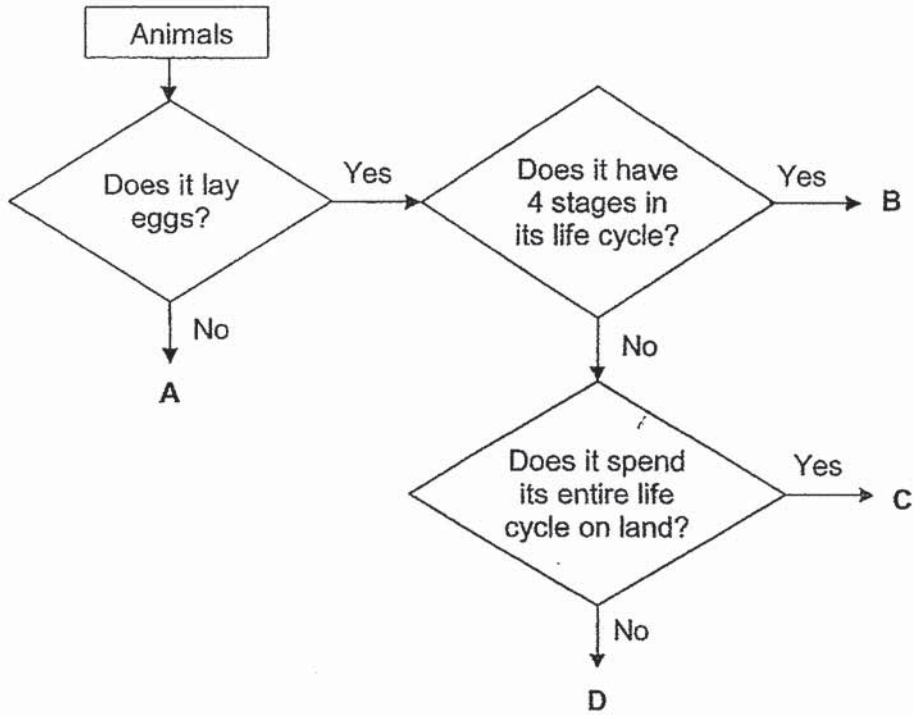

Based on the flowchart above, which animals do A, B, C and D represent?

	A	B	C	D
(1)	eagle	mosquito	elephant	beetle
(2)	rabbit	frog	mosquito	butterfly
(3)	elephant	butterfly	eagle	frog
(4)	rabbit	beetle	frog	eagle

10. The diagram below shows the different stages of development in the life cycle of a plant.

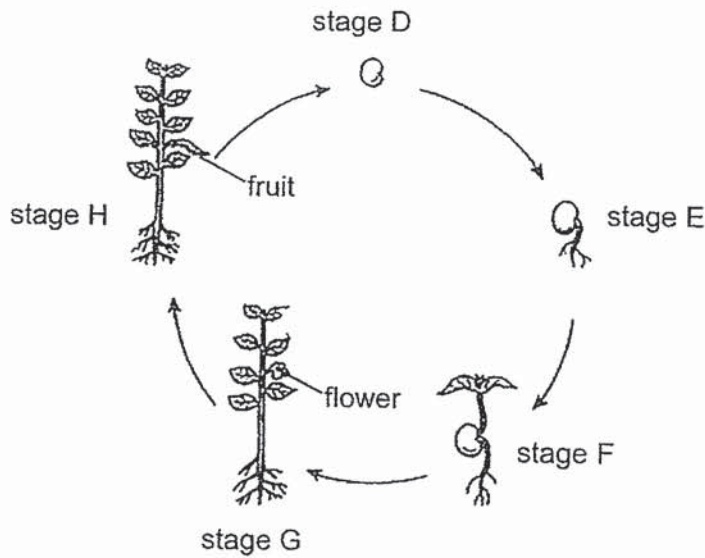

Which of the following statements is correct?

- (1) Fertilisation is taking place at stage D.
 - (2) Sunlight is not needed in all the 5 stages.
 - (3) The plant is able to reproduce in stage E only.
 - (4) The plant is able to make its own food in stages F, G and H.
11. Which of the following **does not** help to conserve water?
- (1) Take a longer shower on a hot day.
 - (2) Use a water-efficient washing machine.
 - (3) Use a pail of water instead of a hose to wash the car.
 - (4) Use water from washing vegetables to clean the toilet.

12. Lily took out three identical cups, X, Y and Z, from the refrigerator. The liquid in the three cups had similar temperature of 10°C . She then placed the cups at different locations with different temperatures. After 1 minute, she observed the amount of water droplets on the outer surface of the cups as shown in the diagram below.

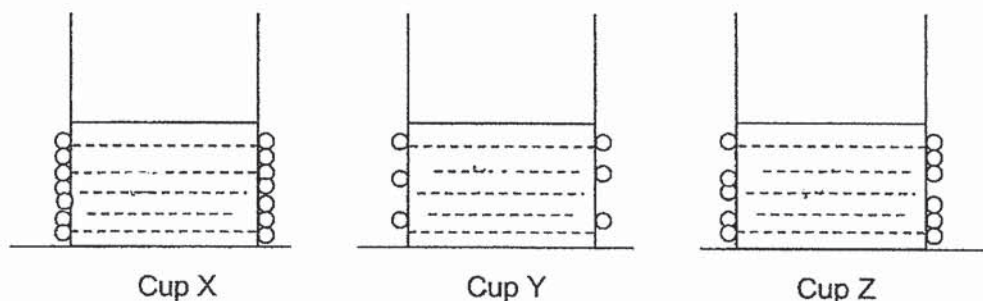

Which of the following shows the most likely temperature of the locations where the cups had been placed in?

Temperature of location ($^{\circ}\text{C}$)			
	Cup X	Cup Y	Cup Z
(1)	0	40	20
(2)	20	40	30
(3)	40	0	20
(4)	40	20	30

13. The table below shows the freezing point and boiling point of substance A.

	Freezing point ($^{\circ}\text{C}$)	Boiling point ($^{\circ}\text{C}$)
Substance A	10	120

Based on the information given above, which of the following statements is correct?

- (1) At 125°C , substance A has a definite shape and volume.
- (2) At 5°C , substance A has no definite shape but a definite volume.
- (3) At 95°C , substance A has no definite shape but a definite volume.
- (4) At 15°C , substance A has no definite shape and no definite volume.

14. Study the diagram below.

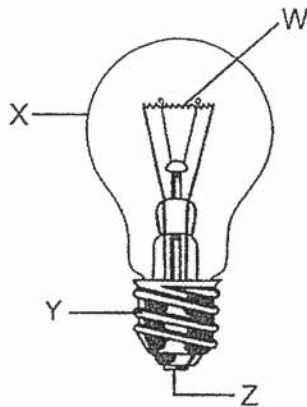

Which parts of the bulb can conduct electricity?

- (1) X and Z only
(2) Y and Z only
(3) W, X and Y only
(4) W, Y and Z only
15. Cadence was given a battery, a bulb and wire. All the electrical components were working properly. She was asked to connect the three electrical components in different ways for the bulb to light up.

She drew the 4 different arrangements, A, B, C and D, as shown below.

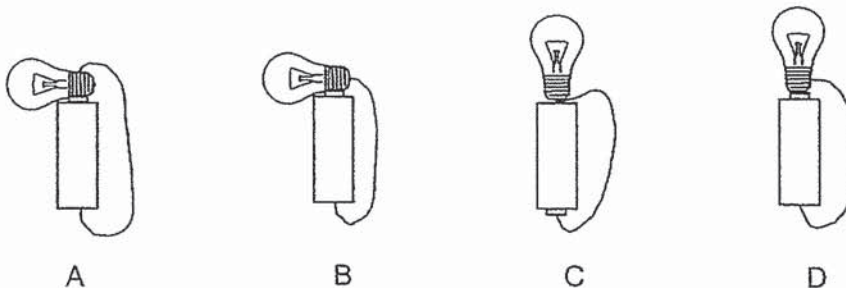

In which arrangements will the bulb light up?

- (1) A and C only
(2) A and D only
(3) B and D only
(4) B, C and D only

16. Nathaniel set up the circuit as shown below and bulb W lit up. Then he connected object X to the circuit.

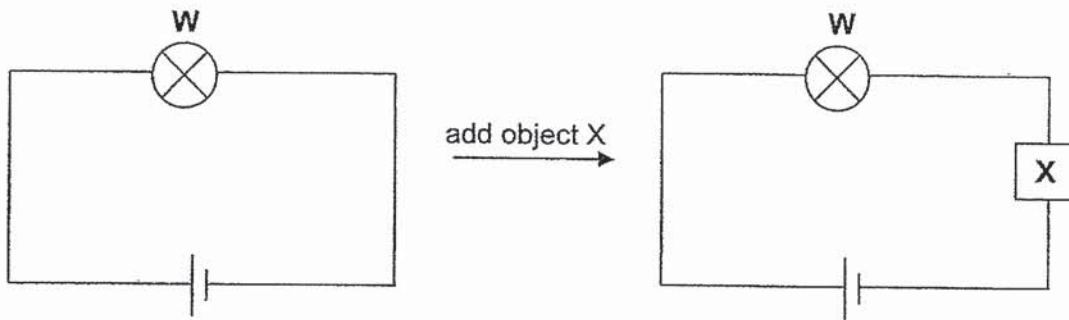

Which of the following could item X be and what is its effect on bulb W?

	Item X	Effect on bulb W
(1)	bulb	became brighter
(2)	plastic rod	did not light up
(3)	copper rod	became brighter
(4)	wooden rod	became dimmer

17. Sonia used new three batteries, three working bulbs and some wires in an electrical circuit as shown below. She placed four objects, aluminium foil, glass marble, iron nail and steel clip, randomly at positions W, X, Y and Z. She found that none of the bulbs lit up.

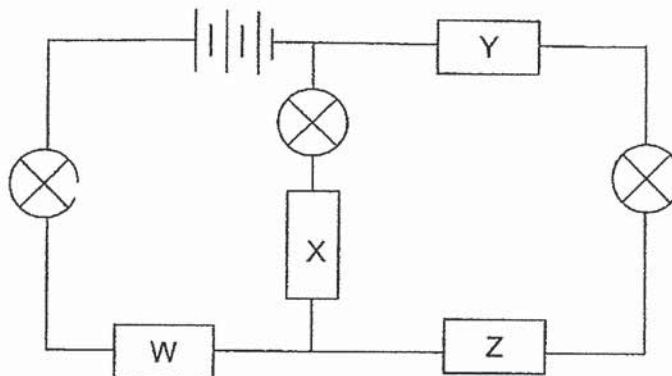

How had Sonia arranged the four objects?

	Aluminium foil	Glass marble	Iron nail	Steel clip
(1)	W	X	Y	Z
(2)	Z	W	X	Y
(3)	Y	Z	W	X
(4)	X	Y	Z	W

18. Study the circuit shown below. All the electrical components were working properly.

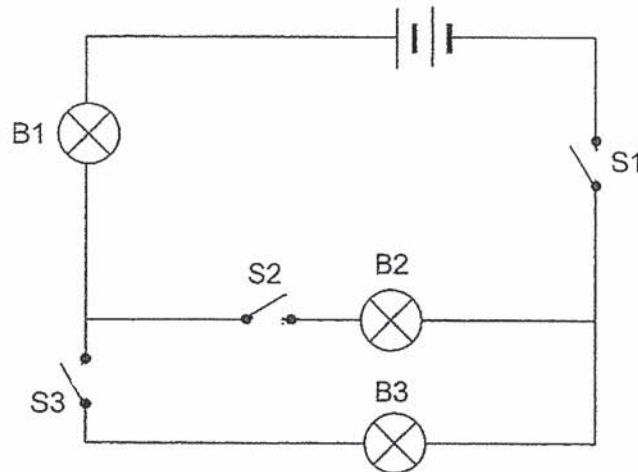

Which of the following shows the correct bulbs lighting up when the switches are opened or closed?

	Switches			Bulbs that lit up
	S1	S2	S3	
(1)	closed	closed	open	B1, B2, B3
(2)	closed	open	closed	Only B1, B3
(3)	open	closed	closed	Only B1
(4)	closed	closed	closed	Only B2, B3

19. Which of the following statement(s) is/are true?

- A It is safe to put many plugs into one socket using an adapter as it saves space.
- B It is dangerous to touch switches with wet hands because water conducts electricity.
- C Electrical appliance with exposed wires is safe to use as the appliance is still working.

- (1) A only
- (2) B only
- (3) A and C only
- (4) B and C only

20. Gao Li set up four electrical circuits as shown below, using identical batteries, bulbs and wires.

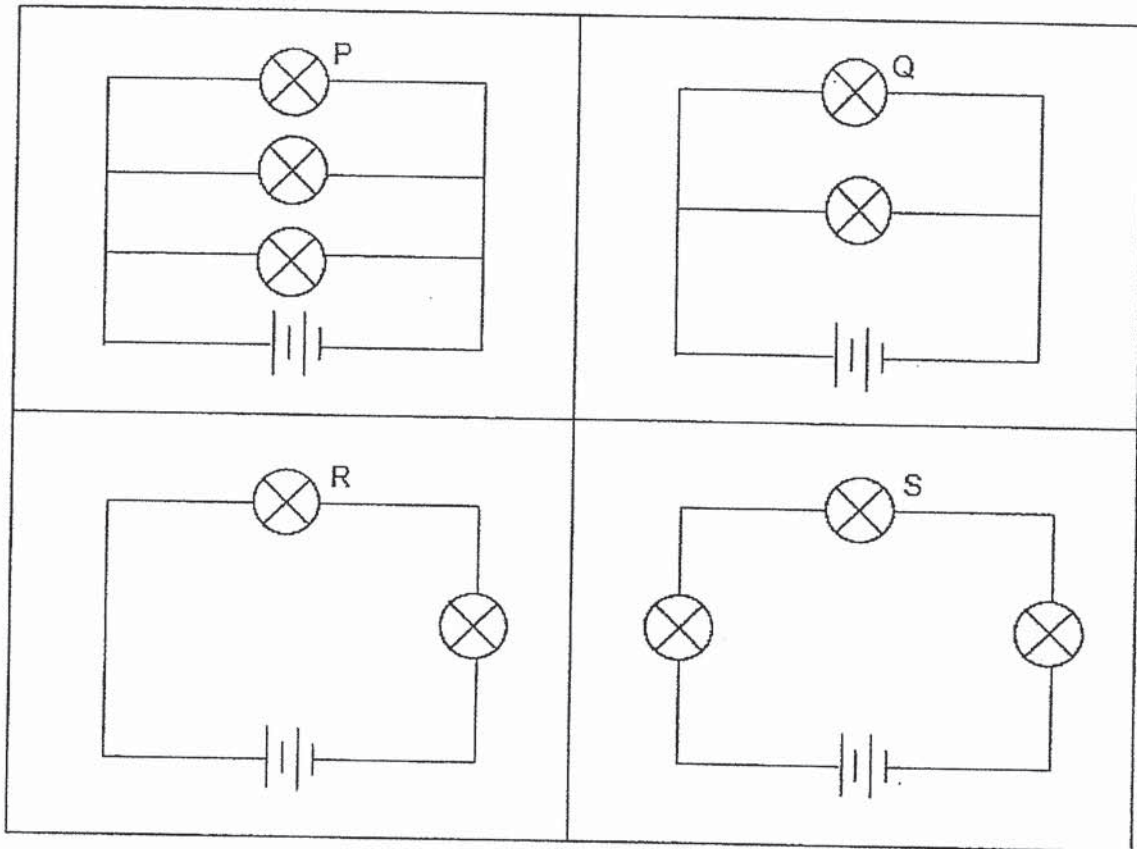

Which of the following correctly shows 3 of the labelled bulbs arranged from the dimmest to the brightest?

	Dimmest	—————>	Brightest
(1)	P	R	S
(2)	Q	S	P
(3)	R	Q	S
(4)	S	R	P

21. Which actions below help to conserve electricity?

- A Use energy-saving light bulbs.
- B Use the fan instead of air-conditioning.
- C Shower without the water heater on a hot day.
- D Leave the television switched on for the whole day.

- (1) A and C only
- (2) A, B and C only
- (3) A, B and D only
- (4) B, C and D only

22. Mahsuri made a circuit card with 6 fasteners, A, B, C, D, E and F. Some of the fasteners were connected under the card by wires. He connected a circuit tester to 2 of the fasteners at a time and recorded his observations in the table below.

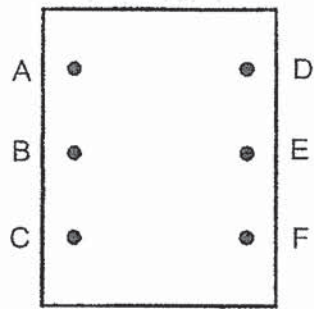

circuit card

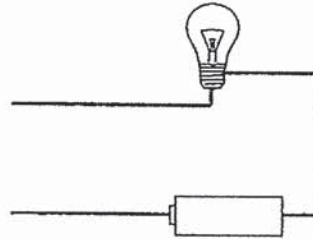

circuit tester

Fasteners tested	Bulb of circuit tester
A and C	Does not light up
B and D	Lights up
B and F	Does not light up
C and E	Lights up
D and E	Lights up
D and F	Does not light up

Based on the observations above, which of the following arrangements below definitely does not represent Mahsuri's card?

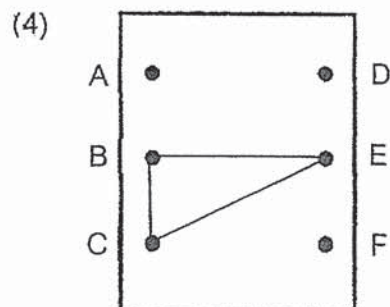
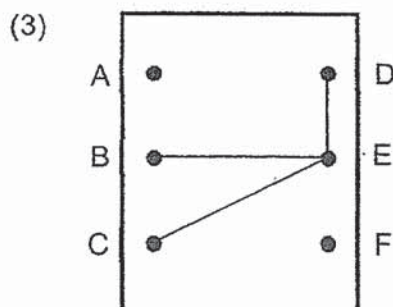
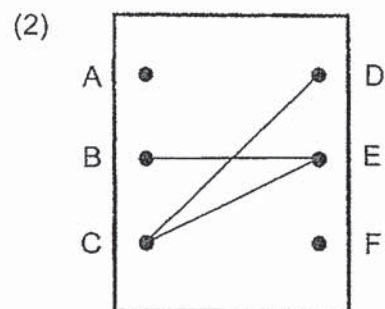
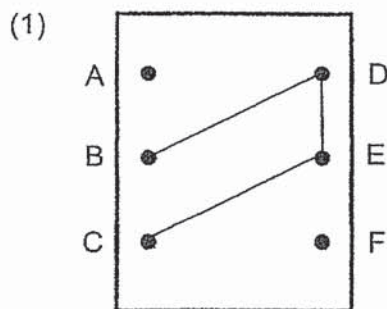

23. Some students made the following statements about forces.

Amanda: A force is a push or a pull.

Bernice: A force can cause a moving object to move faster.

Cathy: A force can only act on objects which are in contact.

Desmond: A force cannot be seen and its effects cannot be observed.

Which students' statements are correct?

- (1) Amanda and Bernice
 (3) Bernice and Desmond

- (2) Amanda and Cathy
 (4) Cathy and Desmond

24. Study the flowchart below carefully.

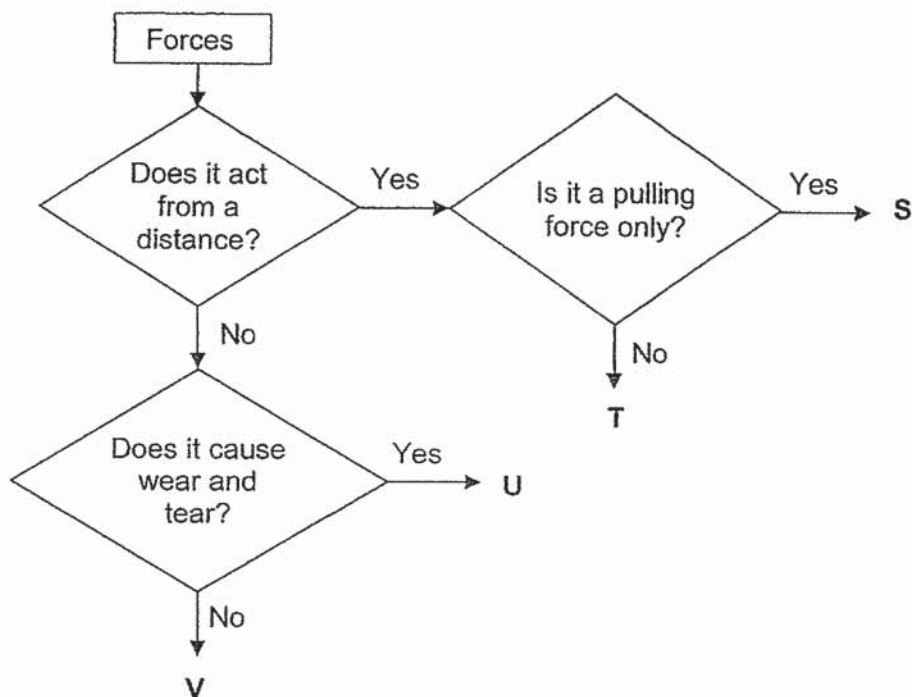

Which of the following correctly represents S, T, U and V?

	S	T	U	V
(1)	magnetic force	elastic spring force	gravitational force	frictional force
(2)	gravitational force	magnetic force	frictional force	elastic spring force
(3)	elastic spring force	frictional force	magnetic force	gravitational force
(4)	gravitational force	magnetic force	elastic spring force	frictional force

25. Ryan conducted an experiment with different surfaces, F, G and H. A wooden block was used to stretch the rubber band 2cm backwards before it was let go.

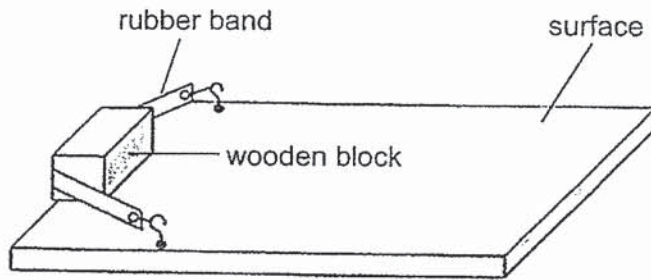

Ryan recorded the distances moved by the wooden block in the table below.

Surface	Distance moved by the wooden block (cm)
F	36
G	12
H	55

Which of the following best represent the materials used to make the surfaces?

	F	G	H
(1)	sandpaper	cardboard	glass
(2)	cardboard	sandpaper	glass
(3)	sandpaper	glass	cardboard
(4)	glass	cardboard	sandpaper

26. Shang Chee set up an experiment as shown in the diagram below.

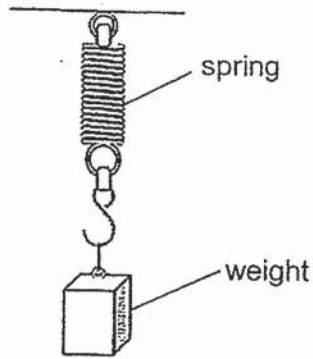

She hung different number of weights on the spring and plotted a graph to measure the effect on the length of spring.

Which of the following graphs correctly showed the changes in the length of the spring when the weights were added?

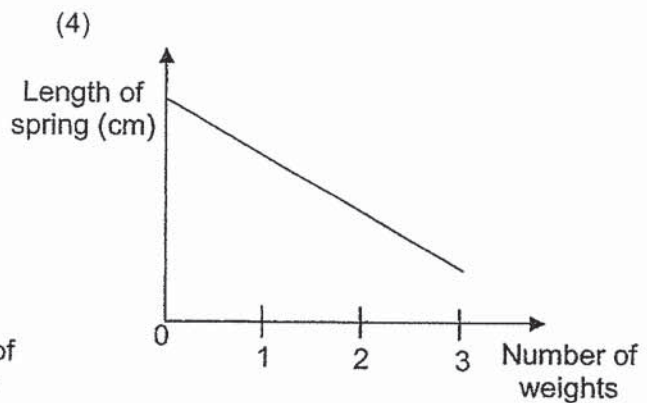
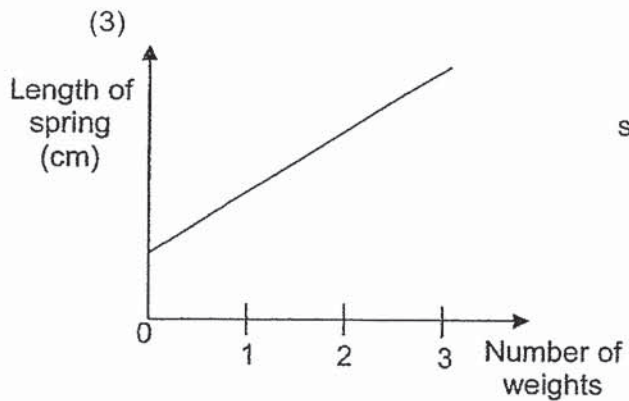
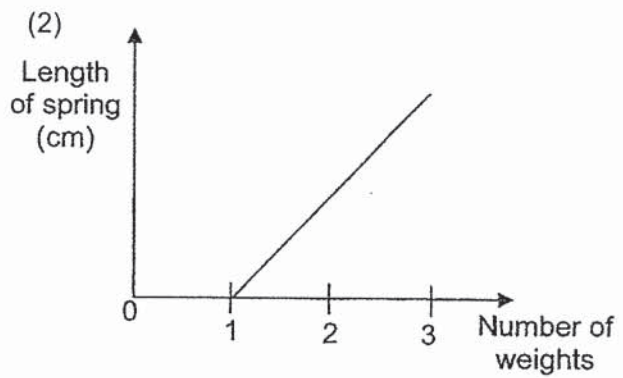
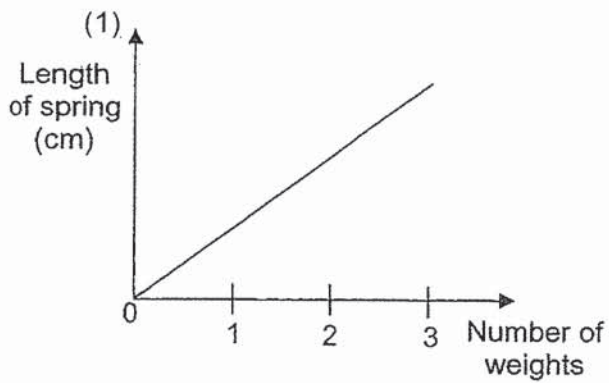

27. Aaron had 3 identical springs, P, Q and R, and two cubes, X and Y, which were of the same size but made of different materials. He placed X and Y on springs Q and R respectively, as shown in the diagram below.

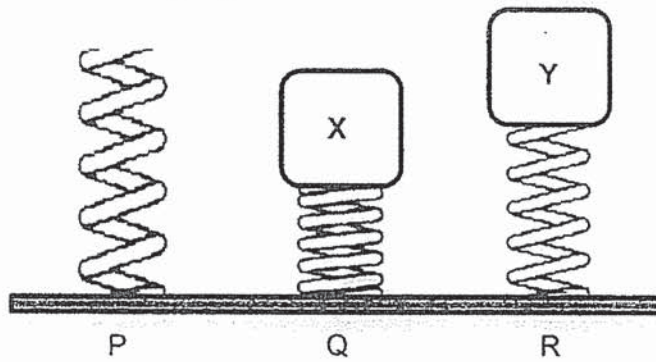

Based on the diagram above, what could Aaron conclude from his experiment?

- A Cube X had a larger mass than cube Y.
- B Spring Q exerted more elastic spring force than spring R.
- C Cube X experienced less gravitational force than cube Y.

- (1) A and B only
- (2) A and C only
- (3) B and C only
- (4) A, B and C

28. Megan hung 4 magnets, D, E, F and G, at the same height above a tray of steel paperclips as shown in the diagram below.

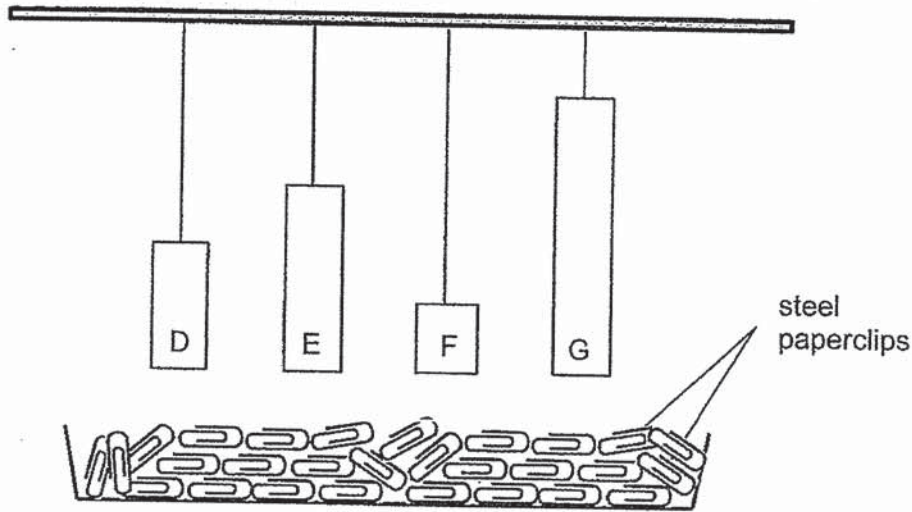

Then, she recorded the number of steel paperclips attracted by each magnet in the table below.

Magnet	D	E	F	G
Number of steel paperclips attracted	7	5	10	9

Based only on the information above, which of the following statements can be concluded?

- A Magnetic force can act from a distance.
- B Magnet G has greater magnetic strength than magnet F.
- C The magnetic strength of the magnet is not dependent on its size.
- D As the size of the magnet increases, its magnetic strength increases.

- (1) A and C only
- (2) B and C only
- (3) A, C and D only
- (4) A, B and D only

~ END OF BOOKLET A ~

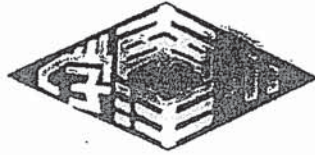

NANYANG PRIMARY SCHOOL
PRIMARY 5 SCIENCE
SEMESTRAL ASSESSMENT 2
2019

BOOKLET B

Date : 22nd Oct 2019

Duration : 1 h 45 min

Name : _____ ()

Class: Primary 5 ()

Marks Scored:

Booklet A:		56
Booklet B :		44
Total :		100

Any query on marks awarded should be raised by 1st November 2019, Friday. We seek your understanding in this matter as any delay in the confirmation of marks will lead to delays in the generation of results.

Parent's signature:

**DO NOT OPEN THIS BOOKLET UNTIL YOU ARE TOLD TO DO SO.
FOLLOW ALL INSTRUCTIONS CAREFULLY.**

Booklet B consists of 16 printed pages including this cover page.

Section B (44 marks)

Write your answers to questions 29 to 40 in the spaces provided.

29. Sabrina gently scraped her inner cheek with a toothpick and prepared a microscope slide to view her cheek cells.

(a) Draw a human ^{animal cell} cheek cell as seen under a microscope, labelling all the main parts. [2]

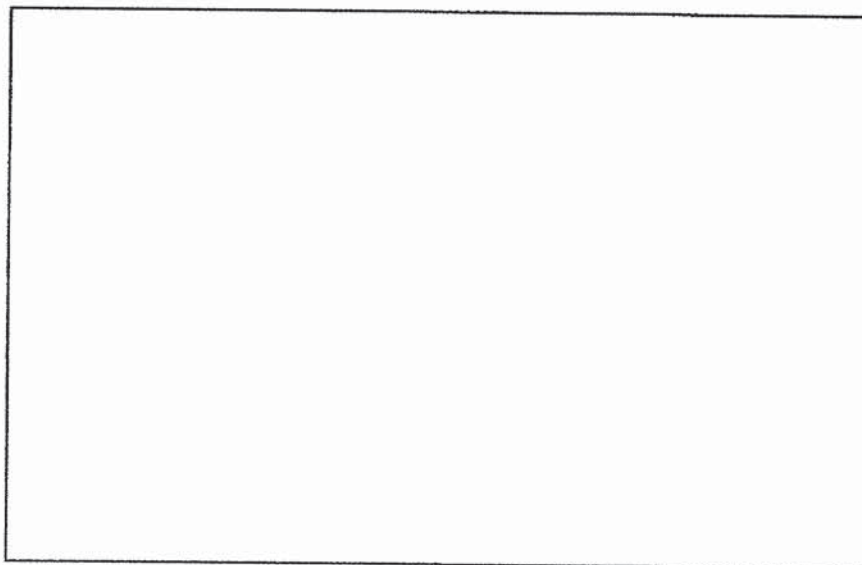

Then Sabrina observed cells X and Y under a microscope as shown below.

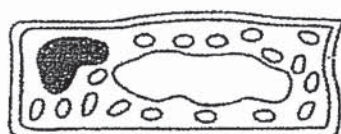

Cell X

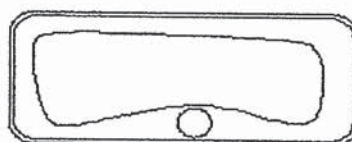

Cell Y

(b) (i) Based on the observations, which cell(s) is/are plant cell(s)? Give a reason for your answer. [1]

(ii) Which part of the plant could cell X have been taken from? [1]

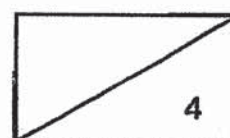

30. A group of 20 students were stuck in a small storeroom without windows for 3 hours.

- (a) In the table below, fill in the blanks with 'increases', 'decreases' or 'remains the same'. [1]

Types of gas	Change in the amount of gas after 3 hours
Oxygen	Decreases
Nitrogen	(i)
Carbon dioxide	(ii)

After being stuck in the room for 3 hours, Xuming's breathing rate increased.

- (b) Based on the table above, explain why Xuming's breathing rate increased. [1]

Xuming noticed that his heart rate increased when he started kicking and shouting for help

- (c) Explain why his heart rate increased when he was kicking and shouting. [2]

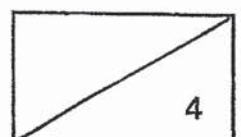

31. Lucas saw 2 different types of trees, X and Y, growing in the same park. He measured the distance between 30 fruits of tree X and its parent tree, in the table below. He then repeated it for fruits of tree Y.

Distance between the fruit and parent tree (m)	Number of fruits of tree X	Number of fruits of tree Y
0 to 10	3	28
10 to 20	9	2
20 to 30	11	0
30 to 40	7	0

Study the 2 fruits, A and B, below carefully.

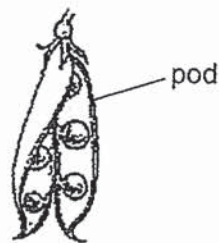

fruit A

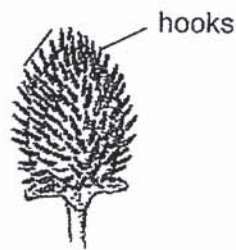

fruit B

- (a) Which fruit, A or B, is likely to be the fruit of tree X? Explain your answer. [2]

- (b) The seedlings of tree Y are observed to be growing less healthily than the seedlings of tree X. Explain why this is so. [2]

(Continued Question 31)

Lucas continued walking around the park and picked up fruit C, as shown in the diagram below.

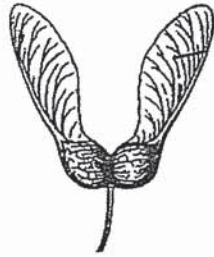

fruit C

Lucas' teacher said that fruit C has a structure which enables it to be dispersed effectively.

- (c) State what structure fruit C has and explain how it helps fruit C to be dispersed.

[1]

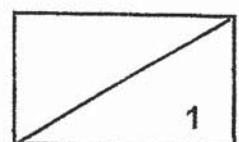

32. The diagrams below show the life cycles of a grasshopper and a butterfly.

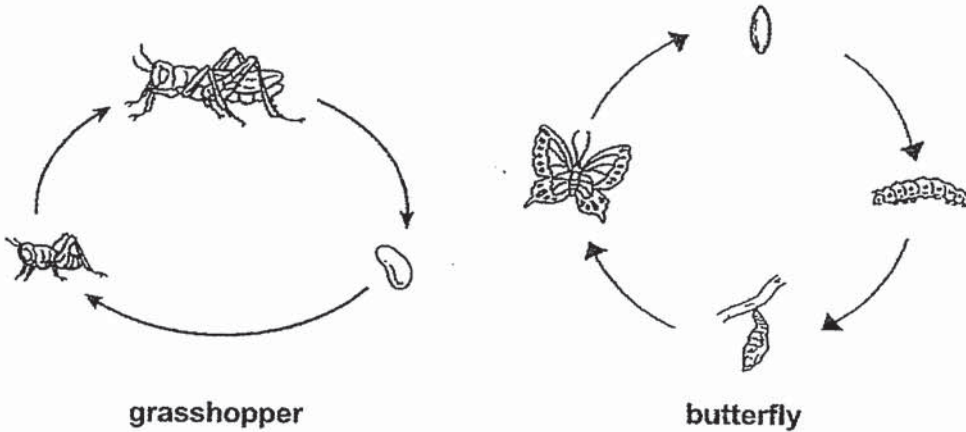

(a) Based on the life cycles above, state two differences between the life cycles of the grasshopper and the butterfly. [2]

(i) _____

(ii) _____

(b) Name the **stage** of the life cycle in which the butterfly is considered a pest by the farmers. Explain your answer. [1]

(c) State one way the grasshoppers and butterflies ensure that at least some of their eggs will be hatched and the young can grow into adults. [1]

33. (a) In the box below, draw the life cycle of the sunflower plant and name the stages. [1]

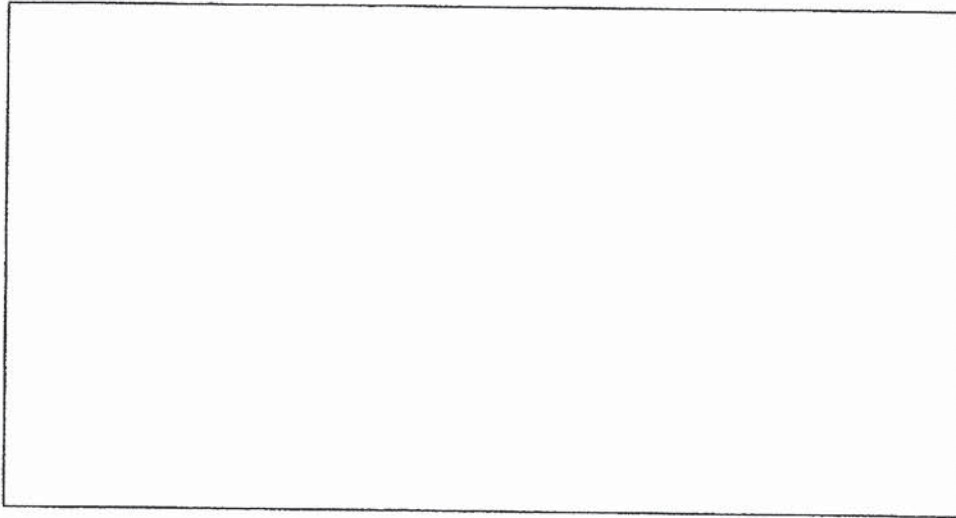

- (b) State all the conditions needed for the germination of seeds. [1]

The diagram below shows a green bean seedling.

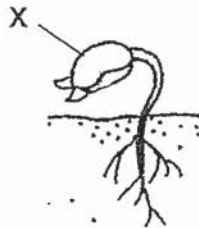

- (c) What will happen to the seedling if part X is totally removed? Explain your answer. [1]

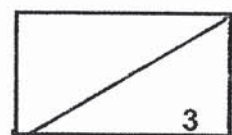

34. The diagrams below represent 2 human organ systems.

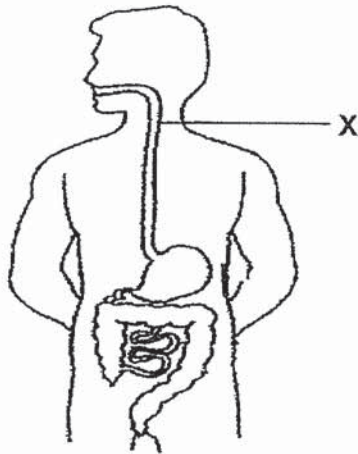

Organ system A

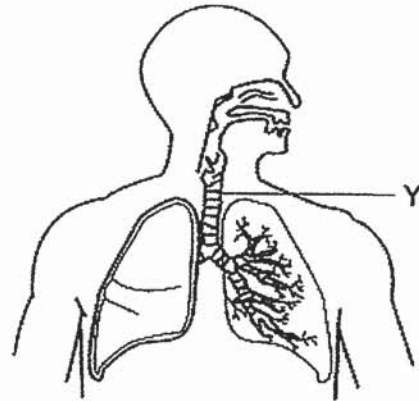

Organ system B

(a) State the difference in function between parts X and Y. [1]

(b) State all the functions of organ system B. [1]

35. The graph below shows the amount of undigested food found leaving the different parts of the human digestive system.

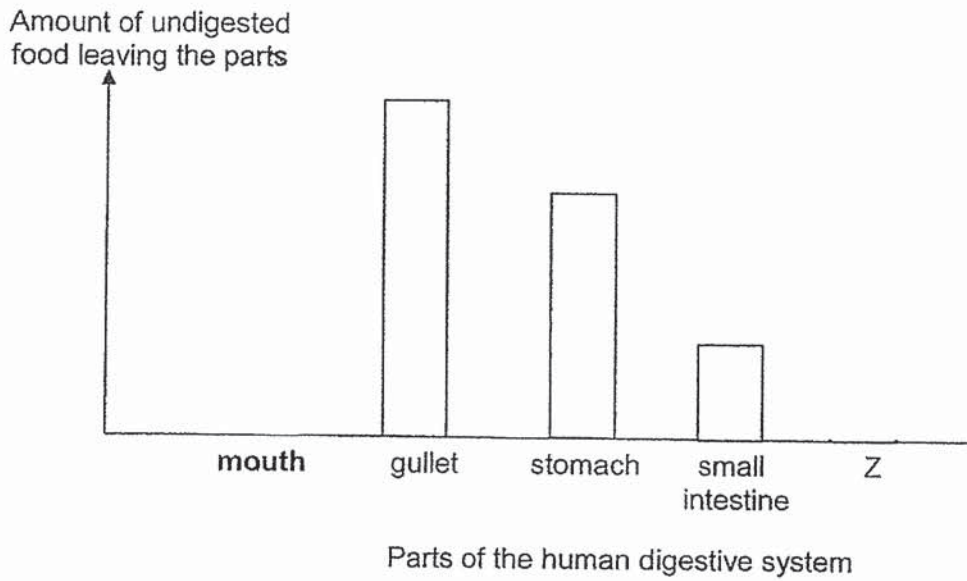

- (a) **Draw** the amount of undigested food leaving the mouth in the bar graph above. [1]

- (b) State the 2 functions of the small intestine. [2]

(i) _____

(ii) _____

- (c) Based on the graph above, explain why organ Z is most likely the large intestine. [1]

36. Tom poured 10ml of water into each of the 3 similar cups, A, B and C. He placed the cups in different rooms with different temperatures and recorded the amount of water in each cup after 4 hours, as shown in the table below.

Cup	Temperature of room (°C)	Amount of water left (ml)
A	30	4
B	10	9
C	20	6

- (a) State the relationship between the temperature of room and the rate of evaporation of water. [1]

- (b) Explain clearly why cup B has the most amount of water left after 4 hour. [1]

After Tom washed his hands, he blew on them.

- (c) Explain why Tom's hands felt cold after that. [2]

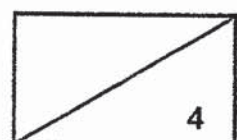

37. Chee Hian set up two electrical circuits using 2 batteries, some wires and 4 bulbs as shown in the diagram below. All four bulbs lit up.

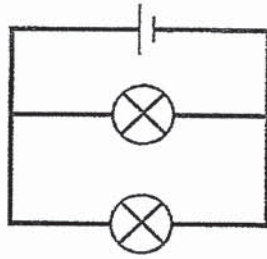

Set-up 1

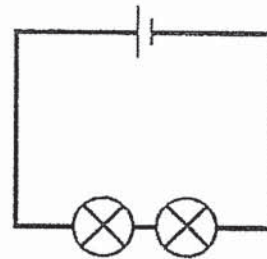

Set-up 2

Then he removed one bulb from each set-up, leaving a gap in the circuit.

What would Chee Hian observe about the remaining bulb in each set-up? Explain your answer. [2]

Set-up 1 :

Set-up 2 :

38. The diagram below shows the electrical circuit of a doorbell.

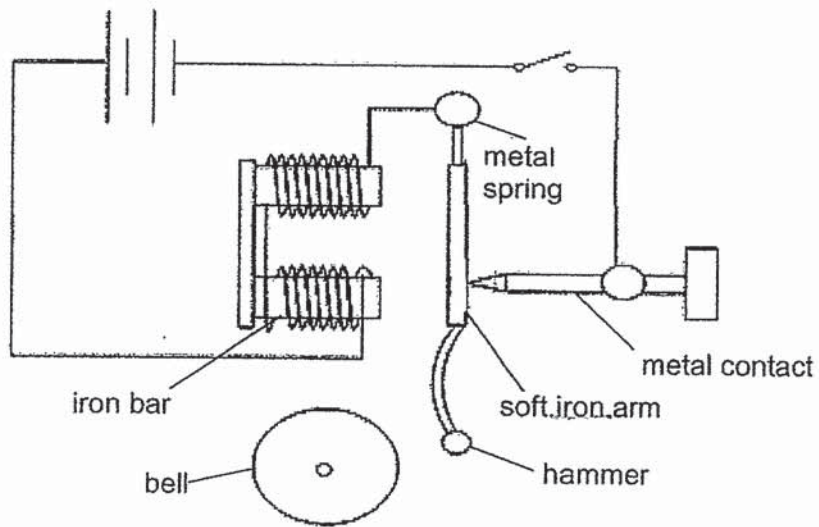

- (a) Based on the diagram above, describe how the hammer is able to hit the bell when the switch is closed. [2]

- (b) Explain why the hammer hits the bell repeatedly when the switch is kept closed. [1]

39. In a game show, three players competed to answer the most questions correctly. When the question was asked, the players had to press the switch on the table which would light up the indicator in front of them. The player whose indicator lit up first would get the chance to answer the question.

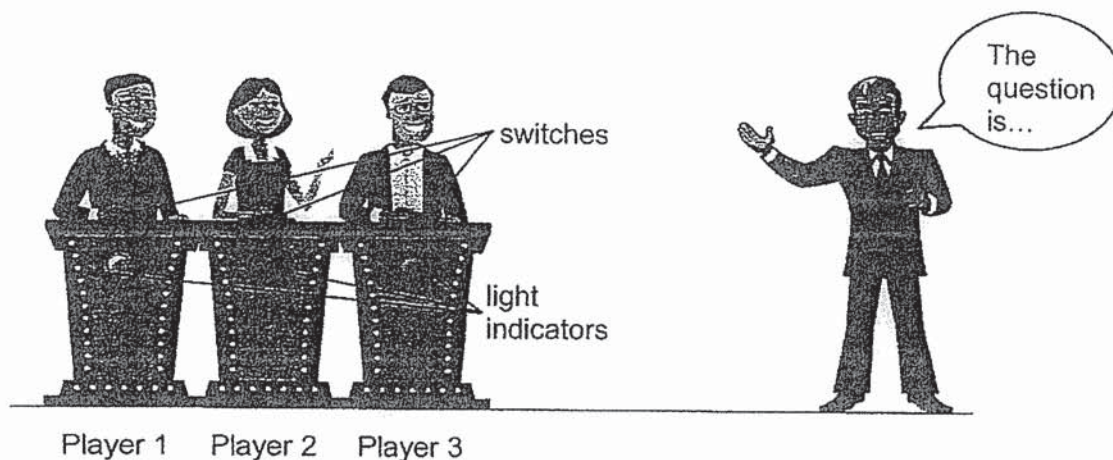

- (a) Complete the electrical circuit below by drawing 3 switches and 3 light indicators with wires, to work as needed for the game show. [2]

Component	Symbol
switch	
light indicator	

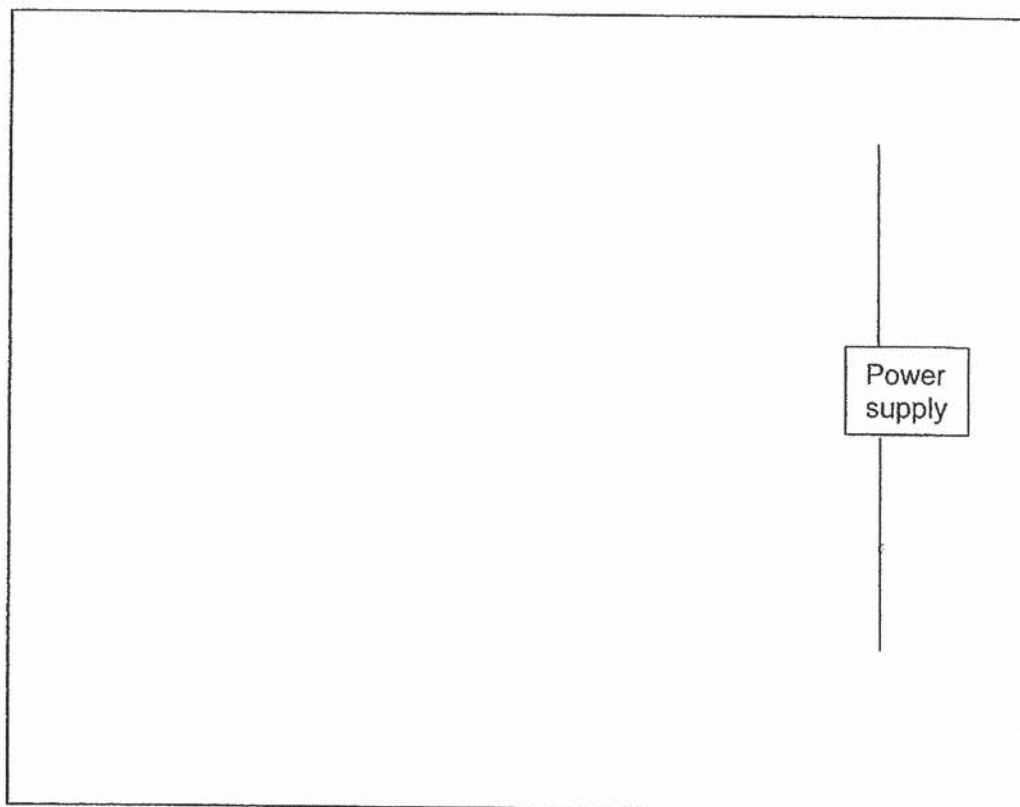

(Continued Question 39)

An electrical circuit with working batteries and bulbs, P, Q, R and S, is shown below. All the bulbs are lit.

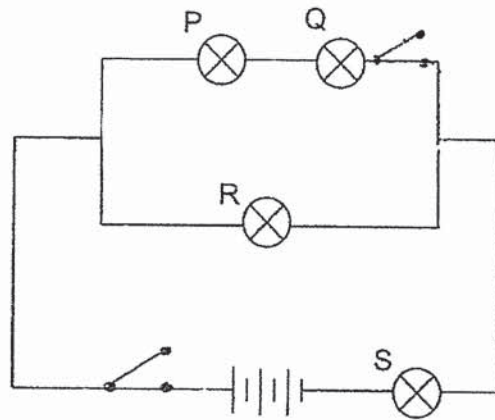

A switch was added to the circuit.

(b) **Mark with an 'X'** on the circuit above where the switch should be placed so that if it is opened, only two bulbs will light up. [1]

(c) If 2 batteries were removed, what would be observed about the bulbs? [1]

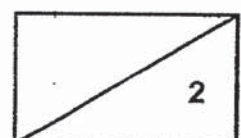

40. Sean placed a full-length mirror on the floor and against the wall, as shown in the diagram below.

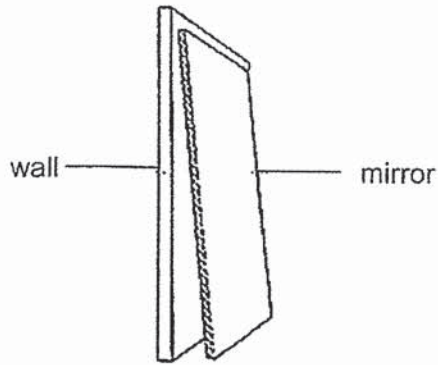

The mirror is prevented from sliding away from the wall by frictional force.

- (a)(i) In the diagram below, draw an arrow to show the frictional force acting between the wall and the mirror [1]

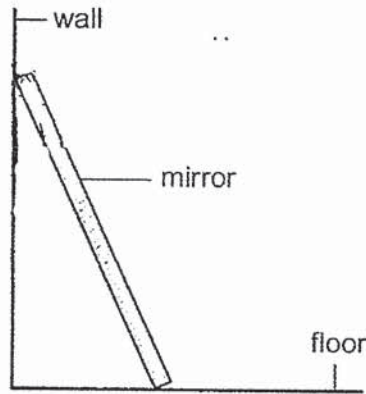

- (a)(ii) In the diagram below, draw an arrow to show the frictional force acting between the mirror and the floor [1]

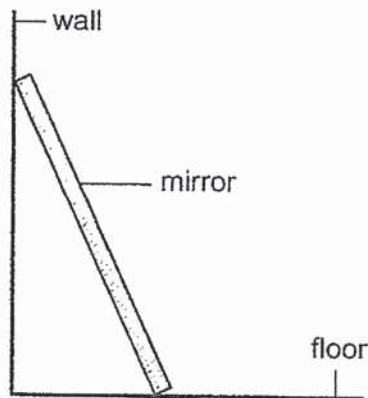

(Continued Question 40)

Sean conducted an experiment using the set-up as shown below.

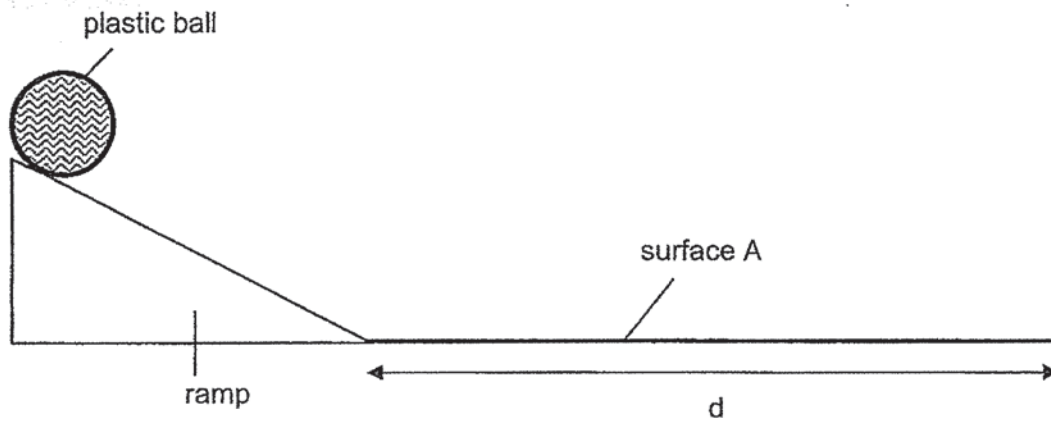

He released a plastic ball at the top of the ramp and recorded the distance travelled by the ball, d , after it came to a stop. He conducted the experiment using different surfaces, A, B and C.

He recorded the results in the table below.

Surface	A	B	C
Distance d (cm)	98	35	73

- (b) Based on the results of the experiment, which surface A, B or C, is most suitable for making the floor of a bathroom? Explain your answer. [2]

- (c) Give one example to explain how friction is useful to us in our daily lives. [1]

~ END OF BOOKLET B ~

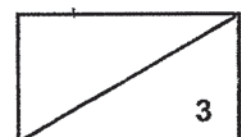

Nanyang Primary School
P5 SCIENCE SA2 2019 Suggested Answer

Section A											
1.	2	6.	2	11.	1	16.	2	21.	2	26.	3
2.	3	7.	3	12.	4	17.	2	22.	4	27.	1
3.	1	8.	4	13.	3	18.	2	23.	1	28.	1
4.	3	9.	3	14.	4	19.	2	24.	2		
5.	1	10.	4	15.	3	20.	4	25.	2		

Section B

29a.

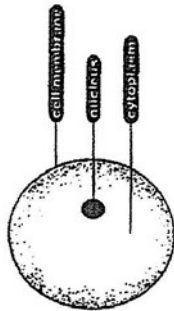

29bi. Cells X and Y.

They both have cell walls.

29bii. Cell X is taken from the leaf.

30ai. Remains the same

30aii. Increases

30b. There was li

same amount

30c. His heart n

to all

body.

faster to take in the

to remove more carbon dioxide/waste materials from the

31a. Fruit B. There are hooks on the fruit to stick to the fur of animals, so the fruits are more randomly dispersed/ dispersed further from parent plant.

31b. The seedlings of tree Y are grown closer to the parent plant hence they have to compete for sunlight, space, water and minerals.

31c. Fruit C has wing-like structure which enables it to be dispersed by wind.

32ai. The grasshopper has 3 stages in its life cycle but the butterfly has 4 stages in its life cycle.

32aii. The young of the grasshopper resembles the adult but the young of the butterfly does not resemble the adult.

32b. Larva stage. The caterpillars will eat up the leaves of the farmers' crops.

32c. They lay many eggs at one go.

33a.

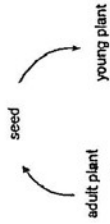

33b. Water, air, suitable temperature/ warmth

33c. The seedling will die because it has no food.

34a. Part X transports small food pieces from the mouth to the stomach but Part Y transports air from the nose to the lungs.

34b. The respiratory system transports air (oxygen) to all parts of the body and removes air (carbon dioxide) from the body.

35a.

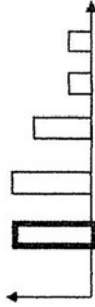

35bi. Digestion of food (is completed).

35bii. Digested food is absorbed into the bloodstream.

35c. As there is no digestion taking place in the large intestine, the amount of undigested food will remain the same between organ Z and small intestine.

36a. As the temperature of the room increases, the rate of evaporation increases.

36b. Cup B was placed in the room with the lowest temperature hence the rate of evaporation is the lowest.

36c. When Tom blew on his hand, there is wind and the water on his finger evaporates. Water gained heat from his hand when it evaporated/ his hand lost heat to the water which has evaporated.

37. In set-up 1, the bulbs are in a parallel arrangement so when there is a gap in the circuit, electric current still flows and the remaining bulb will light up.

In set-up 2, the bulbs are in a series arrangement. When there is a gap in the circuit, electric current does not flow and the other bulb will not light up.

38a. When the switch is closed, electric current flows through the circuit. The iron bar becomes an electromagnet and attracts the soft iron arm, so the hammer will swing over and hit the bell.

38b. When the soft iron arm moves away from the metal contact, there is a gap in the circuit and the electromagnet no longer attracts the soft iron arm, so the soft iron arm returns to its original position. The circuit closes again so the electromagnet would attract the soft iron arm and hits the bell again.

39a.

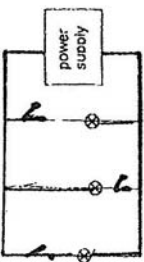

39b.

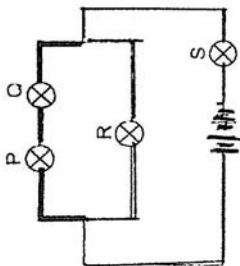

'X' can be marked anywhere along the bold lines.

39c. Bulbs will be dimmer.

40ai.

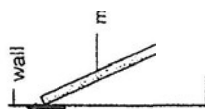

40c.



40b. Surface B. The distance travelled by the ball is the least hence there is most friction between the ball/ feet and surface. Surface B is most suitable to be used to make the floor of the bathroom so that the users will not slip and fall easily.

40c. Friction between the sole of the shoes/ feet and floor allows us to walk on the floor.