



**Rosyth School  
Preliminary Examination 2009  
Primary 6 Mathematics**

Name: \_\_\_\_\_ Register No. \_\_\_\_\_

Class: Pr 6 \_\_\_\_\_

Date: 26 Aug 2009

Parent's Signature: \_\_\_\_\_

Total Time for Booklets A and B : 50 min

---

**PAPER 1  
(Booklet A)**

Instructions to Pupils:

1. Do not open this booklet until you are told to do so.
2. Follow all instructions carefully.
3. Shade your answers in the Optical Answer Sheet (OAS) provided.
4. You are not allowed to use a calculator
5. Answer all questions.

Section	Maximum Mark	Marks Obtained
Paper 1 (Booklet A)	20	

\* This booklet consists of 8 pages (including this cover page)

This paper is not to be reproduced in part or whole without the permission of the Principal.

Questions 1 to 10 carry 1 mark each. Questions 11 to 15 carry 2 marks each. For each question, four options are given. One of them is the correct answer. Make your choice (1, 2, 3 or 4). Shade the oval (1, 2, 3 or 4) on the Optical Answer Sheet. (20 marks)

---

1 Which of the following numbers is the largest?

(1) 0.7

(2) 0.62

(3) 0.097

(4) 0.506

2 3 boys share 4 pizzas equally. Each boy gets ? pizza.

(1)  $\frac{3}{4}$

(2)  $1\frac{1}{3}$

(3)  $1\frac{2}{3}$

(4)  $1\frac{1}{4}$

3 Find the value of  $\frac{3}{5} \div 15$ .

(1)  $\frac{1}{5}$

(2)  $\frac{1}{25}$

(3) 9

(4) 15

- 4 Elaine started her exercise at 7.45 a.m. and ended 1 hour and 30 minutes later. At what time did she finish her exercise?

- (1) 8.15 a.m.
- (2) 8.45 a.m.
- (3) 9.15 a.m.
- (4) 9.30 a.m.

- 5 What is the value of  $45 - (12 + 6) \div 3 \times 2$  ?

- (1) 18
- (2) 26
- (3) 33
- (4) 42

- 6 The table below shows the rates of printing photographs at a shop.

Number of photographs	Cost
First 10 photographs	\$0.35 per photo
11 <sup>th</sup> photograph onwards	\$0.30 per photo

How much would Alphonsus have to pay for printing 15 photos?

- (1) \$1.50
- (2) \$3.50
- (3) \$4.50
- (4) \$5.00

7 Find the value of  $\frac{40-3a}{5}$  when  $a = 5$ .

- (1) 1
- (2) 5
- (3) 7
- (4) 25

8 Ming Xuan poured some water into a rectangular container measuring 10 cm by 3 cm by 6 cm as shown below.

The water reached a height of 4 cm.

What was the volume of the water in the container?

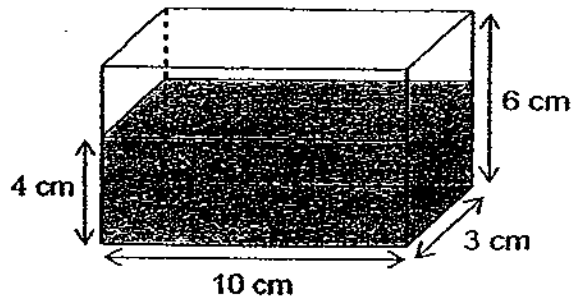

- (1)  $30 \text{ cm}^3$
- (2)  $40 \text{ cm}^3$
- (3)  $120 \text{ cm}^3$
- (4)  $180 \text{ cm}^3$

9 There is one pair of parallel lines in the figure. They are \_\_\_\_\_ ?

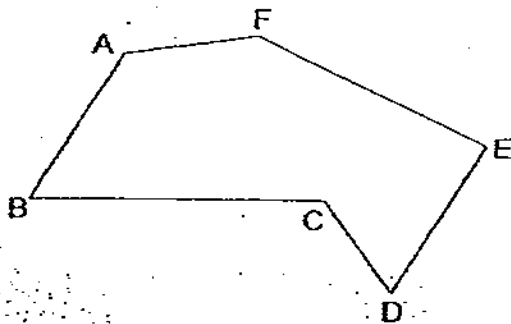

- (1) AB and ED
- (2) AB and CD
- (3) AF and BC
- (4) EF and DC

10 Mr Phua wants to tile his bathroom floor with tiles of only one shape and they must fit together with no gaps in between.

Which of these shapes can he choose from?

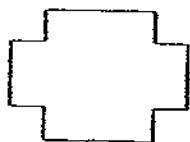

A

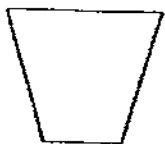

B

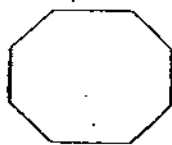

C

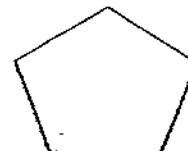

D

- (1) A
- (2) B
- (3) C
- (4) D



- 11 Amirah added the first 53 even numbers.

$$2 + 4 + 6 + 8 + 10 + \dots + 102 + 104 + 106 = ?$$

In the sum above, what is the digit in the ones place?

- (1) 0
- (2) 2
- (3) 6
- (4) 4

- 12 There are 10 boys and 40 girls in a speech class.  
What is the percentage of boys in the speech class?

- (1) 10%
- (2) 20%
- (3) 25%
- (4) 80%

- 13 Find the area of the triangle shown below.

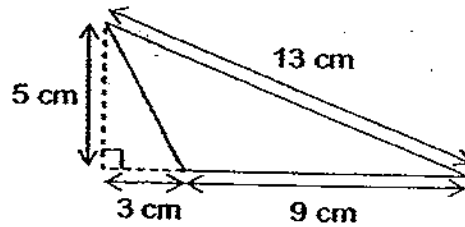

- (1) 7.5 cm<sup>2</sup>
  - (2) 22.5 cm<sup>2</sup>
  - (3) 30 cm<sup>2</sup>
  - (4) 58.5 cm<sup>2</sup>
- 14 A rectangular piece of paper, coloured on one side, is folded to form the shape shown below.

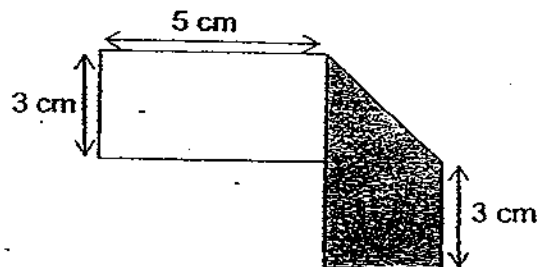

What is the area of the rectangular piece of paper before it was folded?

- (1) 15 cm<sup>2</sup>
- (2) 24 cm<sup>2</sup>
- (3) 28.5 cm<sup>2</sup>
- (4) 33 cm<sup>2</sup>

15 What will the solid look like if viewed from the top?

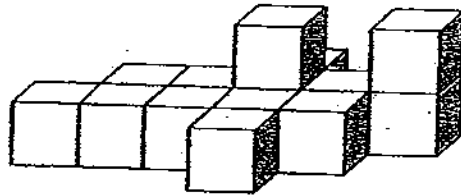

(1)

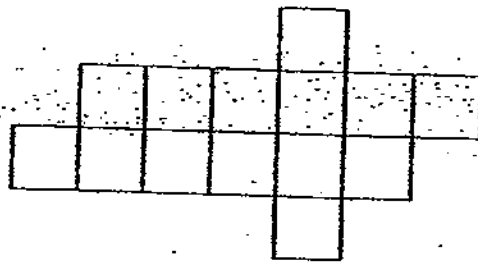

(2)

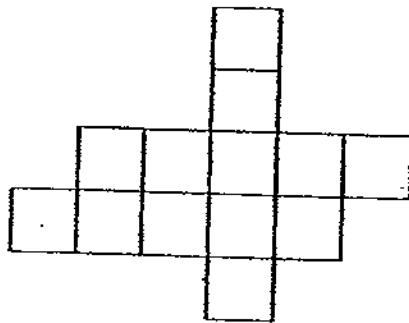

(3)

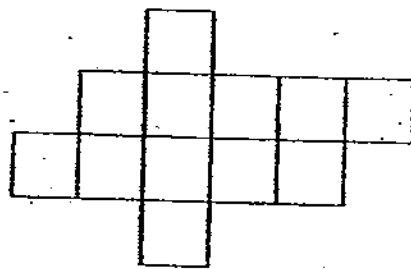

(4)

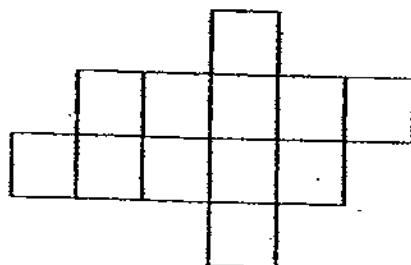





**Rosyth School  
Preliminary Examination 2009  
Primary 6 Mathematics**

Name: \_\_\_\_\_ Register No. \_\_\_\_\_

Class: Pr 6 - \_\_\_\_\_

Date: 26 Aug 2009

Parent's Signature: \_\_\_\_\_

Total Time for Booklets A and B : 50 min

---

**PAPER 1  
(Booklet B)**

Instructions to Pupils:

1. Do not open this booklet until you are told to do so.
2. Follow all instructions carefully.
3. Shade your answers in the Optical Answer Sheet (OAS) provided.
4. You are not allowed to use a calculator
5. Answer all questions.

Section	Maximum Mark	Marks Obtained
Paper 1 (Booklet B)	20	

\* This booklet consists of 7 pages (including this cover page)

This paper is not to be reproduced in part or whole without the permission of the Principal.

Questions 16 to 25 carry 1 mark each. Write your answers in the spaces provided. For questions which require units, give your answers in the units stated. (10 marks)

Do not write in this space

16

4	6	8
---	---	---

Using any 2 numbers in the box above, form the largest two-digit number which is a multiple of 4.

Ans: \_\_\_\_\_

17 Express  $3\frac{8}{100}$  as a decimal.

Ans: \_\_\_\_\_

18 For every chocolate cake that Mary makes, she uses  $\frac{2}{5}$  cup of chocolate powder. How many cups of chocolate powder will she use to make 15 chocolate cakes?

Ans: \_\_\_\_\_

- 19 The diameter of a circle is 14 cm. Find its area. (Take  $\pi = \frac{22}{7}$ )

Do not write  
in this space

Ans: \_\_\_\_\_  $\text{cm}^2$

- 20 The average of 4 numbers is 12. One of the numbers is 15.  
Find the average of the other 3 numbers.

Ans: \_\_\_\_\_

- 21 Satish's present age is 5 years 7 months.  
What will be his age in 11 months' time?

Ans: \_\_\_\_\_ years \_\_\_\_\_ months

- 22 Refer to the word below.  
Write down the letters that contain parallel lines.

**SINGAPORE**

Ans: \_\_\_\_\_ and \_\_\_\_\_

Do not write  
in this space

- 23 How many angles inside the figure are greater than a right angle?

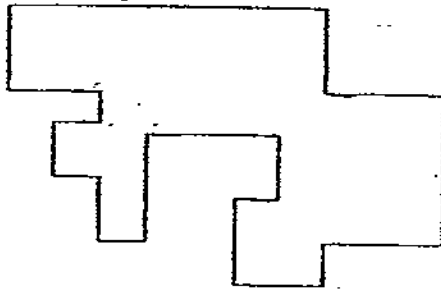

Ans: \_\_\_\_\_

- 24 Andy, Rui Ying and Victor shared \$110 in the ratio 5 : 3 : 2.  
How much money did Rui Ying receive?

Ans: \$ \_\_\_\_\_

25 Express  $\frac{1}{6}$  minute in seconds.

Do not write  
in this space

Ans: \_\_\_\_\_ s

26 In the figure (not drawn to scale), ABC and DBE are straight lines.  
Find  $\angle y$ .

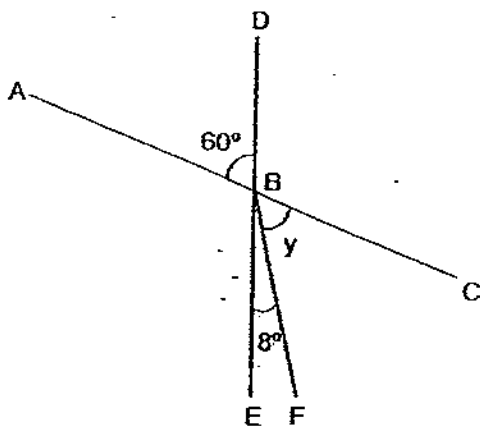

Ans: \_\_\_\_\_ °

27 In the figure below,  $AB = BC$ .

The value of A is  $\frac{4}{9}$ . The value of C is  $\frac{5}{9}$ .

Find the value of B. (Give your answer in its simplest form.)

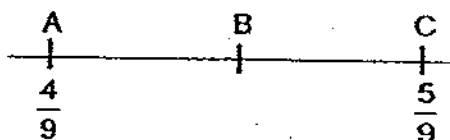

Ans: \_\_\_\_\_

28 The L-shaped figure below contains 7 identical squares.

The area of the figure is  $28 \text{ cm}^2$ . What is its perimeter?

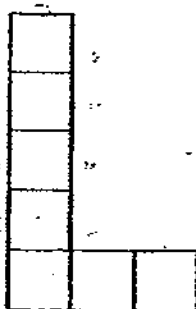

Ans: \_\_\_\_\_ cm

Do not write  
in this space

- 29 Siti bought 4 identical files and 1 book.  
The total cost for all the items is \$20.  
If the book costs \$3a, how much did she pay for each file?

Do not write  
in this space

Ans: \$ \_\_\_\_\_

- 30 The graph below shows the number of visitors at a shopping mall.

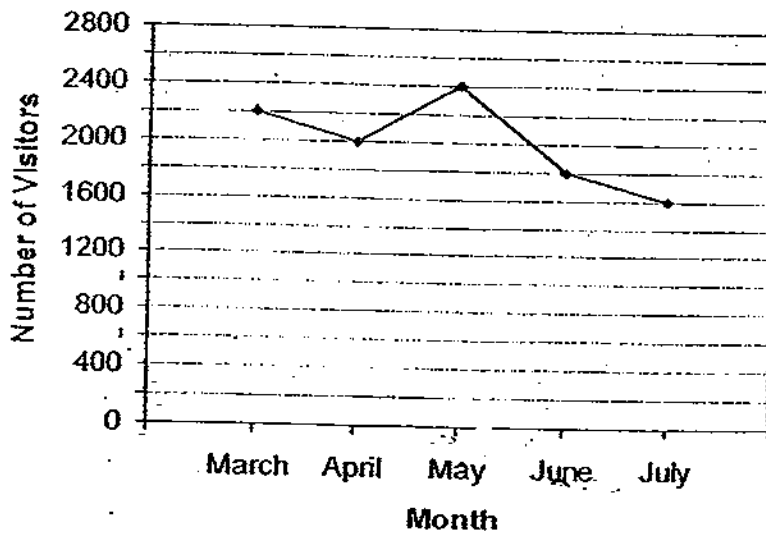

What was the decrease in the number of visitors from May to June?

Ans: \_\_\_\_\_

END OF PAPER



**Rosyth School**  
**Preliminary Examination 2009**  
**Primary 6 Mathematics**

Name: \_\_\_\_\_ Register No. \_\_\_\_\_

Class: Pr 6 - \_\_\_\_\_

Date: 26 Aug 2009

Parent's Signature: \_\_\_\_\_

Time: 1 h 40 min

**PAPER 2**

Instructions to Pupils:

1. Do not open this booklet until you are told to do so.
2. Follow all instructions carefully.
3. Show your workings clearly as marks are awarded for correct working.
4. Write your answers in this booklet.
5. You are allowed to use a calculator
6. Answer all questions.

Questions	Maximum Mark	Marks Obtained
Q 1 to 5	10	
Q 6 to 18	50	

Section	Maximum Mark	Marks Obtained
Paper 1	40	
Paper 2	60	
Total	100	

\* This booklet consists of 16 pages (including this cover page)  
 This paper is not to be reproduced in part or whole without the permission of the Principal.



Questions 1 to 5 carry 2 marks each. Show your working clearly in the space provided for each question and write your answers in the spaces provided. For questions which require units, give your answers in the units stated.

(10 marks)

Do not write in this space

- 1 Three identical cubes weigh 5.4 kg. 4 identical metal balls weigh 4.8 kg. How much do 4 cubes and 2 metal balls weigh?

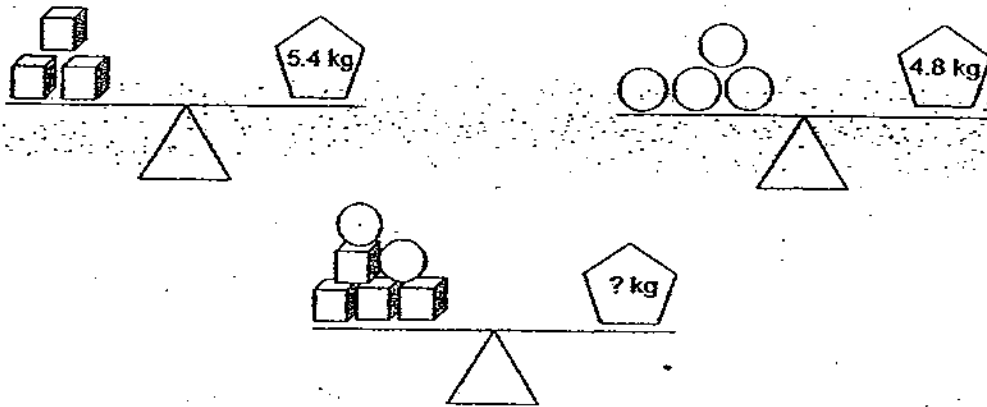

Ans: \_\_\_\_\_ kg [2m]

- 2 30% of a number is 48. What is 85% of the number?

Ans: \_\_\_\_\_ [2m]

The bar graph below shows the donations made in a charity drive.  
Read the bar graph carefully and answer questions 3 and 4.

Do not write  
in this space

**Donations made in a Charity Drive**

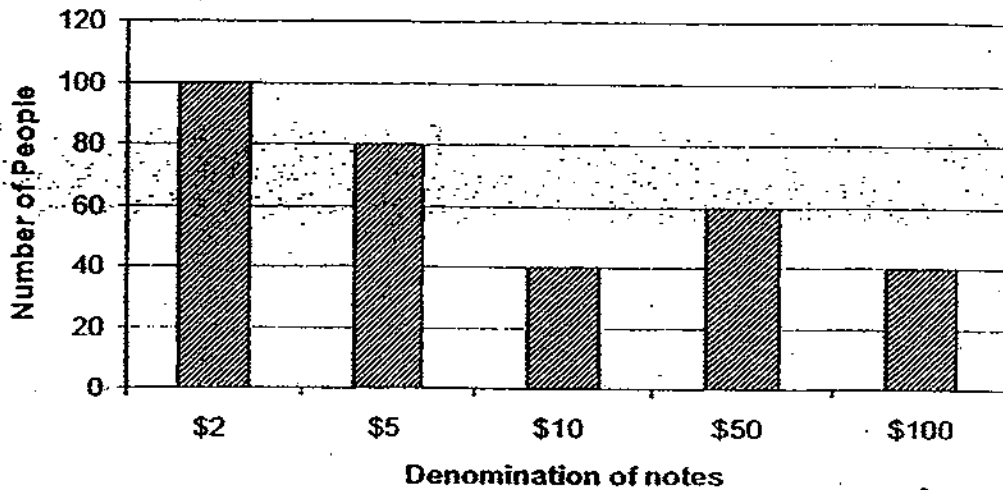

3 How many people donated money in the charity drive?

Ans: \_\_\_\_\_ [2m]

4 What is the average sum of money each person donated?

Ans: \_\_\_\_\_ [2m]

5 Find the area of the square in the figure below.

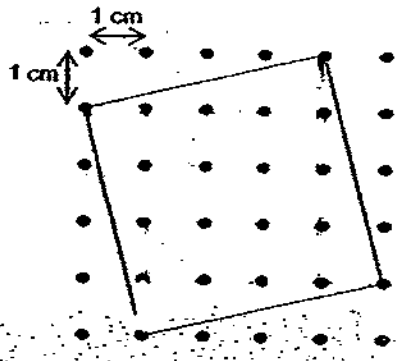

Do not write  
in this space

Ans: \_\_\_\_\_  $\text{cm}^2$  [2m]

Questions 6 to 18, show your working clearly in the space provided for each question and write your answers in the spaces provided. The number of marks available is shown in brackets [ ] at the end of each question or part-question.

(50 marks)

Do not write in this space

- 6 Jack took 4 tests. The average of these tests is 80 marks.  
 The maximum marks for each test is 100.  
 The difference between the Mathematics mark and Science mark is 23.  
 How many marks did he get for Mother Tongue?

Subject	Marks
English	85
Mathematics	95
Science	?
Mother Tongue	?

Ans: \_\_\_\_\_ [3]

- 7 The diagram below shows a triangle with 7, 8 and 9 at its corners.  
 Fill in the numbers 1, 2, 3, 4, 5 and 6 such that the sum on each side adds up to 23.

[3m]

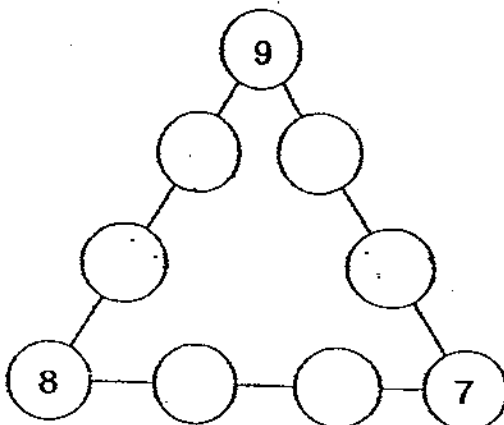

- 8 A circular garden of radius 4 m is surrounded by a path 1 m wide.
- (a) Find the circumference of the outer edge of the path. Leave your answer in terms of  $\pi$ .
- (b) Find the area of the path. Leave your answer correct to 2 decimal places.

Do not write  
in this space

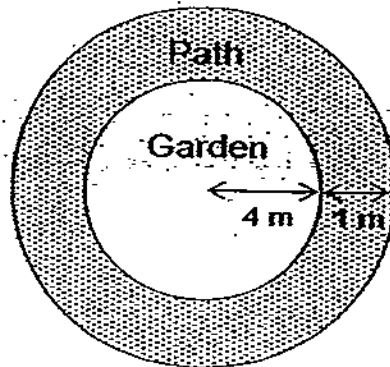

Ans: (a) \_\_\_\_\_ [1]

(b) \_\_\_\_\_ [2]

- 9 In the figure,  $ACD$  is a right-angled triangle.  
 $BC = BE$  and  $\angle CED = 80^\circ$ .  
 Find  $\angle DAC$ .

Do not write  
in this space

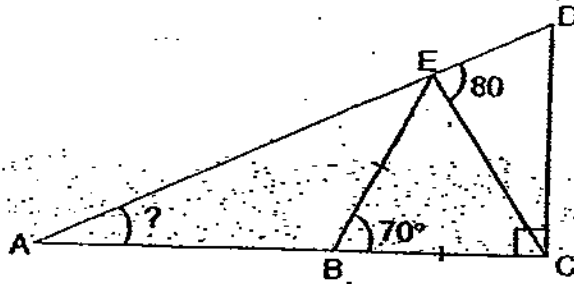

Ans: \_\_\_\_\_ [3]

10

$\frac{3}{5}$  of the pupils in School A are girls.

$\frac{2}{3}$  of the pupils in School B are girls.

There is an equal number of boys in School A and School B.

There are 400 more pupils in School B than School A.

Find the total number of pupils in the two schools.

Do not write  
in this space

Ans: \_\_\_\_\_ [3]

- 11 The pie chart below shows the different types of CCA a group of pupils participated in. 5 more pupils participated in Badminton than Athletics. How many pupils participated in Athletics?

Do not write in this space

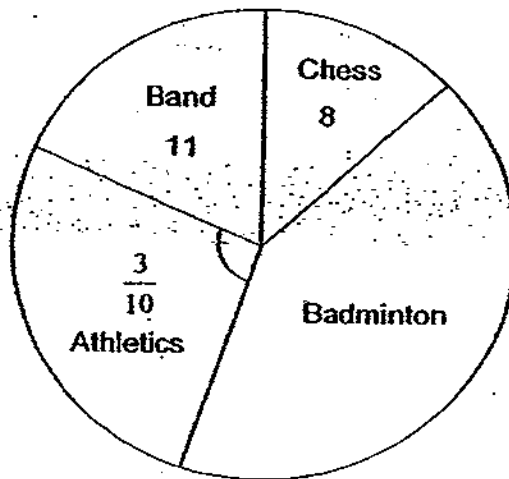

Ans: \_\_\_\_\_ [3]



- 12 Observe the pattern below. Each new stage is constructed by drawing squares around the sides of the squares in the previous stage.
- (a) Complete the figure for Stage 5. [1m]
- (b) Fill in the blanks in the table below. Write your answer in the space provided. [3m]

Do not write in this space

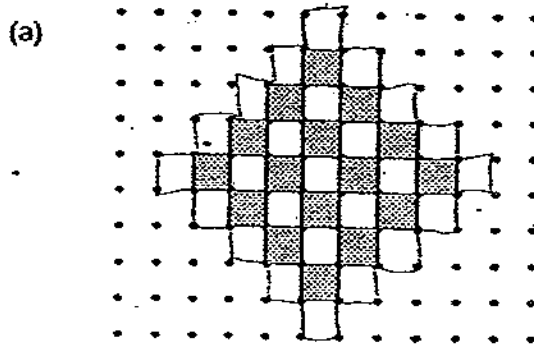
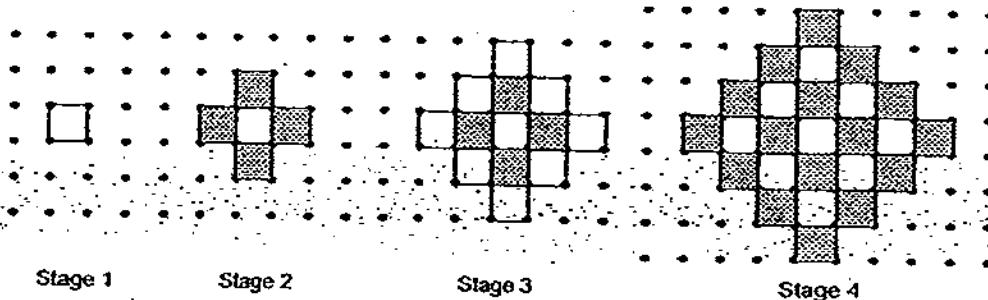

Stage 5

(b)

Stage Number	No. of squares in the middle row	No. of squares added	Total number of squares
1	1	0	1
2	3	4	5
3	5	8	13
4	7	12	25
5	9		41
...	...	...	...
10	(i)	36	(iii)

Ans: (i) \_\_\_\_\_ [1]

(ii) \_\_\_\_\_ [1]

(iii) \_\_\_\_\_ [1]

- 13 The ratio of the number of girls to the number of boys in the Rosyth AniManga Club last year was 3:2.  
When 24 girls joined the club this year, the ratio became 11:6.  
Find the number of girls in the club this year.

Do not write  
in this space

Ans: \_\_\_\_\_ [4]

- 14 The figure below is made up of a square and a circle.  
The side of the square is 14 cm.

Find the total area of the shaded parts. (Take  $\pi = \frac{22}{7}$ ).

Do not write  
in this space

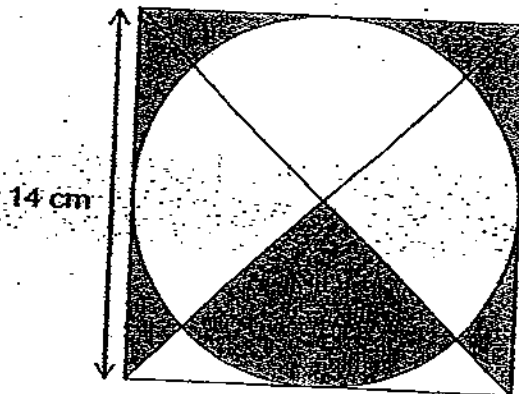

Ans: \_\_\_\_\_ [4]

**15** 800 people attended a concert.

The cost of a child ticket is  $\frac{3}{4}$  the cost of an adult ticket.

The total amount collected from the ticket sales was \$9472.

If 240 children attended the concert, how much was the cost of an adult ticket?

Do not write  
in this space

Ans: \_\_\_\_\_ [5]

16

In the diagram below, ABCD is a rectangular piece of card with  $AB = 30\text{ cm}$  and  $BC = 21\text{ cm}$ .

After the 4 shaded squares are cut-off, the remaining piece is folded along the dotted line to make an open-box with a rectangular base PQRS.

- (a) What is the length of PQ?
- (b) Find the volume of the open box.
- (c) If 2-cm cubes are put into the box, what is the maximum number of cubes that can be put into the box?

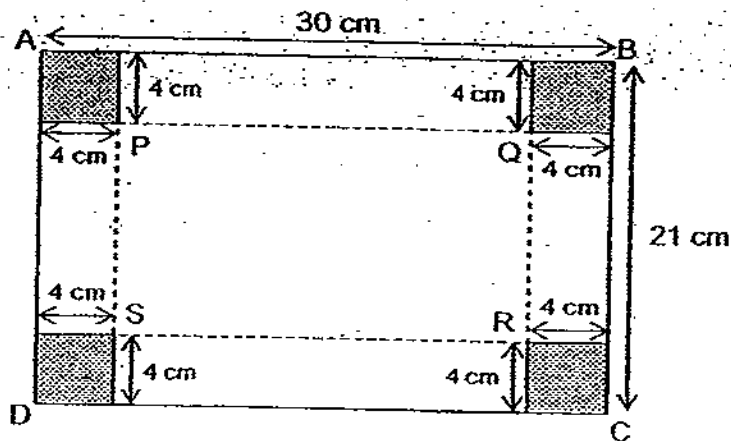

Do not write  
in this space

Ans: (a) \_\_\_\_\_ [1]

(b) \_\_\_\_\_ [2]

(c) \_\_\_\_\_ [2]

17

Mrs Wong has 2000 plants in her farm.

65% of the plants were orchids and rest were roses.

After some orchids were sold, and some roses were added, the percentage of orchids became 45% of the all the plants in the farm.

Given that 125 roses were added, how many orchids did she sell?

Do not write  
in this space

Ans: \_\_\_\_\_ [5]

18

Aaron and Kumar took part in a 24 km marathon.

Aaron ran half the distance at a speed of 10 km/h and jogged the rest of the way at a speed of 8 km/h.

Kumar ran half of his total time at 12 km/h and jogged the rest of the time at 6 km/h.

If they started the marathon at 8 am, at what time would each of them finish?

: Aaron: \_\_\_\_\_ }  
Kumar: \_\_\_\_\_ } [5 m]

End of Paper



# ANSWER SHEET

## EXAM PAPER 2009

SCHOOL : ROSYTH PRIMARY  
SUBJECT : PRIMARY 6 MATHEMATICS

TERM : SA2

Q1	Q2	Q3	Q4	Q5	Q6	Q7	Q8	Q9	Q10	Q11	Q12	Q13	Q14	Q15
1	2	2	3	3	4	2	3	1	2	2	2	2	4	4

16)84      17)3.08      18)6      19)154cm<sup>2</sup>      20)11

21)6 yr 6mth      22)E and N      23)8      24)\$33      25)10s

26)52°      27) 1/2      28)32cm      29)\$(20-3a/4)      30)600

### Paper 2

1)1800x4=7200 1200x2=2400 7200+2400=9600 =9.6kg	2)48 ÷ 30=1.6 1.6x85=136
3)320	4)\$25
5)(3x3) ÷ 4x( 1/2 x4x1)=9+8 =17cm <sup>2</sup>	6)80x4=320 320-95-85-95+23=68marks
7)      9 1            4 5            3 8    2    6    7	8)a)10Πm b)28.27m <sup>2</sup>

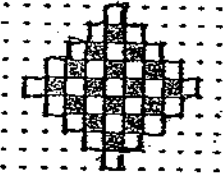

<p>9) <math>180^\circ - 70^\circ = 110^\circ</math>  <math>110^\circ \div 2 = 55^\circ</math>  <math>90^\circ - 55^\circ = 35^\circ</math>  <math>180^\circ - 80^\circ - 55^\circ = 45^\circ</math>  <math>180^\circ - 70^\circ = 110^\circ</math>  <math>180^\circ - 45^\circ - 110^\circ = 25^\circ</math>  <math>\angle DAC</math> is <math>25^\circ</math></p>	<p>10) 4400</p>
<p>11) <math>11 + 8 + 5 = 24</math>  <math>24 \div 4 = 6</math>  <math>6 \times 3 = 18</math>  18 pupils participated in Athletics.</p>	<p>12)a)   Stage 5</p> <p>b)i)16 ii)19 iii)181</p>
<p>13) <math>11 - 9 = 2</math>  <math>24 \div 2 = 12</math>  <math>12 \times 11 = 132</math>  There are 132 girls.</p>	<p>14) <math>14 \times 14 = 196</math>  <math>22/7 \times 1/4 \times 7 \times 7 = 38.5</math>  <math>22/7 \times 7 \times 7 = 154</math>  <math>196 - 154 = 42</math>  <math>42 \div 8 = 5.25</math>  <math>5.25 \times 6 = 31.5</math>  <math>31.5 + 38.5 = 70 \text{cm}^2</math></p>
<p>15) <math>240 \times 3 = 720</math>  <math>800 - 240 = 560</math>  <math>560 \times 4 = 2240</math>  <math>2240 + 720 = 2960</math>  <math>9472 \div 2960 = 3.20</math>  <math>3.20 \times 4 = 12.80</math>  The cost is \$3.20</p>	<p>16)a) <math>30 - 4 - 4 = 22</math>  The length is 22cm  b) <math>21 - 4 - 4 = 13</math>  <math>22 \times 13 \times 14 = 1144</math>  The volume is 1144cm<sup>3</sup>  c) <math>22 \div 2 = 11</math>  <math>13 \div 2 = 6R1</math>  <math>4 \div 2 = 2</math>  <math>11 \times 6 \times 2 = 132</math>  The maximum number is 132</p>

17)orchids  $65/100 \times 2000 = 1300$   
 $100 - 65 = 35$

Roses  $35/100 \times 2000 = 700$   
 $700 + 125 = 825$

$100 - 45 = 55$

$825 \div 55 = 15$

$15 \times 45 = 675$

$1300 - 675 = 625$

She sold 625 orchids.

18)a)10.42 am

b)10.40 am

