

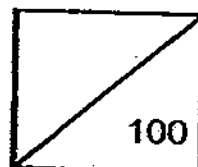

Rosyth School
Preliminary Examination for 2009
STANDARD SCIENCE
Primary 6

Total
Marks:



Name: _____

Class: Pr _____ Register No. _____

Duration: 1 h 45 min

Date: 28 August 2009

Parent's Signature: _____

BOOKLET A

Instructions to Pupils:

1. Do not open the booklets until you are told to do so.
2. Follow all instructions carefully.
3. This paper consists of 2 booklets, Booklet A and Booklet B.
4. For questions 1 to 30 in Booklet A, shade the correct ovals on the Optical Answer Sheet (OAS) provided using a 2B pencil.
5. For questions 31 to 46, give your answers in the spaces given in the Booklet B.

	Maximum	Marks Obtained
Booklet A	60 marks	
Booklet B	40 marks	
Total	100 marks	

* This booklet consists of 15 pages . (Pg. 1 to 15)

This paper is not to be reproduced in part or whole without the permission of the Principal.

Rosyth School/ Preliminary Examination/ Standard Science/P6/2009

3 The diagram below shows a seed which has been planted and stages in the growth of the seedling.

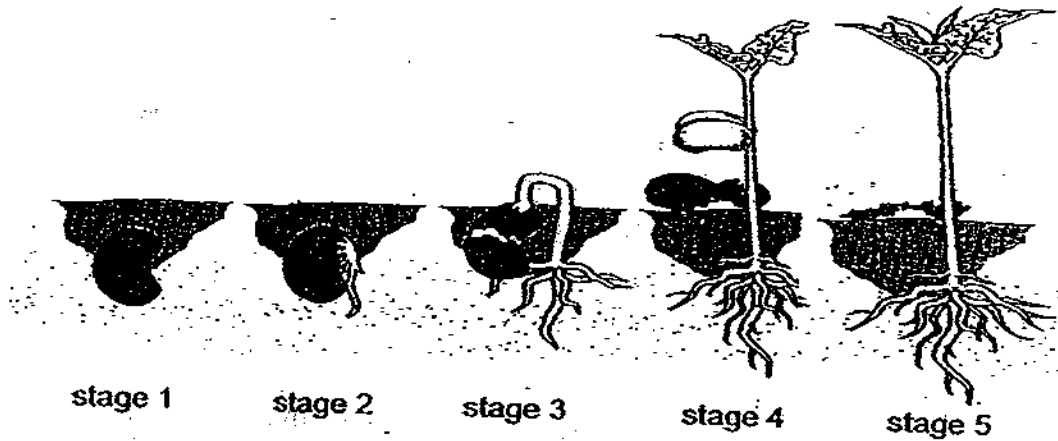

Which of the following stages show the changes that occur as a result of germination?

- (1) stage 1 to stage 2
- (2) stage 2 to stage 3
- (3) stage 3 to stage 4
- (4) stage 4 to stage 5

4 Study the classification chart below.

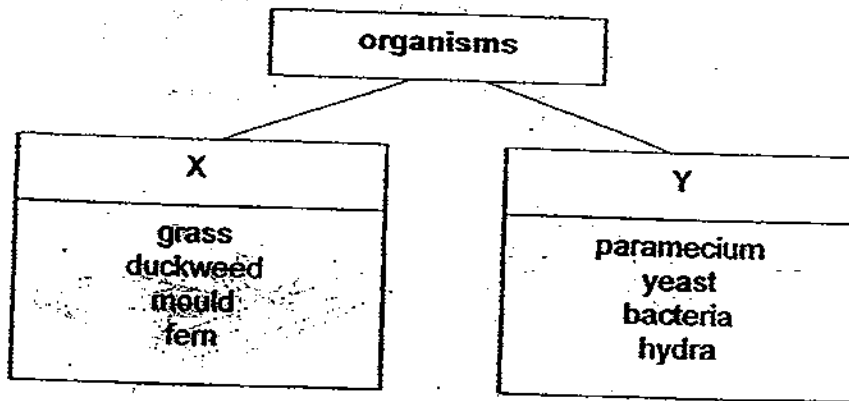

Which of the following are suitable headings for X and Y?

	X	Y
(1)	plants	animals
(2)	multicellular	unicellular
(3)	have chloroplast	do not have chloroplast
(4)	cannot move from place to place	can move from place to place

Rosyth School/ Preliminary Examination/ Standard Science/P6/2009

5 The diagram below shows the flower of a common type of grass which is pollinated by wind.



Which characteristic is the flower likely to have?

- (1) anthers with short filaments
- (2) nectaries producing nectar
- (3) short, unbranched stigmas
- (4) smooth and small pollen grains

6 Study the set-ups below.

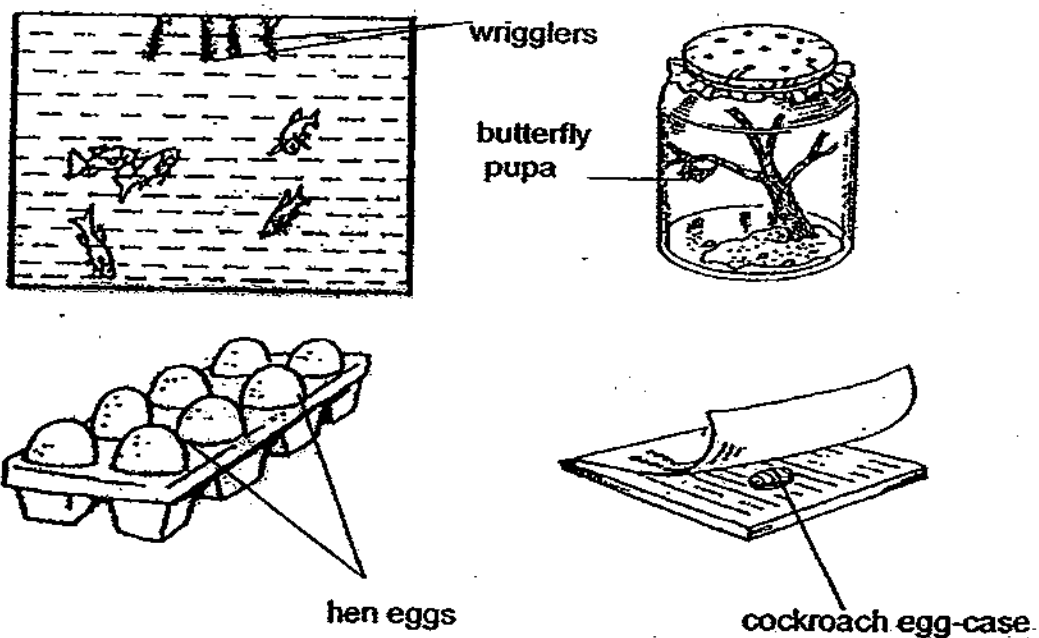

Which of the organisms would most likely develop to the next stage of their life?

- (1) wrigglers and hen eggs
- (2) hen eggs and cockroach eggs
- (3) wrigglers and butterfly pupa
- (4) butterfly pupa and cockroach eggs

Rosyth School/ Preliminary Examination/ Standard Science/P6/2009

7 The diagram below shows a pump and a spherical container.

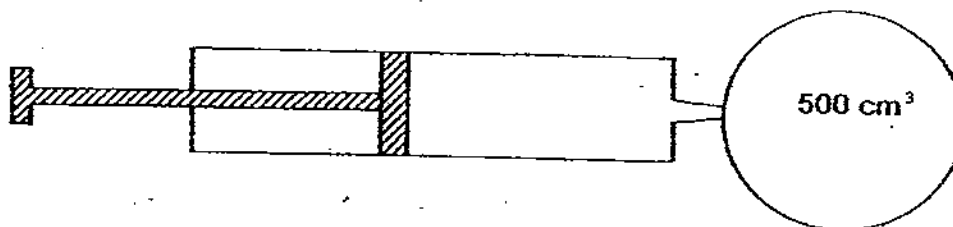

100 cm³ of air is forced into the metal container with each stroke of the pump. What will be the volume of the air in the container after 2 strokes of the pump?

- (1) 100 cm³
- (2) 200 cm³
- (3) 500 cm³
- (4) 700 cm³

8 A cup of hot boiling water and a cup of ice-cold water are covered and left on the table as shown in the diagram below.

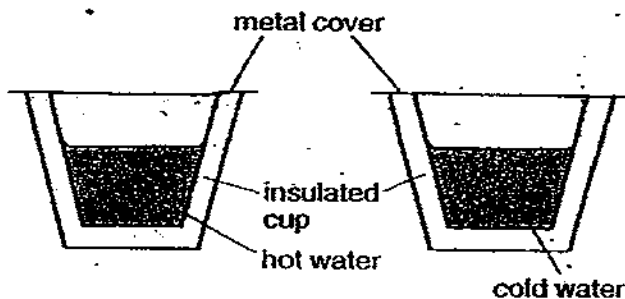

Which one of the following will be observed after 5 minutes?

- (1) (2)
- (3) (4)

Rosyth School/ Preliminary Examination/ Standard Science/P6/2009

9 The diagram below shows the lengths of the liquid mercury in a thermometer when placed in melting ice and above some boiling water.

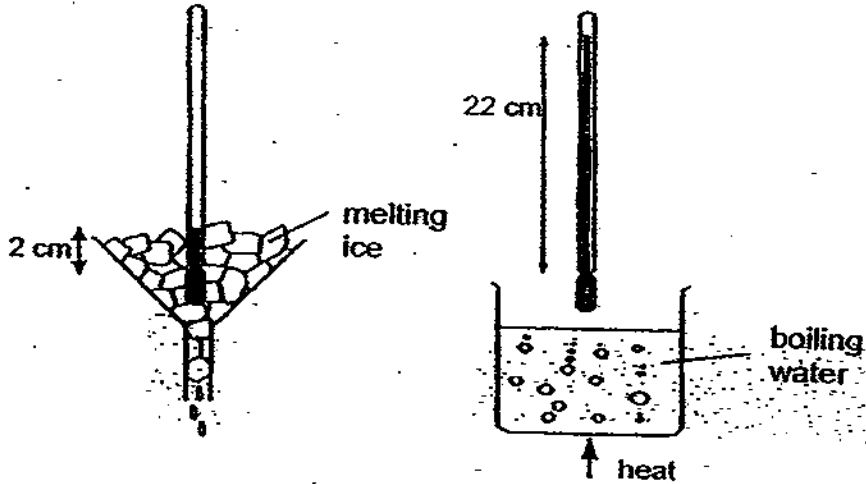

What is the distance between each 1°C mark on the thermometer?

- (1) 0.2 cm
- (2) 0.22 cm
- (3) 2.0 cm
- (4) 2.2 cm

10 Which of the following diagrams indicates the movement of food and water in a plant?

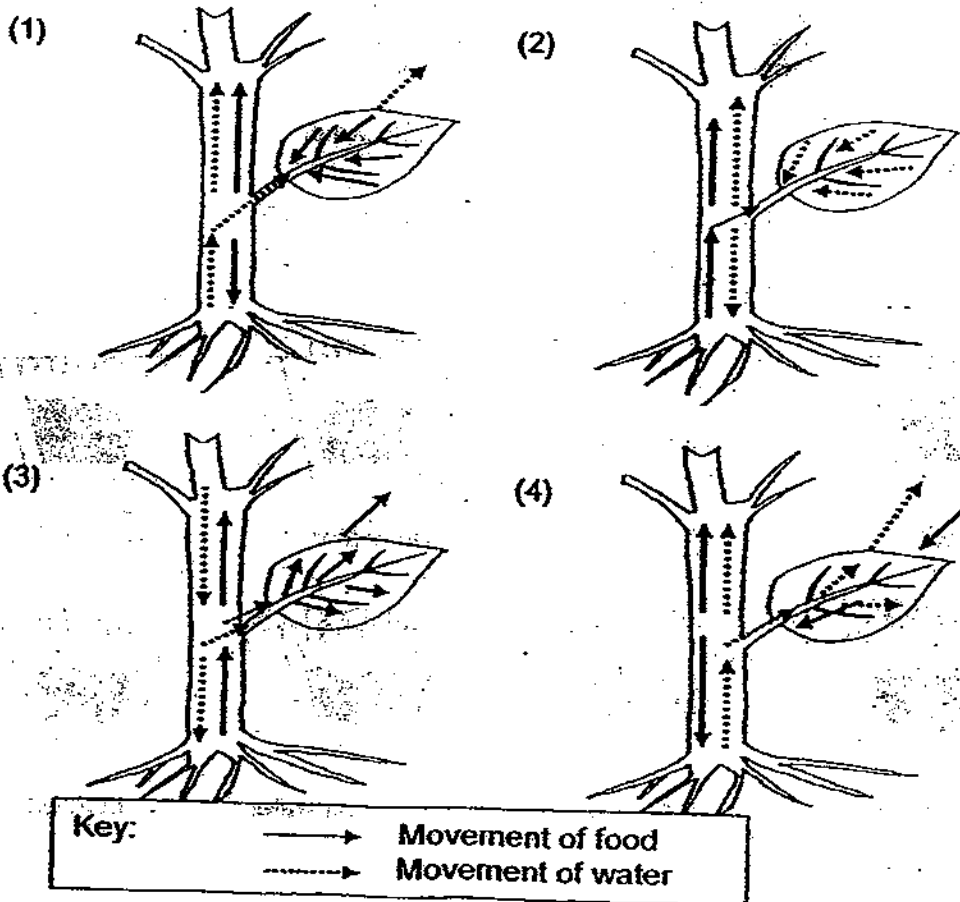

Rosyth School/ Preliminary Examination/ Standard Science/P6/2009

11 Study the graph shown in the diagram below.

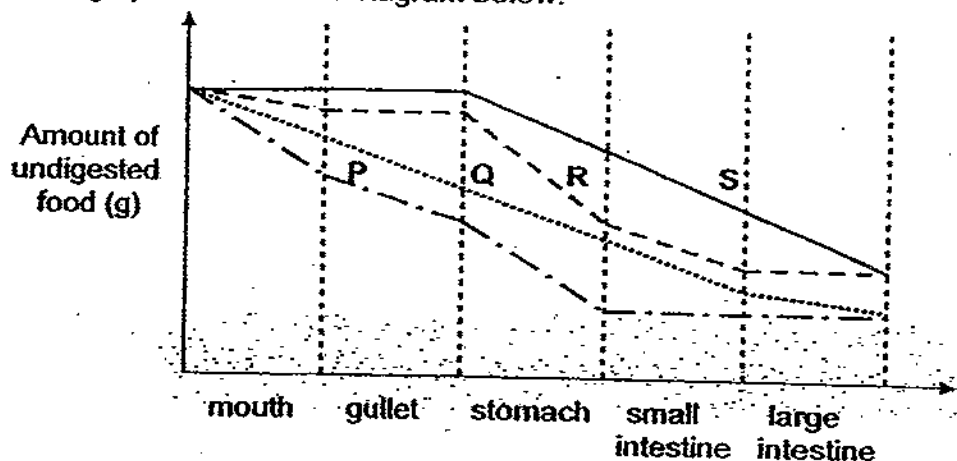

Which line correctly shows the relative amount of undigested food in the human digestive system?

- (1) P
- (2) Q
- (3) R
- (4) S

12 The diagram below shows the bones on a human arm.

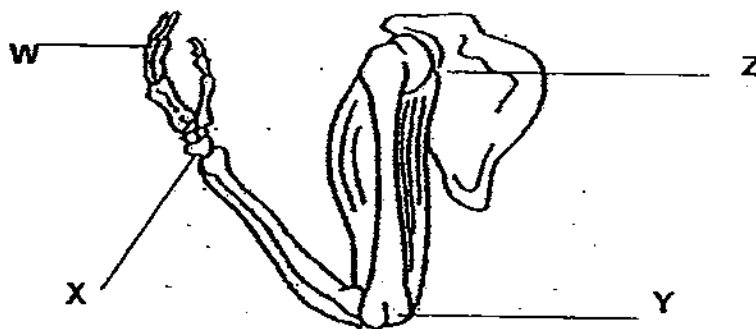

Which one of the joints gives the greatest freedom of movement?

- (1) W
- (2) X
- (3) Y
- (4) Z

13 Which is the route that can be taken by the blood travelling from a leg to an arm in the human body?

- (1) leg → lungs → heart → arm
- (2) leg → heart → lungs → arm
- (3) leg → lungs → heart → lungs → arm
- (4) leg → heart → lungs → heart → arm

Rosyth School/ Preliminary Examination/ Standard Science/P6/2009

14 Study the circuit diagram below.

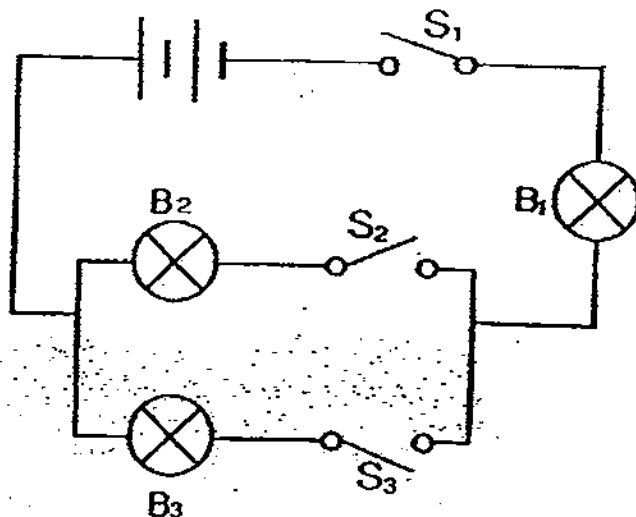

Which one of the following statements about the circuit is correct?

- (1) B_1 will light up when either B_2 or B_3 are lighted.
- (2) Electricity will flow as long as one switch is closed.
- (3) At least one bulb will light up when only S_1 is closed.
- (4) Electricity will flow only when all the switches are closed.

15 The diagram shows identical bulbs X and Y connected in series with two batteries. The bulbs light with equal brightness.

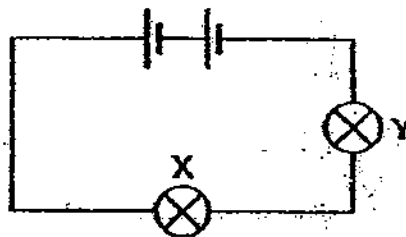

A third bulb Z is connected in parallel with bulb X as shown in the diagram below.

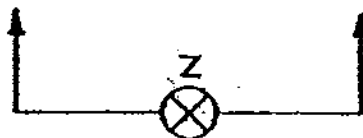

What happens to bulb Y?

- (1) It is as bright as before.
- (2) It does not light up.
- (3) It is dimmer than before.
- (4) It is brighter than before.

Rosyth School/ Preliminary Examination/ Standard Science/P6/2009

16 Peter carried out an experiment as shown in the diagram below.

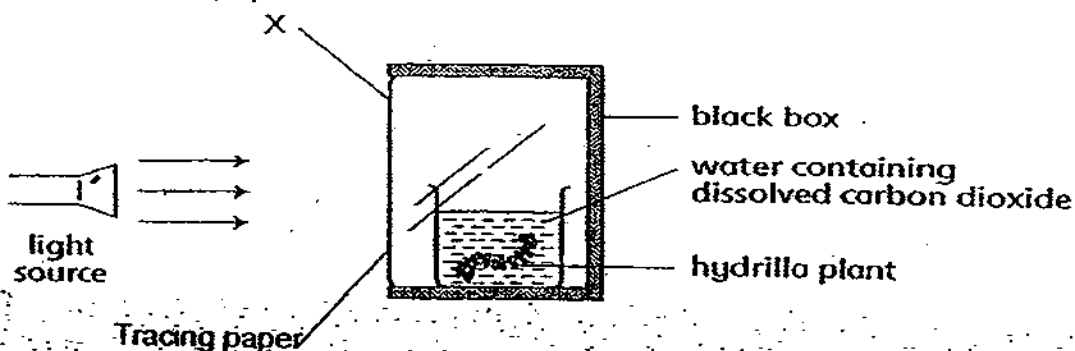

He placed one piece of tracing paper at position X and switched on the torch light for 10 minutes. He observed and recorded the number of bubbles produced by the hydrilla plant. He then repeated the experiment with two, three and four pieces of tracing paper.

Which of the following aims is/are suitable for his experiment?

- A To find out if plants need light to photosynthesize.
- B To find out how the intensity of light would affect the rate of photosynthesis of plants.
- C To find out if dissolved carbon dioxide would affect the rate of photosynthesis.
- D To find out how the number of bubbles produced by the plants is affected by the number of pieces of tracing paper.

- (1) B only
- (2) C only
- (3) A and C only
- (4) B and D only

17 The surfaces of all the leaves of a hibiscus plant were completely covered with a layer of cooking oil. After a few weeks, the plant died.

What could be the possible reasons for the plant to die?

- A Exchange of gases could not take place in the leaves.
- B The leaves were not able to take in water for photosynthesis to take place.
- C The leaves were not able to absorb the light energy to make food.
- D The leaves were not able to transport the food down to the other parts of the plant.

- (1) A only
- (2) C only
- (3) A and C only
- (4) B and D only

Rosyth School/ Preliminary Examination/ Standard Science/P6/2009

- 18 A group of biotechnologists used cells from an animal and a plant to study the information that can be passed on from parents to their offspring, as shown in the diagrams below.

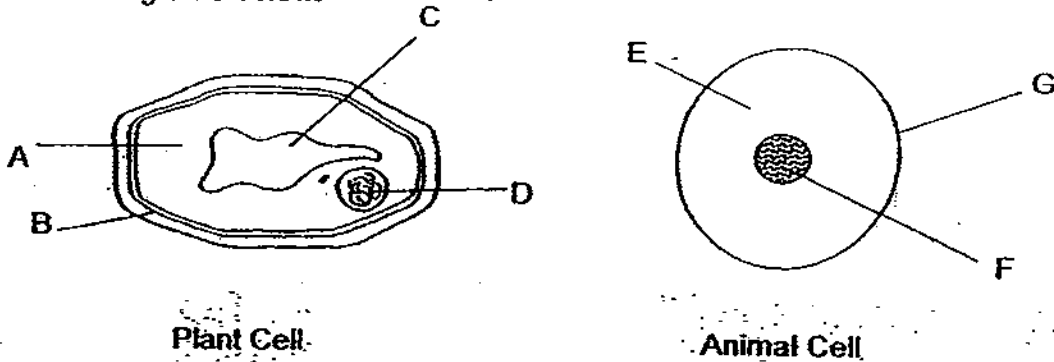

Which of the following parts should the biotechnologists focus on for their research?

- (1) A and E
 (2) B and G
 (3) C and F
 (4) D and F
- 19 Some pupils wanted to find out if light can pass through some materials. They carried out the following experiment in a dark room.

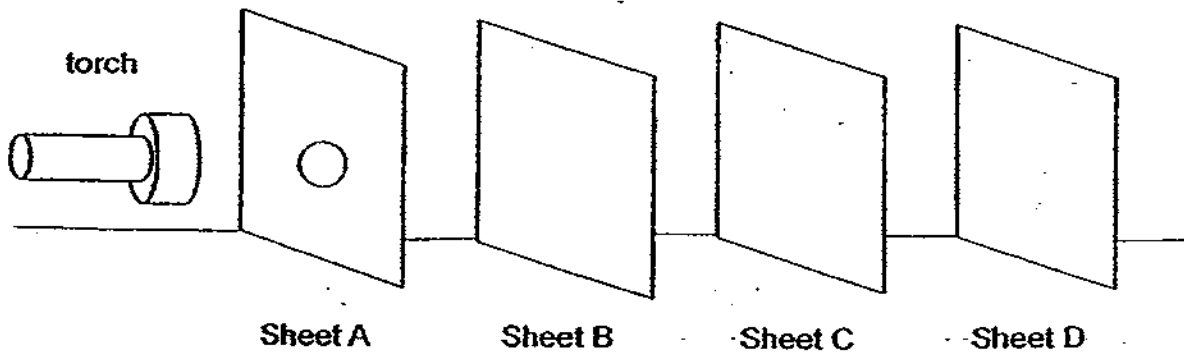

Sheets A, B, C and D are arranged in a straight line. Sheet A has a circular hole as shown above. When the torch is switched on, a bright circular patch of light is observed on Sheet C.

Which one of the following correctly describes the properties of the materials that sheets A, B, C and D are made of?

	Allows light to pass through	Does not allow light to pass through	Not possible to tell
(1)	A	C	B and D
(2)	A	C and D	B
(3)	B	C	A and D
(4)	B	A and C	D

Rosyth School/ Preliminary Examination/ Standard Science/P6/2009

- 20 Some pupils predicted that water will evaporate faster if the surrounding air temperature is higher.

To investigate their prediction they placed some water in two identical containers in two different rooms. They recorded the mass of the water and the container in room 1 and room 2 daily for 5 days.

The table below shows their results.

Time (days)	Mass of the container and water(g)	
	Room 1	Room 2
0	100	100
1	92	85
2	81	72
3	72	53
4	63	45
5	45	32

Why is the data shown in their table is not sufficient to test their prediction?

- (1) They did not measure the rate of evaporation
 - (2) They did not measure the temperatures of the two rooms
 - (3) They did not measure the volume of the water in the two containers for five days
 - (4) They did not measure the mass of the two containers in the beginning of the experiment
- 21 The four actions, A, B, C and D, below involve different energy changes.

- A Releasing a toy car down a ramp
 B Switching on a television set
 C Stretching a rubber band
 D Burning of charcoal

Which of the following processes are correctly matched with their energy conversions?

Processes	Energy Conversions
A	Potential energy \longrightarrow kinetic energy + heat + sound
B	Kinetic energy \longrightarrow electrical energy + light + sound + heat
C	Potential energy \longrightarrow kinetic energy
D	Potential energy \longrightarrow heat + light

- (1) A and B only
- (2) A and D only
- (3) A, C and D only
- (4) A, B, C and D

Rosyth School/ Preliminary Examination/ Standard Science/P6/2009

- 22 A group of pupils carried out an experiment using the set-up as shown below. A load is tied to a 1-metre long ruler at point X. The distance between the load and the fulcrum is y cm. An effort is applied downwards at point Z using weights placed on the scale pan which weighs 10g when empty.

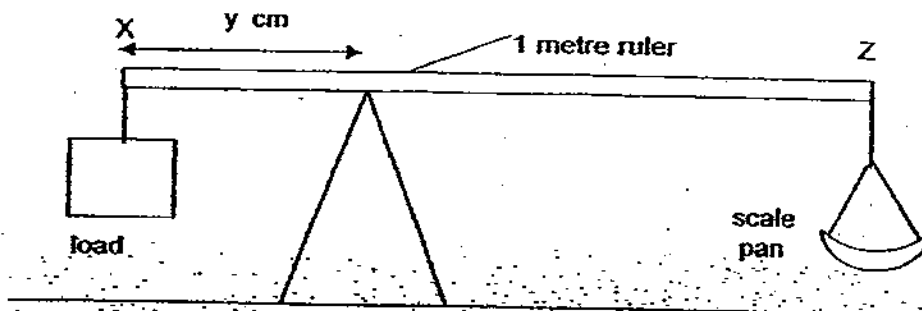

They obtained the results as shown in the table below.

y (cm)	Weight at Z (N)
10	2
20	17
30	36
50	132

Based on the data obtained, which of the following statements are correct?

- A The load is 122g.
 B The further away the scale pan is from the fulcrum, the greater the weight.
 C The effort needed to balance the lever depends on the position of the fulcrum.
 D As the distance between the load and fulcrum increases, the weight placed on the pan increases.

(1) B and D only

(2) ~~X~~ C and D only

(3) B, C and D only

(4) A, B, C and D

Rosyth School/ Preliminary Examination/ Standard Science/P6/2009

23. A load was pulled up along three ramps, A, B and C respectively.

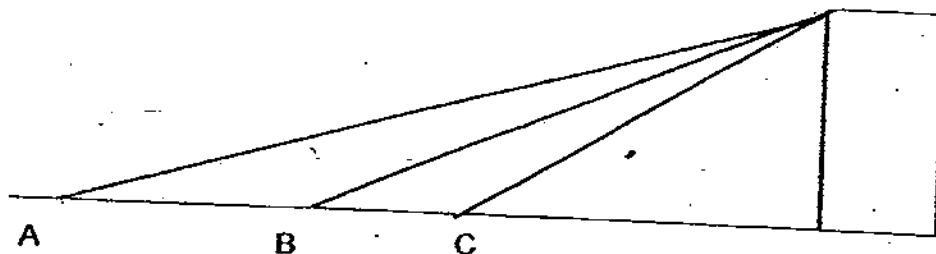

In which ramps will the effort be lesser than the load?

- (1) A only
- (2) B only
- (3) B and C only
- (4) A, B and C

24. The diagram below shows the Sun and the Earth. The place at which Annie is standing is about to experience sunset. At which position, 1, 2, 3 or 4, is she most likely at now?

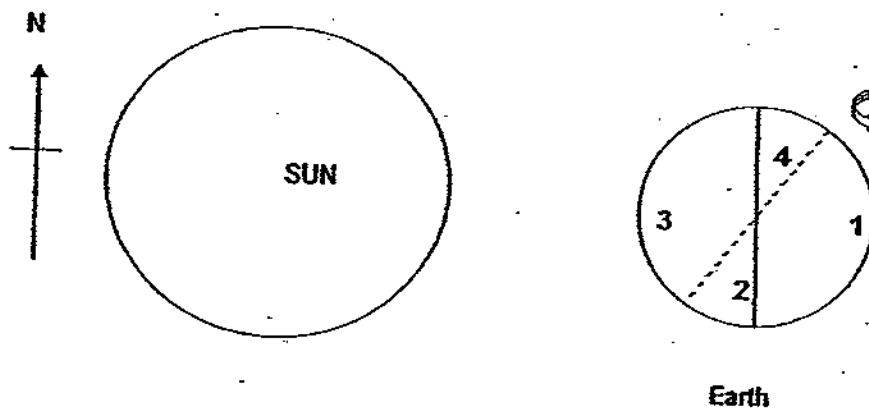

Rosyth School/ Preliminary Examination/ Standard Science/P6/2009

25 Amanda carried out an experiment to find out whether the slope of a ramp affected the distance the ball was moved by the force of a toy car rolling down the slope.

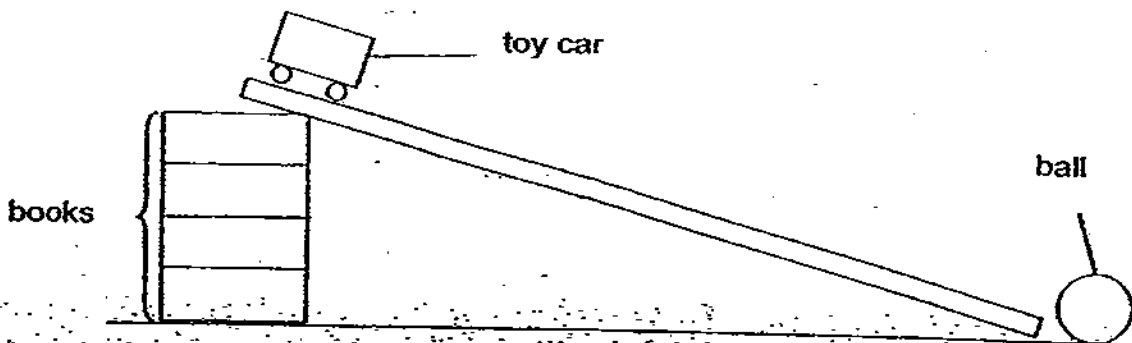

Which of the following variables must she keep the same in order to have a fair test?

- A Number of books
- B Length of ramp
- C Position the toy car is released
- D Distance moved by the ball

- (1) A and C only
- (2) A, B and C only
- (3) B, C and D only
- (4) A, B, C and D

26 Mary hung 4 metal bars from a rod and they moved in different directions as shown in the diagram below.

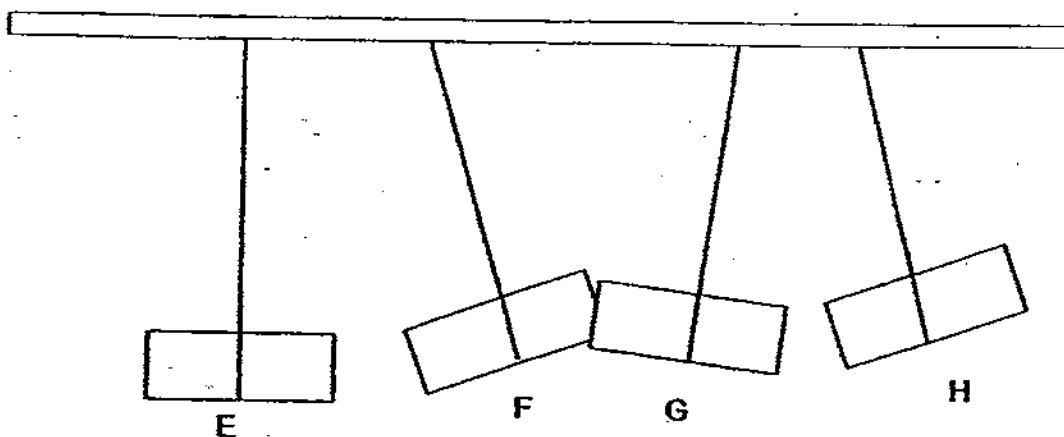

Which two of the metal bars are most likely to be magnets?

- (1) E and F
- (2) E and ~~B~~^H
- (3) F and G
- (4) G and H

Rosyth School/ Preliminary Examination/ Standard Science/P6/2009

- 27 Six bar magnets with their ends marked A to L can be arranged as shown below.

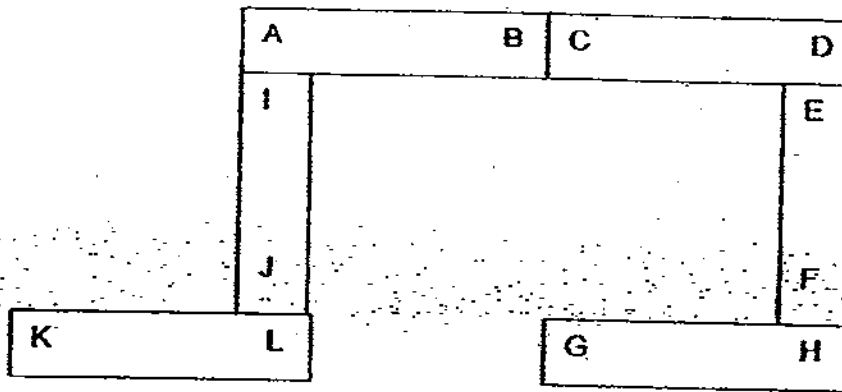

If 3 of the magnets are selected at random, which of the following diagrams shows a possible arrangement of the magnets?

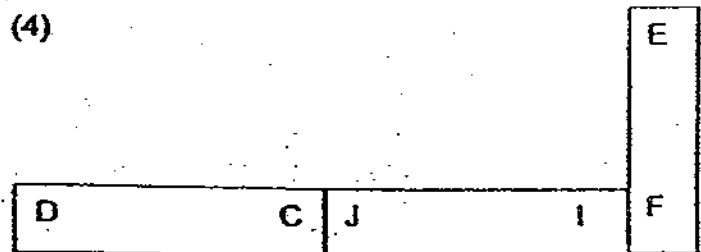
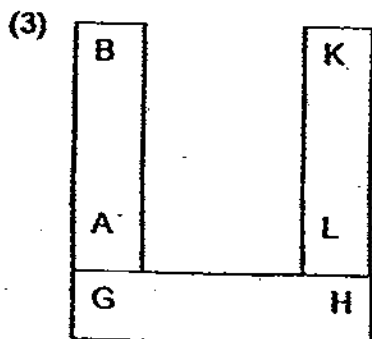
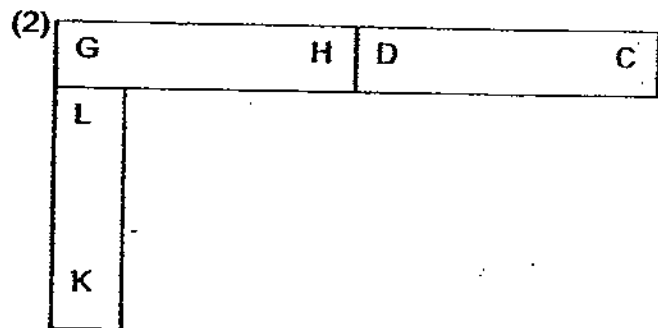
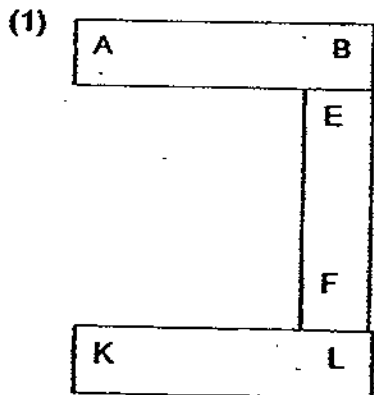

Rosyth School/ Preliminary Examination/ Standard Science/P6/2009

28 Which of the following animals help to break up dead matter into smaller pieces so that decomposers can decompose them faster?

- A Earthworm
- B Termite
- C Vulture
- D Fungi

- (1) D only
- (2) A and C only
- (3) A, B and C only
- (4) A, B, C and D

29 Study the food chain given below.



Which one of the following graphs best illustrates what would happen to the population of mice if the population of the snakes was suddenly wiped out?

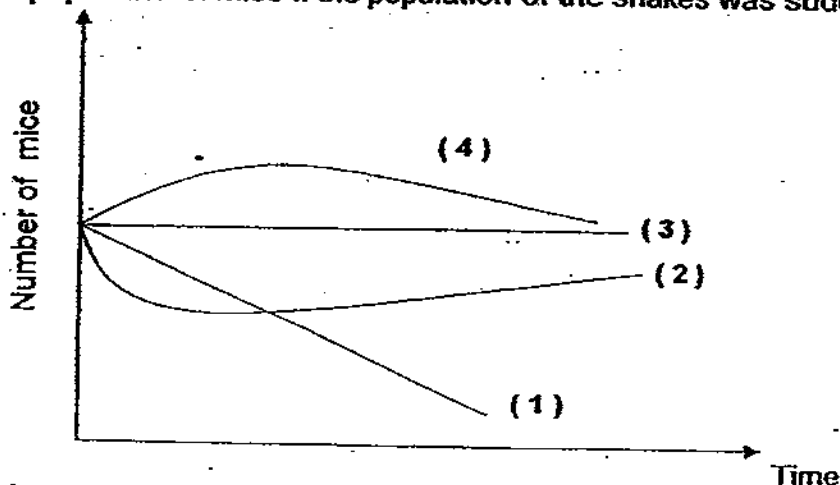

30 In a documentary, Jane learnt that the type of waste material disposed by man can have a negative impact on our environment.

Which of the following are the possible reasons for the negative impact?

- A Non-biodegradable materials will remain as litter in the environment.
- B Living things may die if they swallow or get entangled in the materials.
- C Animals can get sick if they breathe in the poisonous gas produced by some materials when burnt.
- D Biodegradable materials can cause pollution as they give off a bad smell during decomposition, contaminating the environment.

- (1) A and C only
- (2) B and D only
- (3) A, B and C only
- (4) A, B, C and D

End of Booklet A



Rosyth School
Preliminary Examination for 2009
STANDARD SCIENCE
Primary 6

Total
Marks:

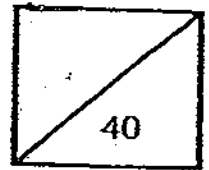

Name: _____

Class: Pr _____

Register No. _____

Duration: 1 h 45 min

Date: 28 August 2009

Parent's Signature: _____

BOOKLET B

Instructions to Pupils:

1. For questions 31 to 46, give your answers in the spaces given in this Booklet B.

* This booklet consists of 13 pages. (Pg. 16 to 28)

This paper is not to be reproduced in part or whole without the permission of the Principal.

PART II

For questions 31 to 46, write your answers in this booklet.

- 31 Pele carried out an experiment in the science lab on four powdery substances to find out how soluble each substance was in water. The table below shows the results he had obtained.

Substance	A	B	C	D
Amount of substance that could dissolve in 500 cm ³ of water (teaspoons)	9	0	21	15

- (a) Besides using the same container to hold the water, write down another variable that must be kept the same in this experiment. [1]

- (b) The four substances A, B, C and D are found as stains on a cloth as shown in the diagram below.

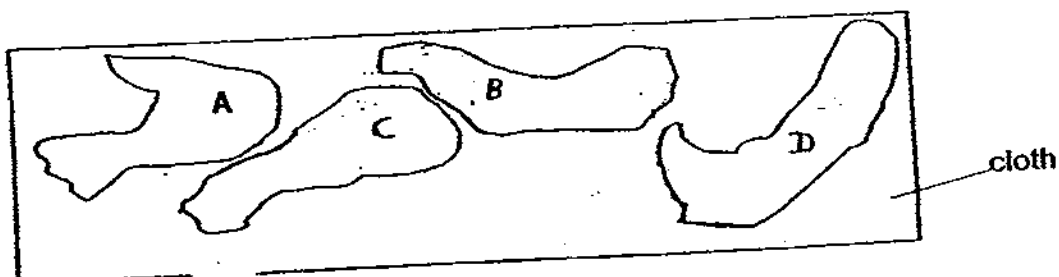

The stained cloth was soaked overnight in water. Shade the area that would remain stained and explain your answer. [1]

Rosyth School/ Preliminary Examination/ Standard Science/P6/2009

32 The diagram below shows the fruit of a tree.

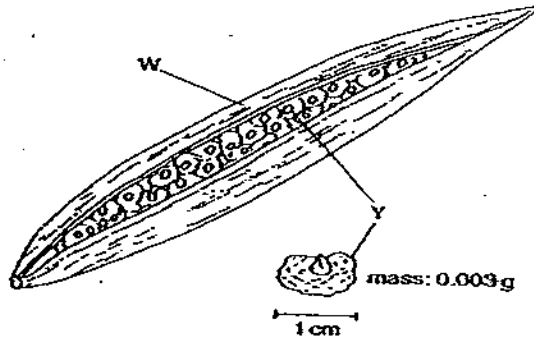

(a) Name the parts of the flower from which W and Y have developed respectively.

[1]

(b) Describe how the fruit disperses its seeds.

[1]

33 Sufen observed a cell found in a multi-cellular organism using a microscope.

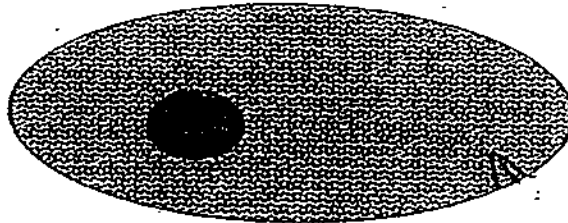

(a) Label the part of the cell where chemical reactions take place.

[1]

Sufen deduced that the cell above is definitely not a plant cell.

(b) What is the reason for her deduction?

[1]

(c) How will a plant be affected if all the cells are similar to the cell above?

[1]

Rosyth School/ Preliminary Examination/ Standard Science/P6/2009

- 34 The diagram below shows structures produced by the male reproductive organs of two different organisms.

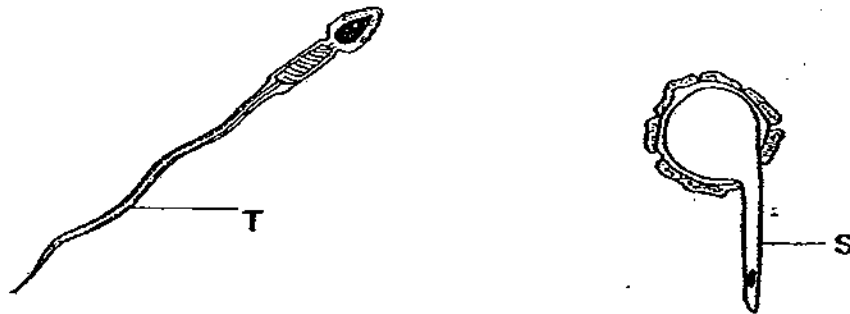

- (a) Describe the importance of part T and S in ensuring that fertilisation is successful.

[2]

Rosyth School/ Preliminary Examination/ Standard Science/P6/2009

- 35 In an experiment to find out the melting point of a substance, a thermometer is placed in a test-tube of hot liquid. The temperature of the liquid is recorded every half minute. The graph below shows the results.

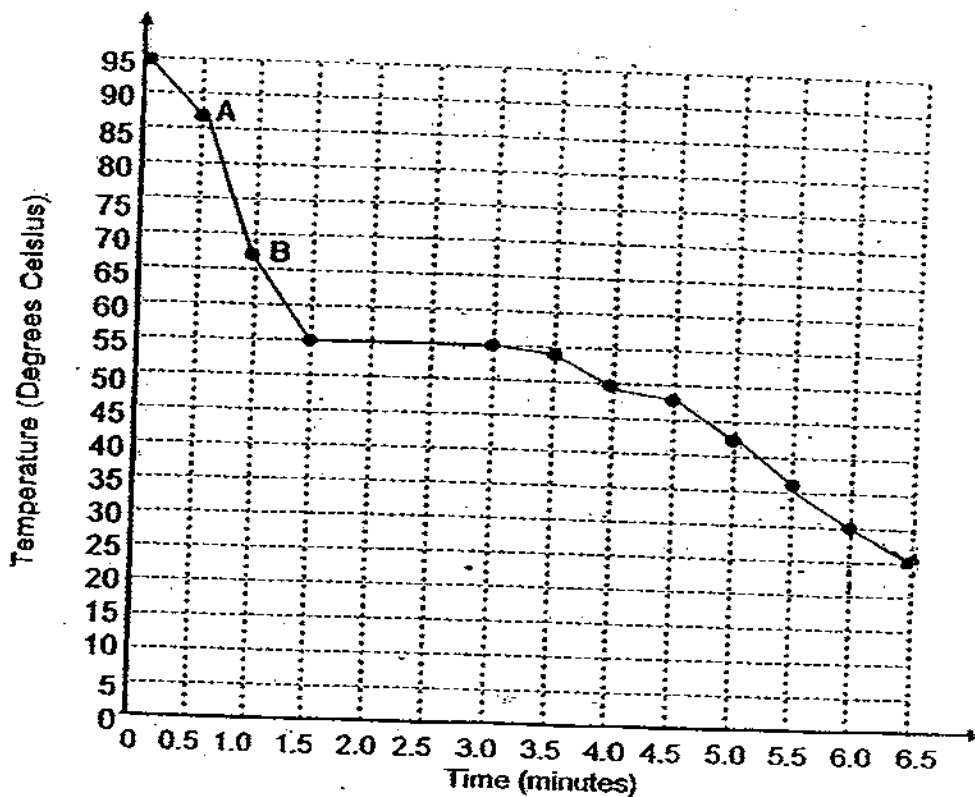

- (a) Put a cross (X) on a part of the graph when the whole substance has become a solid. [1]

- (b) What is the melting point of the substance? What is your reason for the choice? [1]

- (c) At which point, A or B, will you add an egg to cook it faster? Explain why. [1]

Rosyth School/ Preliminary Examination/ Standard Science/P6/2009

- 36 Mariam conducted an experiment using the three set-ups shown in the diagram below.

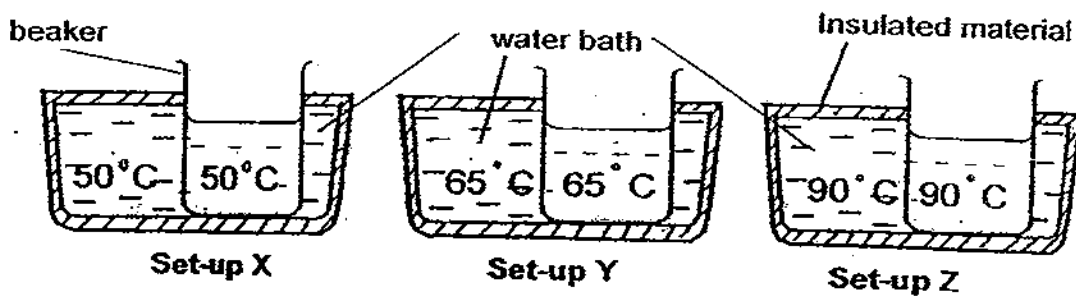

She showed the results of the experiment in the table below.

Set-ups	X	Y	Z
Initial amount of water in beaker (ml)	200	200	200
Temperature of water in beaker ($^{\circ}\text{C}$)	50	65	90
Temperature of water bath	50	65	90
Amount of water in beaker after 2 hours (ml)	197	190	180

- (a) What is the aim of her experiment?

[1]

- (b) What is the purpose of the water bath?

[1]

Rosyth School/ Preliminary Examination/ Standard Science/P6/2009

37 Maqipighi, a famous Italian scientist, peeled off the bark of a tree in a complete circle as shown in the diagram below.

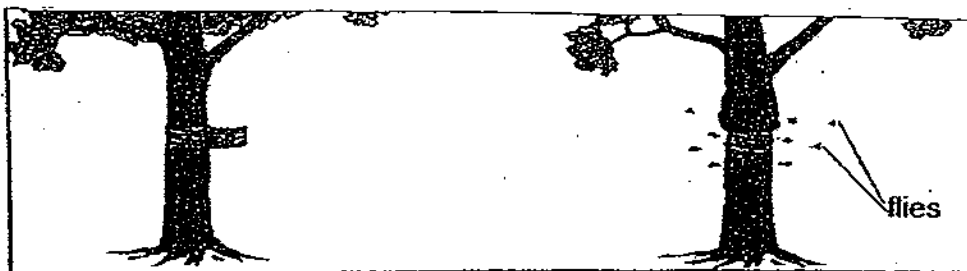

After a few days, he found a swelling above the stripped area with a sweet liquid leaking from it.

(a) What has been removed from the trunk of the tree together with the bark? [1]

(b) Would the tree survive? Explain your answer. [1]

38 Answer the following questions.

(a) Describe how our digestive system and circulatory system work together to ensure the survival of our body. [2]

(b) How do our skeletal system and the muscular system aid digestion? [2]

Rosyth School/ Preliminary Examination/ Standard Science/P6/2009

- 39 Bala set up the electrical circuit shown in the diagram below. He used a light sensor from a datalogger to measure the brightness of light given out by the bulb.

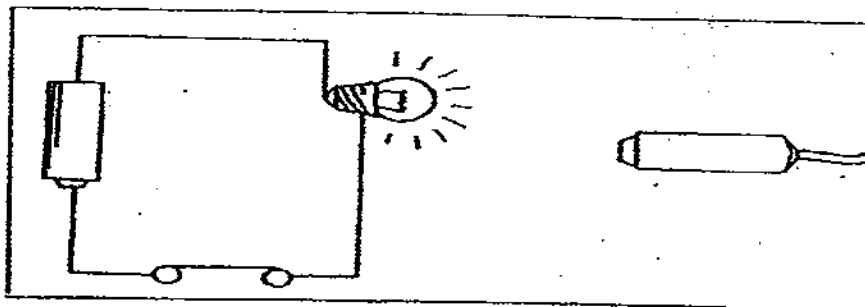

He increased the number of batteries used in the circuit and recorded the data he collected in the table shown below.

Number of batteries	Brightness of light (lux)
1	0.18
2	0.35
3	0.70
4	0.87
5	0.00

- (a) Explain the result he obtained when he used 5 batteries in the circuit. [1]

- (b) Draw a circuit diagram to show how he could use all the 5 batteries in the circuit to light up the bulb with the brightness of 0.18 lux. [1]

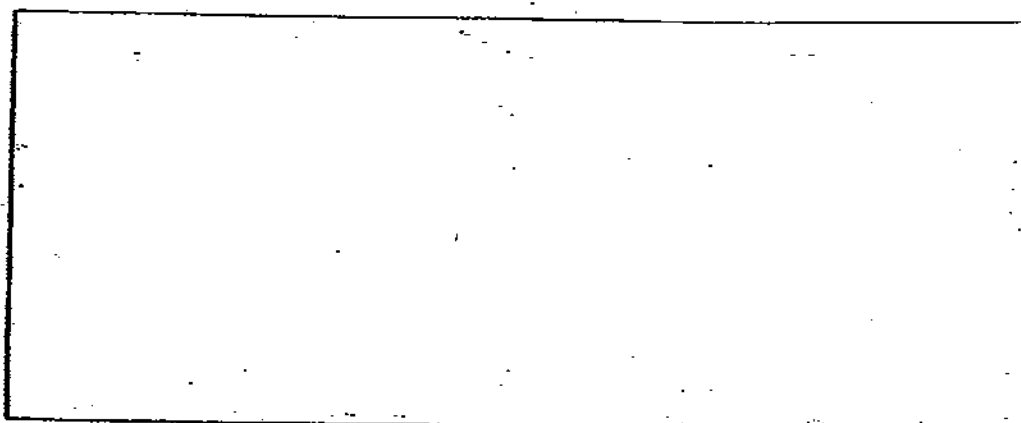

- (b) What is the advantage of using the set-up you have drawn in (b) compared to the original set-up using only one battery. [1]

Rosyth School/ Preliminary Examination/ Standard Science/P6/2009

- 40 David did a research and found out about a substance called Tar. He recorded his findings in a table below.

Condition	Property
Warm	Tar is soft.
Cool	Tar is hard

He also observed that some roads are made of concrete. The concrete is laid with small gaps between them as shown in the diagram below.

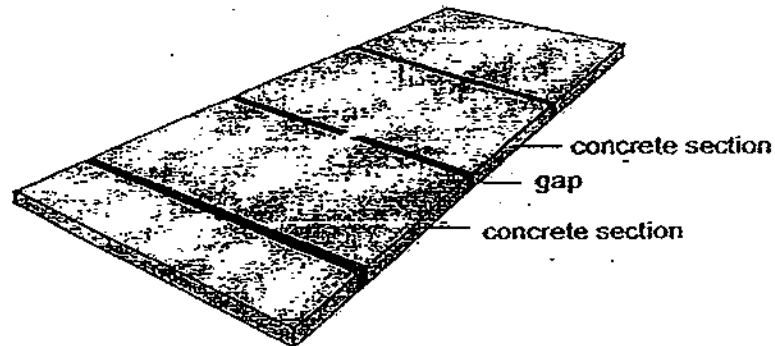

The gaps between the concrete sections are filled with tar.

Explain how tar is useful in concrete roads.

[2]

Rosyth School/ Preliminary Examination/ Standard Science/P6/2009

- 41 The diagram below shows two cyclists riding along a dark road at night. One is wearing black clothes and the other is wearing light-coloured clothes.

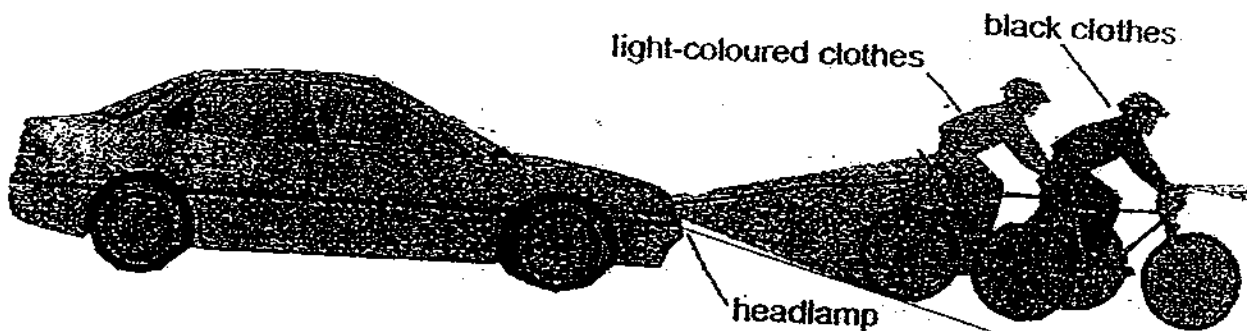

A man is driving a car behind the two cyclists. Light from the car headlamp shines on both the cyclists as shown above.

- (a) On the diagram above, draw a ray of light to show how light from the headlamp reaches the man so that he can see the cyclist in the light-coloured clothes. [1]
- (b) Why is the driver not able to see the cyclist wearing black clothes? [1]

- 42 The diagram below shows the effect of global warming on our environment.

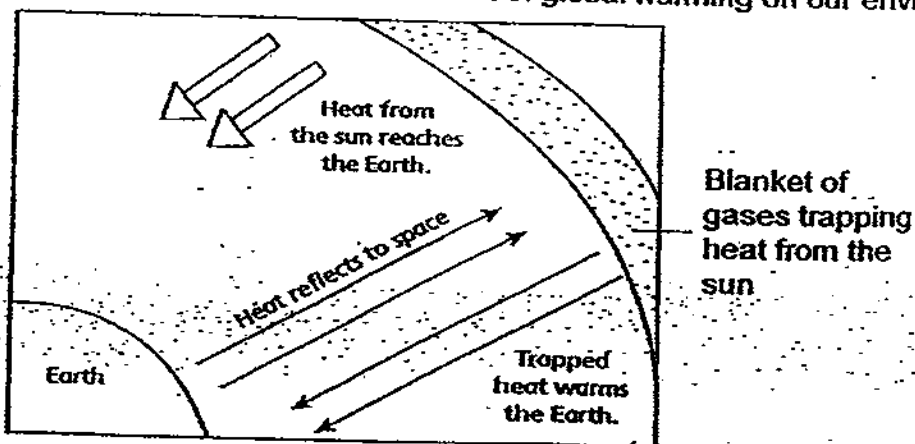

- (a) What are the 2 possible causes of global warming? [1]
- (b) State an effect of global warming. [1]

Rosyth School/ Preliminary Examination/ Standard Science/P6/2009

43 The leaves of the water lily are thin and broad.

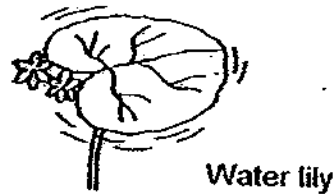

Water lily

(a) How do the above structural adaptations help the water lily plant survive in its environment? [1]

Look at the two fruits given below.



Angsana



Mango

(b) State their structural adaptations that help them to disperse their seeds. [2]

Fruits	Structural adaptations	Description of dispersal
Angsana		
Mango		

Rosyth School/ Preliminary Examination/ Standard Science/P6/2009

- 44 Mrs Tan had two cubes A and B. She carried out the following experiments to determine the properties of the materials.

Experiment 1

She applied a force to move cube A in the direction as shown below. Later, she replaced cube A with cube B and applied an equal force on it. She observed that cube A moved a greater distance than cube B.

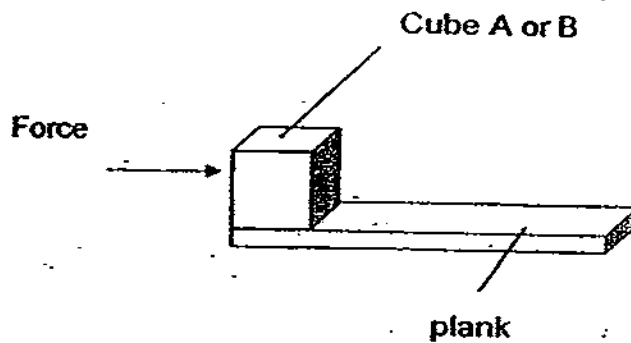

- (a) Identify the force(s) acting on the cube.

[1]

Experiment 2

Next, she moved a magnet under the plank for the two cubes one at a time. She observed that only cube B moved along with the magnet as shown in the diagram below.

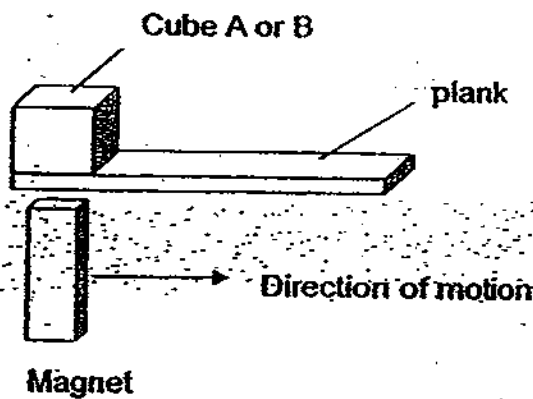

- (b) What can she conclude about the material of cube A and cube B?

[2]

Cube A: _____

Cube B: _____

Rosyth School/ Preliminary Examination/ Standard Science/P6/2009

45 Mary studied the two pulley systems as shown below.

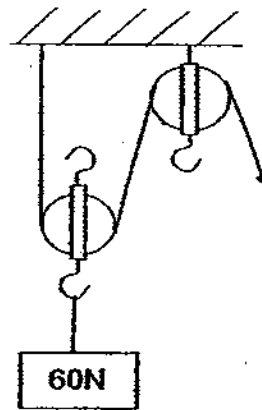
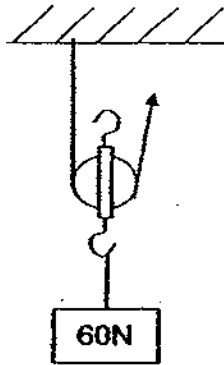

(a) What was the effort needed to overcome the load in Diagram A? [1]

(b) What was the advantage of adding a second pulley in Diagram B? [1]

She also observed that her mother arranged the heavier clothes nearer to the window as shown in Pole A.

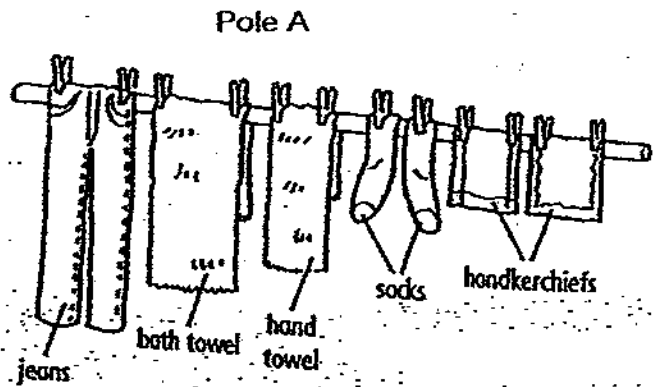
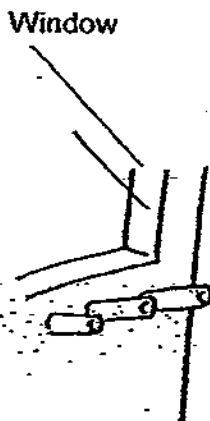

(c) Why do you think Mary's mother had arranged the clothes on the bamboo pole in that manner? [1]

Rosyth School/ Preliminary Examination/ Standard Science/P6/2009

- 46 Daniel carried out an experiment to find out how the length of the spring is affected by the number of marbles placed in the pan of the spring. The set-up for his experiment is shown below.

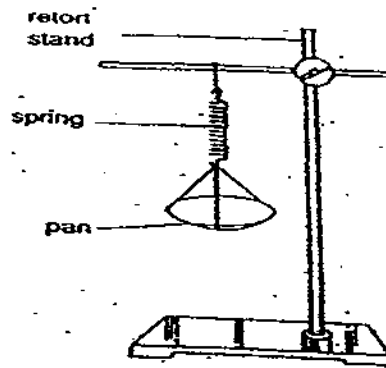

He placed different number of marbles in the pan each time and recorded his results in the table below.

Number of marbles	2	4	6
Length of spring / cm	8	12	16

- (a) What will be the length of the spring when the 6 marbles are removed? [1]

- (b) What is the relationship between the number of marbles and the potential energy of the spring? [1]

End of Booklet B

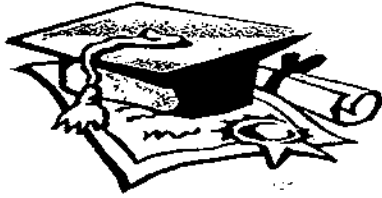

ANSWER SHEET

EXAM PAPER 2009

SCHOOL : ROSYTH PRIMARY
SUBJECT : PRIMARY 6 SCIENCE

TERM : SA2

Q1	Q2	Q3	Q4	Q5	Q6	Q7	Q8	Q9	Q10	Q11	Q12	Q13	Q14	Q15	Q16	Q17
4	4	1	4	4	4	3	1	1	1	3	4	4	1	1	4	1

Q18	Q19	Q20	Q21	Q22	Q23	Q24	Q25	Q26	Q27	Q28	Q29	Q30
4	4	2	2	2	4	2	1	4	3	3	4	4

31)a) Temperature of water.

b) B

B is not soluble.

32)a) W is developed from the ovary while Y is developed from the ovules.

b) It is dispersed by wind and by explosive action.

33)a)

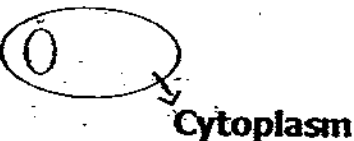

b) There is no cell wall found in the cell.

c) The plant would not be able to make food and it will not have its shape.

34)a) S is a pollen tube that grows from the pollen grain down the style to the ovary to enable the male gamete to fuse.

35)a)

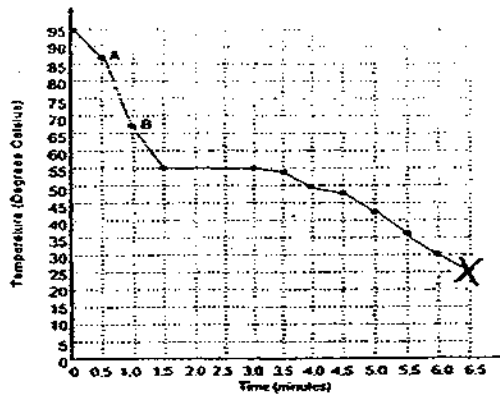

b) 55°C. The temperature remained constant for 1.5 minutes until the whole substance has become a solid.

c) A. There is more heat for the egg to cook faster.

36)a) To find out how the temperature of water affect the rate of evaporation of water.

b) To make sure that the water in the beaker is kept at a constant temperature.

37)a) The phloem has been removed.

b) The phloem cannot transport sugars through the bark to the roots. The roots used up their stored food so they cannot take in water so it will die.

38)a) The nutrient that was absorb from the food we eat is than collected by the blood vessels and than circulated around our body.

b) The teeth which belong to the skeletal system helps to break the food into smaller pieces the stomach is a muscular contracts and relaxes that churns the food. The gullet expand sand contracts to push into the stomach. Muscular move the lower jaw to chew the food.

39)a) The current supplied by five batteries connected in series was too strong and the filament in the bulb over heated and melted and cause not be lit .

39)b)

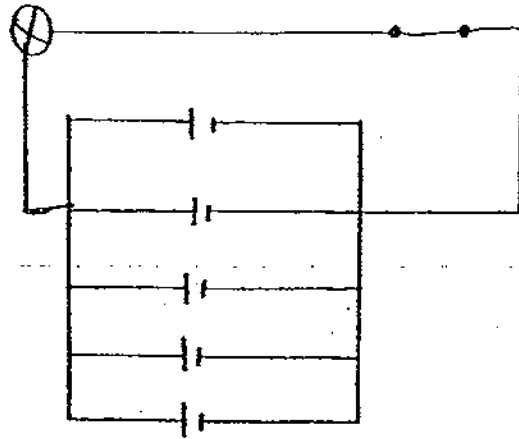

c) It provides lesser power so that the bulb would not blow and the battery can last longer.

40) On a hot day, tar gains heat and becomes soft. The concrete expands so it pushes the soft tar without cracking.

41)a)

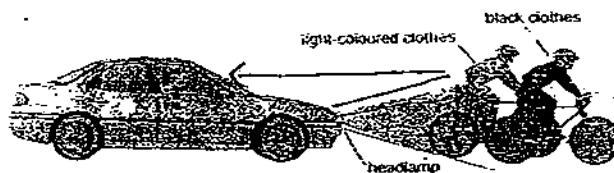

b) The cyclist which is wearing black clothes has black to absorb the light and not reflected to the driver's eyes.

42)a) Deforestation and and gases produce by factory's.

b) The ice at the North and south pole will melt which than sea levels will rise and it will flood the coastal region which lead to damage of property.

43)a) It allow the water lily to get sunlight easily and allows the water lily to stay afloat.

b) It has wing-like structure to fly away from the parent plant.
By wind.

Sweet juicy flesh.

The animal eats the sweet juicy flesh and throws the seed onto the ground.

44)a)Gravity force and frictional force.

b)A: It is a smooth and non-magnetic material.

B: It is a rough and magnetic material.

45)a)30N.

b)Load and effort move in opposite direction.

c)Putting the heavier load nearer the fulcrum would require less effort to hang out the pore of clothes.

46)a)4cm.

b)The more the number of marbles the higher the potential energy of the spring.

