

Index  
No.

**PEI CHUN PUBLIC SCHOOL**  
**PRELIMINARY EXAMINATION, 2016**

**SCIENCE**  
**SECTION A**

**Time: 1 h 45 min**

Name : \_\_\_\_\_ (    )

Class : Primary 6 \_\_\_\_\_

Date : 5 August 2016

Parent's Signature: \_\_\_\_\_

**INSTRUCTIONS TO CANDIDATES**

**DO NOT OPEN THIS BOOKLET UNTIL YOU ARE TOLD TO DO SO.**

**FOLLOW ALL INSTRUCTIONS CAREFULLY.**

**ANSWER ALL QUESTIONS.**

**WRITE YOUR ANSWERS IN THIS BOOKLET.**

**Section A (30 × 2 marks)**

For questions 1 to 30, choose the most suitable answer and shade its number (1, 2, 3 or 4) on the Optical Answer Sheet (OAS) provided.

1. Study the chart below.

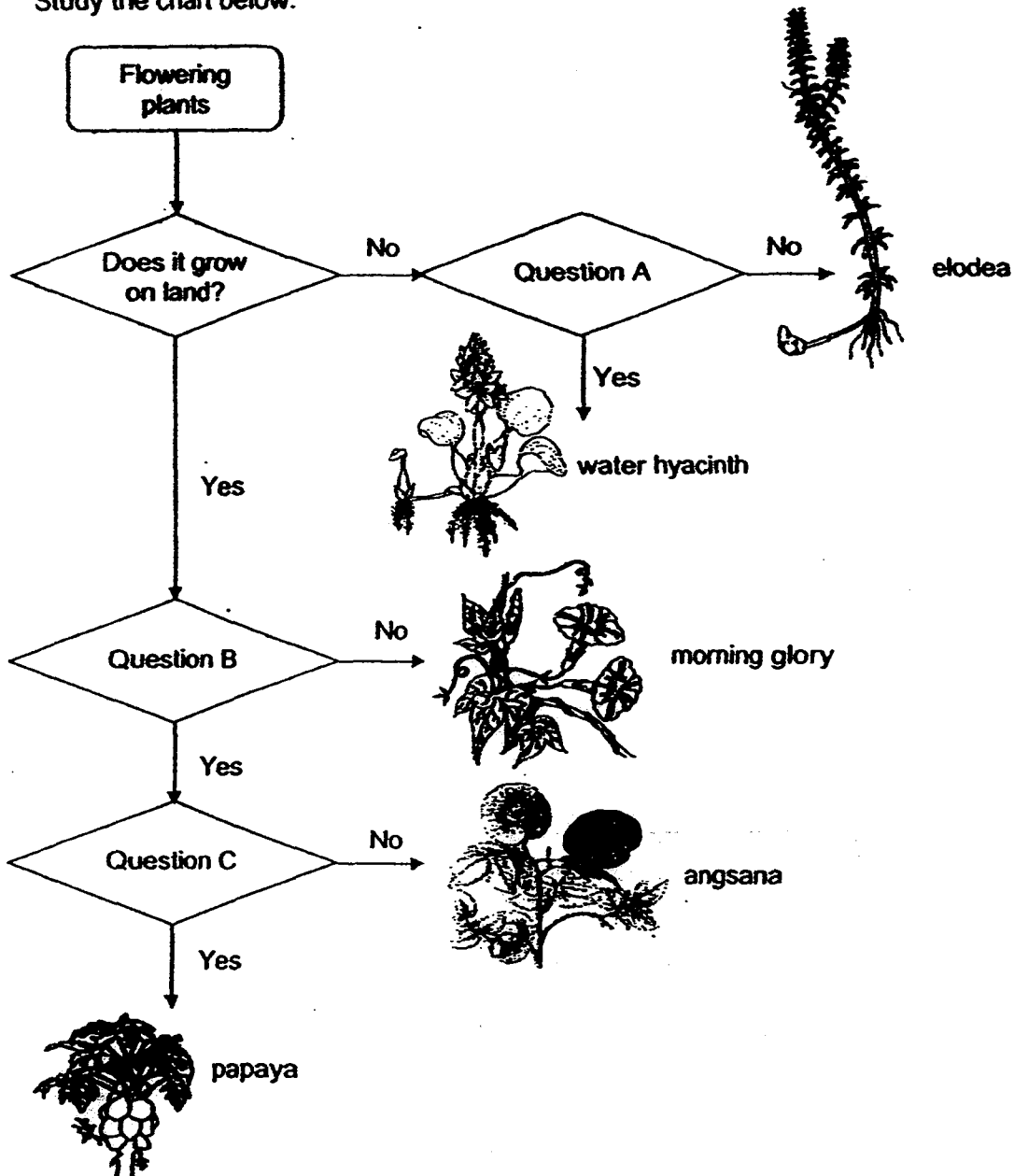

Which of the following correctly states what questions A, B and C are?

	Question A	Question B	Question C
(1)	Does it float on water?	Does it have a strong stem?	Are the fruits dispersed by wind?
(2)	Does it have swollen leaf stalks?	Does it have a weak stem?	Are the fruits dispersed by wind?
(3)	Does it float on water?	Does it have a strong stem?	Does it have fleshy fruits?
(4)	Does it have swollen leaf stalks?	Does it have a weak stem?	Does it have fleshy fruits?

2. The diagram below shows a flowering plant.

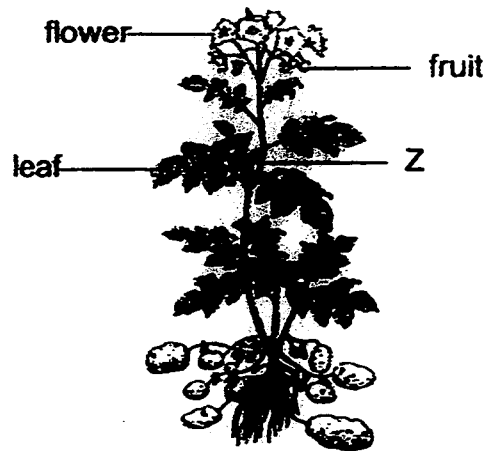

What are the directions in which water and food are being transported at Z?

Direction of transport of	
water	food
(1) upwards	downwards
(2) upwards	upwards and downwards
(3) downwards	upwards
(4) downwards	upwards and downwards

3. The diagram below shows how blood flows in certain parts of the human body a few hours after a meal.

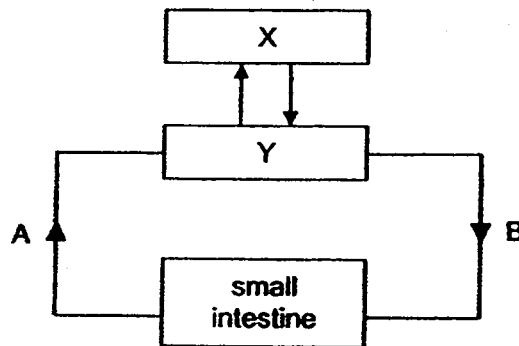

Which of the following below best describes the diagram above?

	Organ X	Organ Y	Blood at A as compared to blood at B
(1)	lungs	heart	contains more digested food and more carbon dioxide
(2)	lungs	heart	contains less digested food but more carbon dioxide
(3)	heart	lungs	contains less digested food and less carbon dioxide
(4)	heart	lungs	contains more digested food but less carbon dioxide

4. The diagram below shows the life cycle of the butterfly.

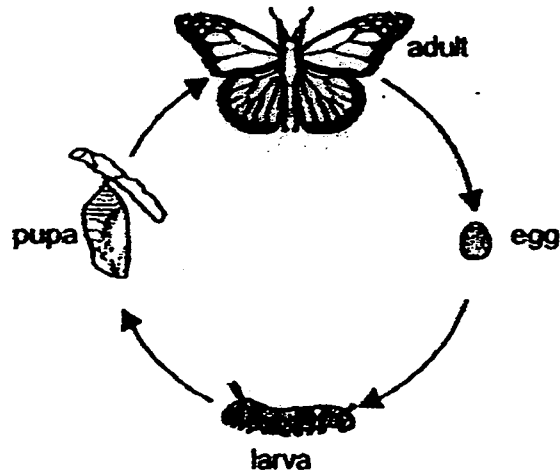

This butterfly is found at Ahmad's vegetable farm. Which stage of the life cycle of the butterfly is of a disadvantage to him?

- (1) egg
- (2) larva
- (3) pupa
- (4) adult

5. Study the diagram below.

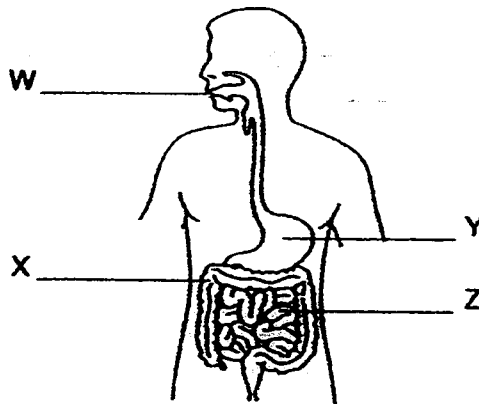

In which part of the digestive system is digested food absorbed into the bloodstream?

- (1) W
- (2) X
- (3) Y
- (4) Z

6. Two types of plants, X and Y, were planted on a piece of land as shown in the diagram below.

A few years later, more plants, X and Y were found on the piece of land.

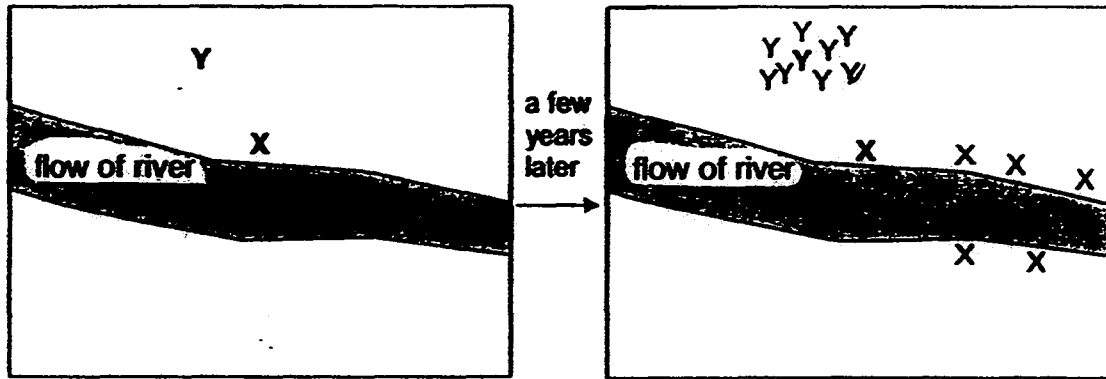

Which of the following correctly shows the characteristics of the fruits?

(1)

Fruit of plant	Characteristic
X	Small and light
Y	Fibrous husk

(2)

Fruit of plant	Characteristic
X	Fibrous husk
Y	Pod-like structure

(3)

Fruit of plant	Characteristic
X	Waterproof covering
Y	Hooks

(4)

Fruit of plant	Characteristic
X	Fleshy fruit
Y	Wing-like structure

7. The diagrams below show the human and plant reproductive parts.

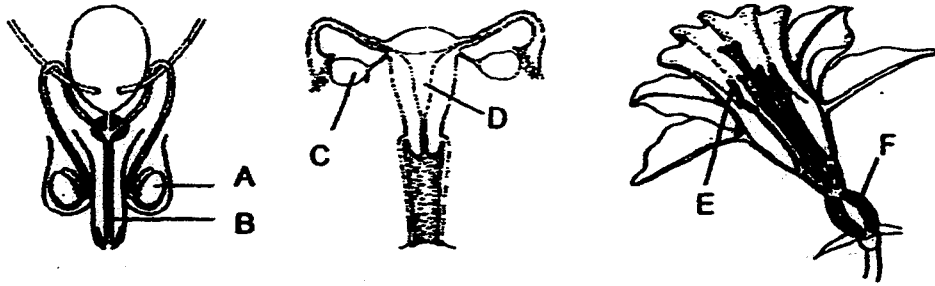

Which of the following shows where the male and female reproductive cells can be found?

	Male reproductive cell	Female reproductive cell
(1)	A, E	C, F
(2)	A, F	C, E
(3)	B, E	C, F
(4)	B, F	D, E

8. Study the three different cells shown below.

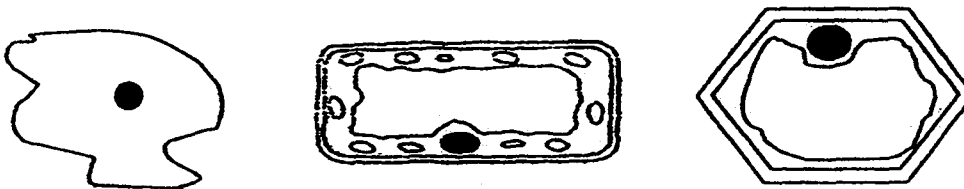

Which of the following statements is true about all the three cells?

- (1) They are animal cells.
- (2) They can photosynthesize.
- (3) They contain nucleus and cell wall.
- (4) They contain cytoplasm and cell membrane.

9. Mr Tan grows alternating rows of plants A and B, a distance away from each other, on a steep slope. The dead leaves of plants A and B fall onto the soil of the slope.

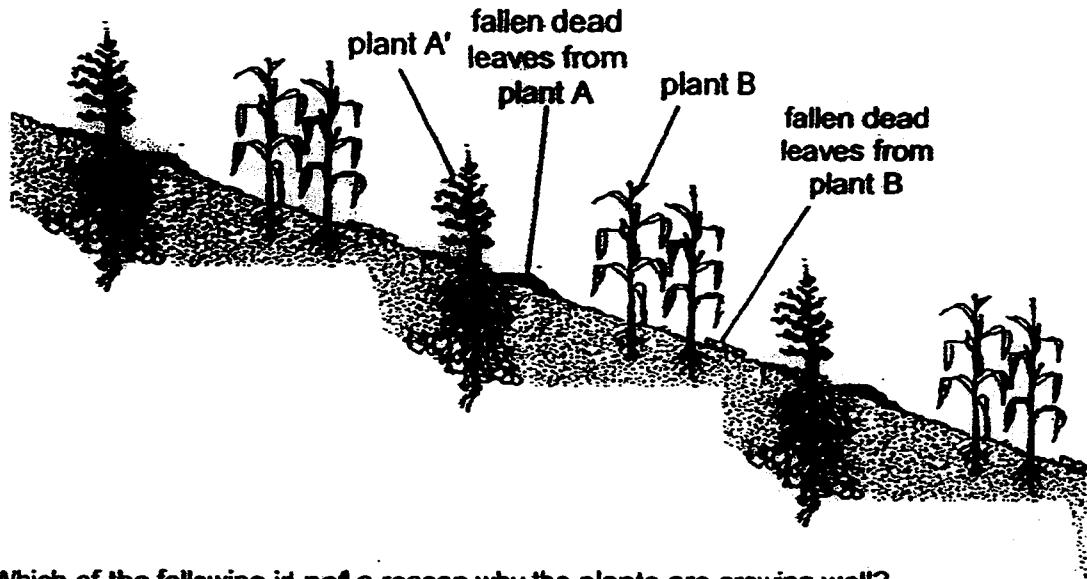

Which of the following is **not** a reason why the plants are growing well?

- (1) Soil erosion is prevented.
  - (2) Fertilisers are added to the soil.
  - (3) Rats are kept away from eating plant B.
  - (4) Overcrowding of plants A and B is reduced.
10. A farmer sprayed some fertiliser on his field. Soon afterwards, there was a heavy storm and some of the fertiliser was washed into a lake.

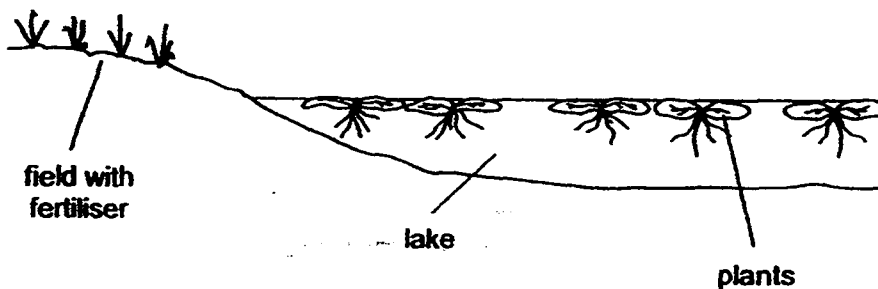

What is the effect of the fertiliser on the growth of the plants in the field and the plants in the lake?

	Plants in the field	Plants in the lake
(1)	increase	increase
(2)	decrease	increase
(3)	increase	decrease
(4)	decrease	decrease

11. Helen wants to find out whether carbon dioxide is needed for photosynthesis. She placed five set-ups A, B, C, D and E under sunlight for several hours.

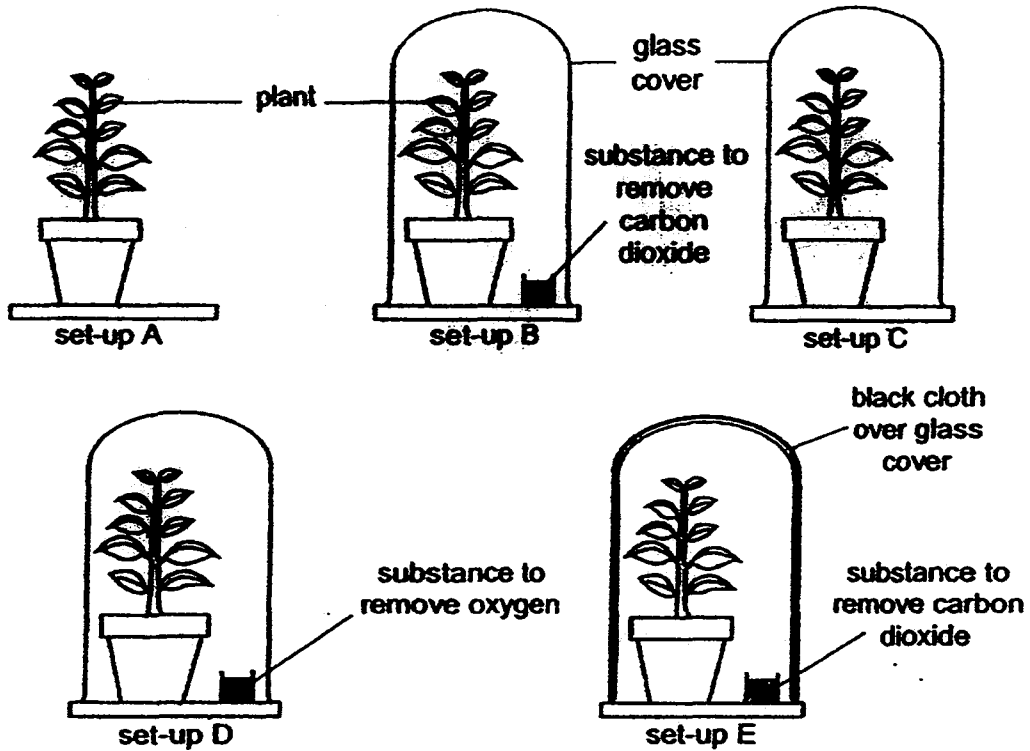

Which two set-ups should she select for her experiment?

- (1) A and D only
  - (2) B and C only
  - (3) B and E only
  - (4) C and D only
12. The following relationships were observed among four living things E, F, G and H.

E feeds on G.  
H feeds on E.  
G gets its food from F.  
H feeds on G but does not feed on F.

Which one of the following classifications is correct?

	producer	prey	prey and predator	predator
(1)	F	H	E	G
(2)	H	E	G	F
(3)	F	G	E	H
(4)	H	F	G	E



13. Study the food web below.

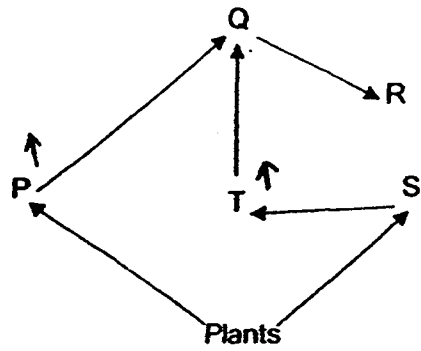

Which of the following graphs shows how the population of P, R, S and T are likely to be affected if a disease wiped out the population of Q?

- (1) Population size vs Time: P and T increase; S and R decrease.
- (2) Population size vs Time: T increases; R, P, and S decrease.
- (3) Population size vs Time: T and S increase; P and R decrease.
- (4) Population size vs Time: T and P increase; R and S decrease.

14. Xin Yi made three model flowers of the same size and shape using white-coloured cards. She put different amount of sweetened water in the centre of each flower. The model flowers were left in the open field as shown below.

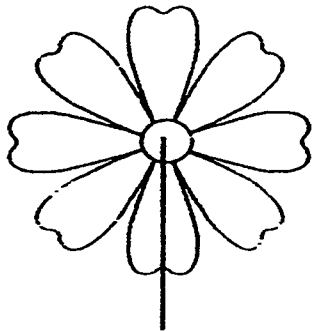

centre with 4 drops  
of sweetened water

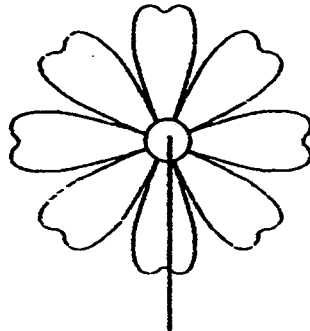

centre with 8 drops  
of sweetened water

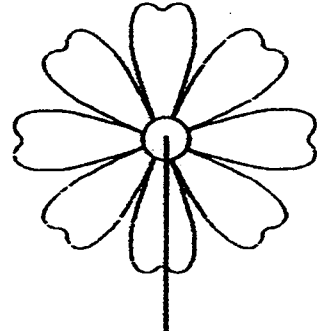

centre with 12 drops  
of sweetened water

She counted the number of butterflies that visited each model flower over three hours.

Now, Xin Yi wants to find out the colour of flowers which most butterflies prefer. What change(s) to the experiment should she make?

- A : She should use model flowers of different sizes.
  - B : She should use model flowers of different colours.
  - C : She should put equal amount of sweetened water on each model flower.
  - D : She should ensure that each model flower has the same number of butterflies visiting.
- (1) B only
- (2) B and C only
- (3) A and D only
- (4) B, C and D only

15. Marvin made two shapes, P and Q, with the same mass of clay.

He filled two identical containers with  $200\text{cm}^3$  of oil and dropped the shapes into the containers as shown below.

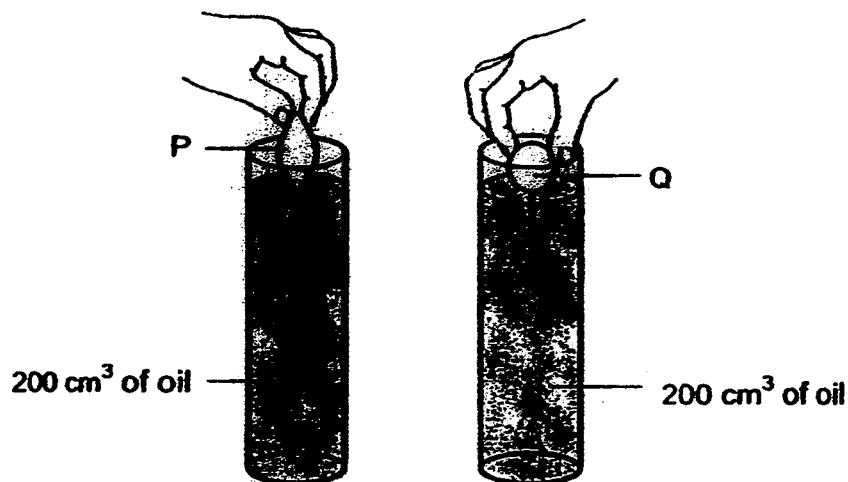

He then measured the time taken for shapes P and Q to travel from the surface of the water to the bottom of the container and observed that shape P took a shorter time to reach the bottom of the container.

Which of the following correctly explains his observation?

- (1) There was less water resistance acting on shape Q.
- (2) There was more water resistance acting on shape Q.
- (3) There was less gravitational force acting on shape Q.
- (4) There was more gravitational force acting on shape Q.

16. Devi trapped some gas in a container.

She pulled the piston towards the open end of the container as shown below.



How was the volume and mass of the gas affected by moving the piston?

	Volume of gas	Mass of gas
(1)	decreases	decreases
(2)	increases	increases
(3)	decreases	remains the same
(4)	increases	remains the same

17. Vicky conducted an experiment to study the hardness of four different materials S, T, U and V. She used the sharp ends of a plastic rod and a wooden rod to scratch each of these materials. She recorded her observations in the table below.

Rod used to scratch material	Scratch marks observed on materials?			
	S	T	U	V
wood	yes	no	yes	no
plastic	yes	yes	no	no

Which of the following statements is true?

- (1) S and T are harder than wood.
  - (2) T and U are harder than wood.
  - (3) U and V are harder than plastic.
  - (4) T and V are harder than plastic.
18. The diagram below shows two cups, P and Q, made of the same material.



Which of the following statements about cup P and cup Q is/are correct?

- A : Cup Q will keep hot water hot for a longer period of time than cup P.
- B : Cup P will keep cold water cold for a longer period of time than Cup Q.
- C : Cup P will allow cold water to reach the surrounding temperature in a shorter period of time than cup Q.
- (1) A only
  - (2) A and B only
  - (3) A and C only
  - (4) B and C only

19. Devi placed magnet A at a starting point and a paper clip at a distance away from the magnet, as shown below.

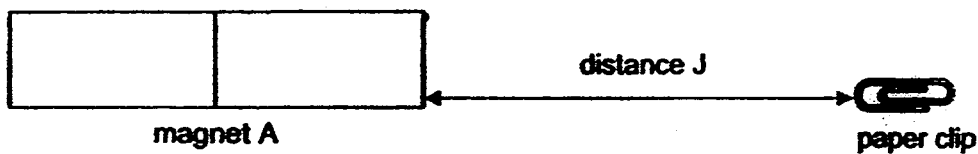

Devi moved the paper clip slowly towards magnet A. She recorded distance J, the greatest distance at which the magnet attracted the paper clip.

She repeated the experiment with three other magnets, B, C and D as shown below.

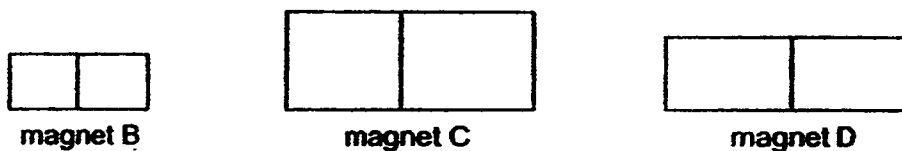

The table below shows the results of her experiment.

Magnet	A	B	C	D
Distance J (cm)	2	7	5	8

Based on the table, which of the following statements are true?

- A : Magnet D is stronger than magnet B.
  - B : Magnet A is the strongest amongst all the magnets.
  - C : The strength of the magnet is not affected by its size.
  - D : Only magnet C can attract paper clips that are placed 5 cm away.
- (1) A and C only  
(2) B and C only  
(3) B and D only  
(4) A, C and D only

20. The diagram below shows three sheets, P, Q and R, of the same size. Each sheet was made of a different material and has a shape cut out in the centre as shown below.

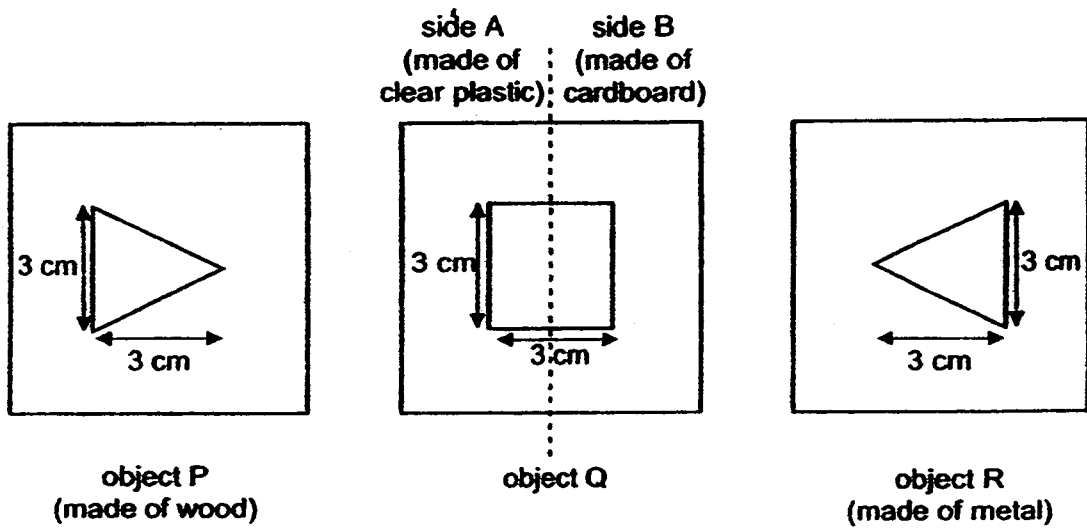

The sheets were then glued together and light was shone at it.



Which of the following shows the correct shadow formed on the screen?

(1)

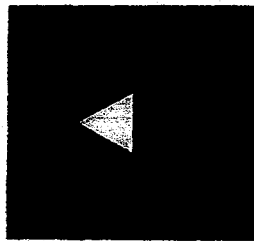

(2)

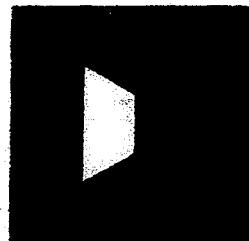

(3)

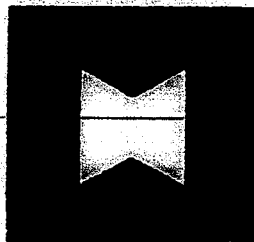

(4)

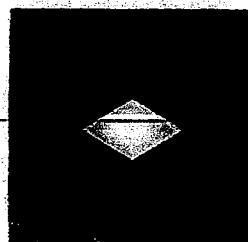

21. The table below shows the state of four substances, P, Q, R and S, at different temperatures.

Substance	State of substance at		
	30°C	50°C	70°C
P	solid	solid	liquid
Q	solid	liquid	gas
R	solid	solid	solid
S	liquid	liquid	gas

Which of the following statements is/are definitely true?

- A : Q boils at 70°C.
- B : P is a solid at 60°C.
- C : S has the lowest melting point.
- D : R has the highest melting point.

- (1) D only
- (2) A and B only
- (3) C and D only
- (4) A, B, C and D

22. Look at the picture below.



A wet towel is repeatedly placed on the baby's forehead.  
To bring down the fever, which of the following processes is taking place?

- (1) Boiling
- (2) Melting
- (3) Evaporation
- (4) ~~Condensation~~

23. Clara held a piece of paper with a metal coin over a candle flame.

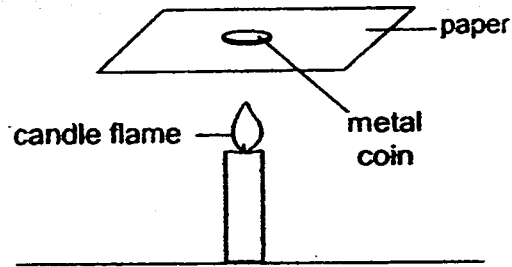

A few minutes later, she removed the paper from the flame. Which of the following diagrams show what was observed on the paper?

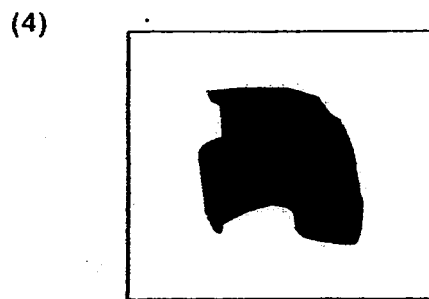
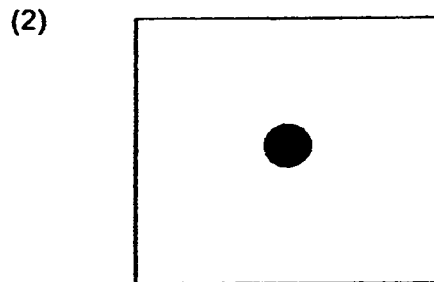
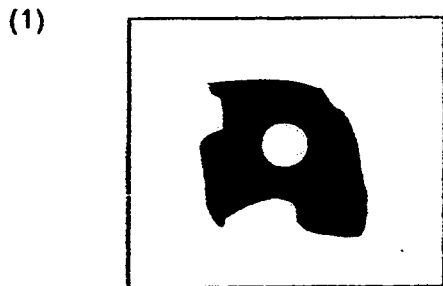

24. Study the table below on the different ways of water conservation.

A	B	C
<ul style="list-style-type: none"> <li>Using rainwater to wash the corridor</li> <li>Using water for rinsing rice to water plants.</li> </ul>	<ul style="list-style-type: none"> <li>Treating waste water to make it drinkable.</li> </ul>	<ul style="list-style-type: none"> <li>Turning off the tap while scrubbing the dishes.</li> <li>Washing dishes in a basin instead of using a running tap.</li> </ul>

What do A, B and C best represent?

	A	B	C
(1)	Reuse	Reduce	Recycle
(2)	Reduce	Reuse	Recycle
(3)	Recycle	Reduce	Reuse
(4)	Reuse	Recycle	Reduce



25. Ahmad set up an experiment as shown below. He placed a strong magnet at point Z and added oil to the surface of the ramp. He then released the copper block at point X. He observed that the copper block moved down the ramp and stopped at point Z where it touched the magnet.

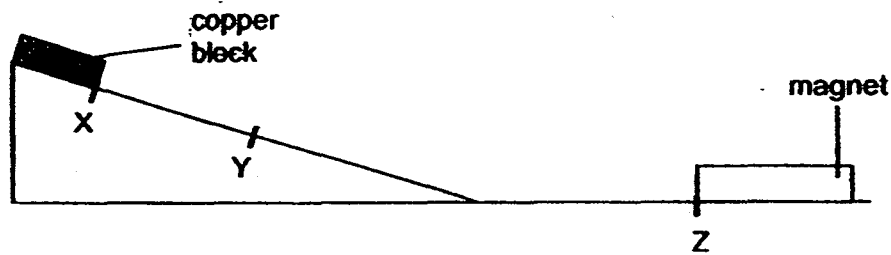

Which of the following statements on the experiment is/are true?

- A : There was magnetic force acting on the copper block at point Z.
- B : There was gravitational force acting on the copper block at point Z.
- C : There was no frictional force acting on the copper block when it was moving at point Y.

- (1) A only
- (2) B only
- (3) A and C only
- (4) A, B and C

26. A ball was released from a height above ground. It moved from P to Q as shown below.



Which of the following is correct?

	Potential energy of the ball from P to Q	Gravitational force acting on the ball from P to Q
(1)	decreases	remains the same
(2)	decreases	decreases
(3)	increases	increases
(4)	remains the same	remains the same

27. Thomas wants to find out if the thickness of the wires used in an electrical circuit affects the brightness of the bulbs. He constructed the following set-ups A, B, C and D.

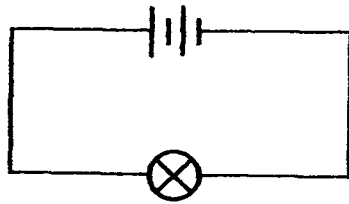

set-up A

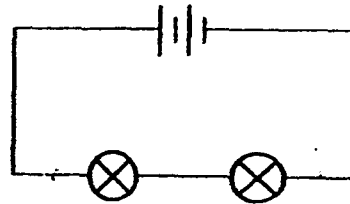

set-up B

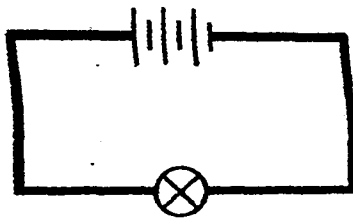

set-up C

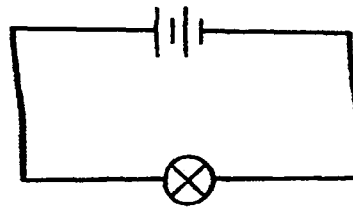

set-up D

Which set-ups should he select to conduct a fair test?

- (1) A and D only
- (2) A and C only
- (3) B and D only
- (4) A, C and D only

28. Study the diagram below.

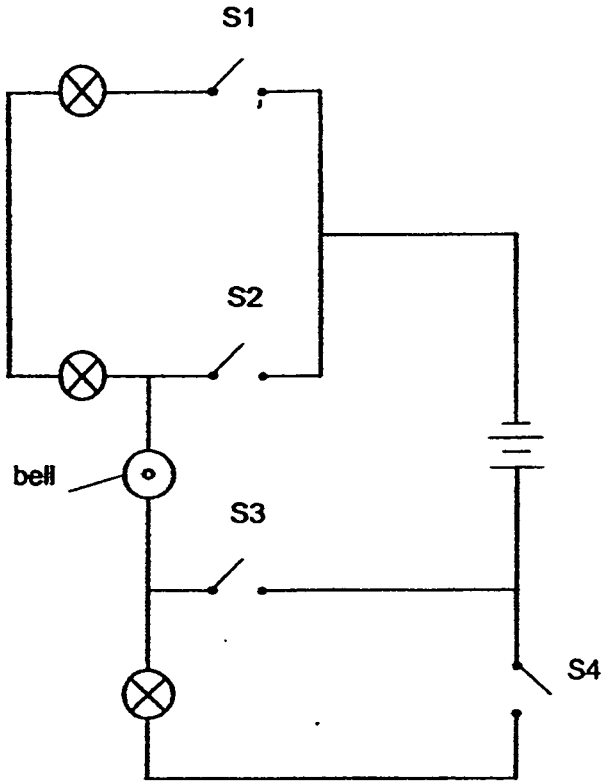

Which of the following will result in the bell ringing without lighting up any of the bulbs?

	S1	S2	S3	S4
(1)	closed	closed	closed	open
(2)	open	closed	open	closed
(3)	open	closed	closed	open
(4)	closed	open	open	closed

29. Hannah had three bars, X, Y and Z, each made of different materials. She placed them at positions P, Q and R, as shown in the circuit below and recorded the results.

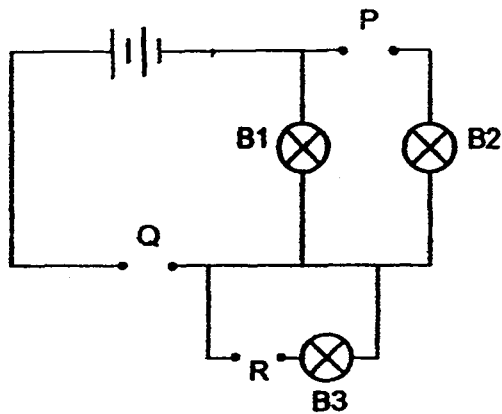

The results of the experiment were shown in the table below.

Position	Bar
P	X
Q	Y
R	Z

Bulb	Did the bulb light up?
B1	yes
B2	no
B3	yes

She then repeated the experiment by placing the bars at different positions as shown in the table below.

Position	Bar
P	Y
Q	Z
R	X

Which of the following correctly shows the bulb(s) that will light up?

	B1	B2	B3
(1)	no	yes	yes
(2)	yes	yes	no
(3)	yes	no	yes
(4)	no	no	no

30. Tom sat on a swing and moved to and fro through a height as shown in the diagram below.

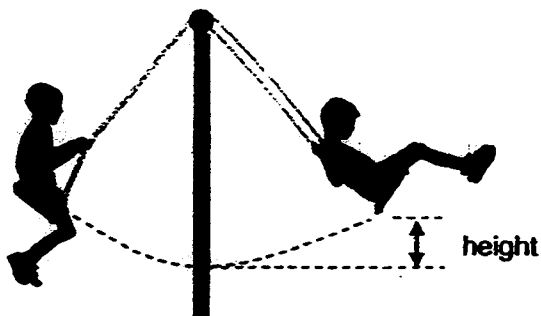

Which of the following graphs correctly shows how the potential energy and kinetic energy of the swing change with the height?

(1)

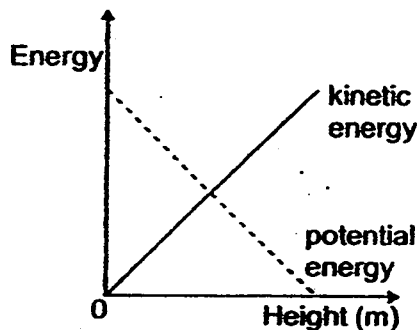

(2)

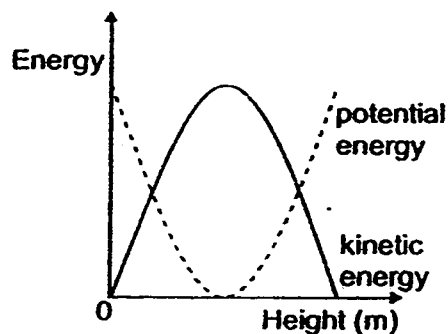

(3)

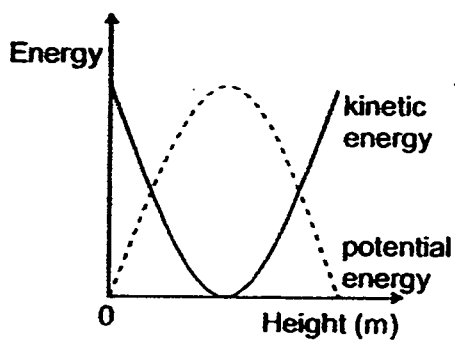

(4)

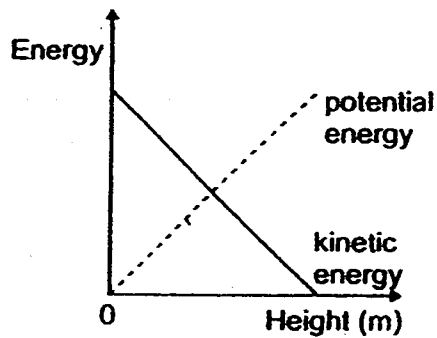

End of Section A

**PEI CHUN PUBLIC SCHOOL**  
**PRELIMINARY EXAMINATION, 2016**

**SCIENCE**  
**SECTION B**

Time: 1 h 45 min

Name: \_\_\_\_\_

Class : Primary 6 \_\_\_\_\_

Date : 5 August 2016

Parent's Signature: \_\_\_\_\_

<b>SECTION A</b>	<b>60</b>
<b>SECTION B</b>	<b>40</b>
<b>TOTAL</b>	<b>100</b>

**INSTRUCTIONS TO CANDIDATES**

**DO NOT OPEN THIS BOOKLET UNTIL YOU ARE TOLD TO DO SO.**

**FOLLOW ALL INSTRUCTIONS CAREFULLY.**

**ANSWER ALL QUESTIONS.**

**WRITE YOUR ANSWERS IN THIS BOOKLET.**

**Section B (40 marks)**

For questions 31 to 44, write your answers in the spaces provided.

31. The diagram below shows the different stages of growth of a bean plant.

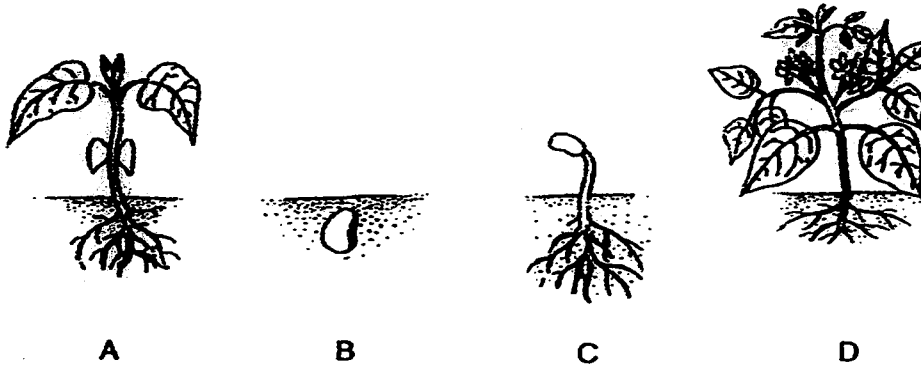

a) Arrange the above stages, A, B, C and D, in the correct order. [1]

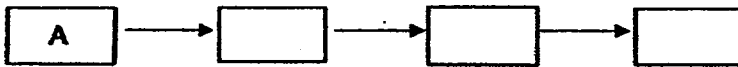

b) At which stages will the plant be able to make food? Give a reason for your answer. [1]

---

---

After some time, some of the leaves of the plant wilted and fell onto the ground.

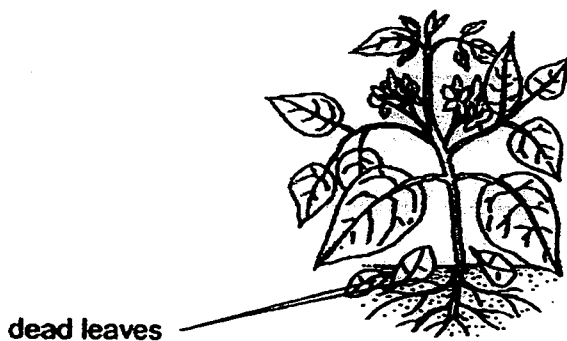

c) Explain how the dead leaves will benefit the plant. [1]

---

---

32. Vimal conducted an experiment to find out how the presence of living things affects the level of carbon dioxide in the water. He placed four test tubes, D, E, F and G, beside the window on a sunny day for 6 hours.

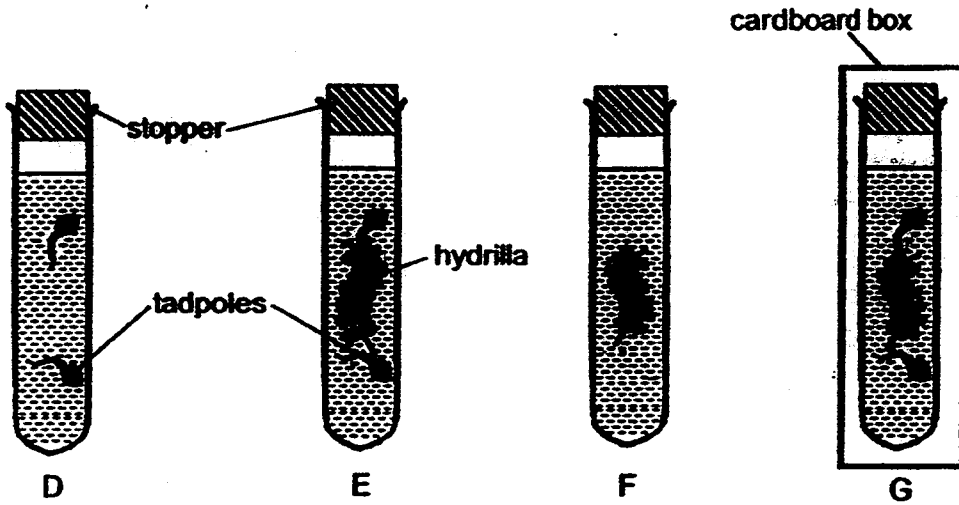

- a) Arrange test tubes D, E, F and G according to the amount of carbon dioxide in the water at the end of the experiment, starting from the least. [ 1 ]

Least <span style="float: right;">→</span> Most			

- b) Vimal continued the experiment for a week and observed that the tadpoles in test tube E survived longer than the tadpoles in test tube D.

Explain why.

[ 2 ]

---



---



---



33. Tom conducted an experiment to find out if soil contains air.

First, he placed a thin plastic sheet on a glass completely filled with water and inverted the glass.

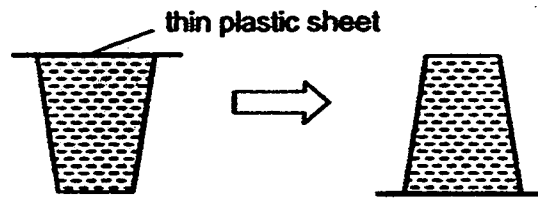

He then placed the inverted glass on top of a cup of soil. When he removed the sheet, he observed that the water level dropped and bubbles appeared in the water.

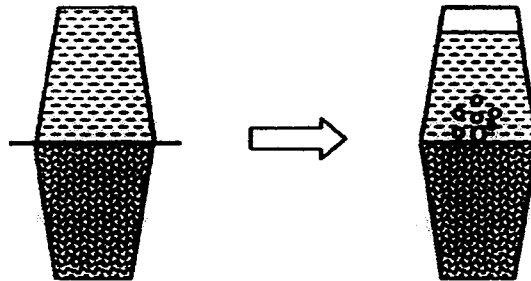

a) Explain his observation.

[ 1 ]

---

---

---

Tom conducted a second experiment as shown below.

He placed 50 cm<sup>3</sup> of soil A into a funnel and poured 100 cm<sup>3</sup> of water into it. He then measured the amount of water collected in the beaker after 10 minutes.

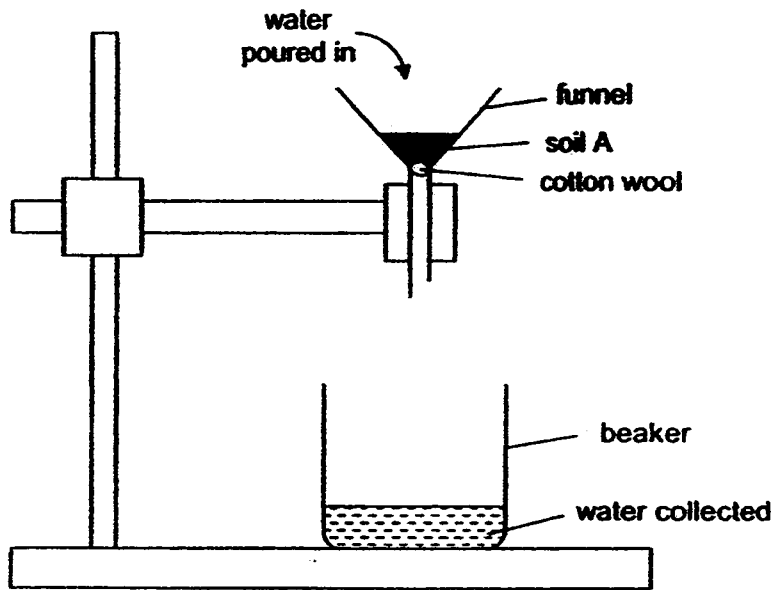

He repeated his experiment with soil B and C and recorded his results in the table below.

	Soil A	Soil B	Soil C
Volume of water poured in (cm <sup>3</sup> )	100	100	100
Volume of water collected (cm <sup>3</sup> )	80	25	95

- b) In a rice plantation, a flooded paddy field is needed for the seedlings to grow. Which soil sample, A, B or C, is the most suitable for use in the paddy field? Give a reason for your answer.

[ 1 ]

---

---

- c) Give a reason why Tom put some cotton wool in the funnel.

[ 1 ]

---

---

34. The diagram below shows a food web in a farm. A farmer grows rice on his farm to feed his family.

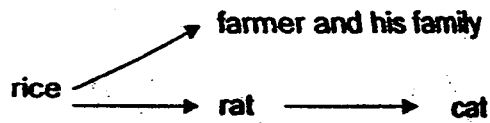

Recently, he observed a decrease in the amount of rice grains he could collect. The rice plants were healthy and produced the same amount of rice grains as in previous years.

Using the information from the food web, answer the questions below.

- a) What is a possible cause for the decrease in the rice grains collected? [ 1 ]

---

---

- b) How can the farmer prevent the decrease in the rice grains collected? Explain why. [ 2 ]

---

---

---

35. Crab E is a small crab with a pair of small claws. It feeds on small fishes and carries a pair of organism F in its claws as shown below.



Crab E waves organism F around when threatened. The tentacles of the organism F can sting and paralyse small fishes.

- a) Suggest two advantages of carrying organism F in its claws. [ 2 ]

---



---



---



---

Crab G has a shell that is covered with hooks to attach algae, seaweed or anything they can find on the seabed. Crab G lives on the seabed and the seabed is covered with seaweed.



Once a suitable covering is found, crab G snips it off with its claws and attaches it on the shell. The crab continues the process until it is sufficiently covered. The algae or seaweed continue to grow once attached.

- b) State one benefit for crab G to cover itself with the seaweed [ 1 ]

---



---



---

SCORE	
-------	--

36. John wanted to find out how the animal waste disposed of by a farm affected the survival of the three aquatic organisms A, B and C.

He prepared eight beakers, each containing 1000 ml of clean river water and the same number of organisms A, B and C. He added different amounts of waste released by the farm to each of the beakers. After a day, he counted the number of each type of organism still alive in the beakers. The graph below shows his result.

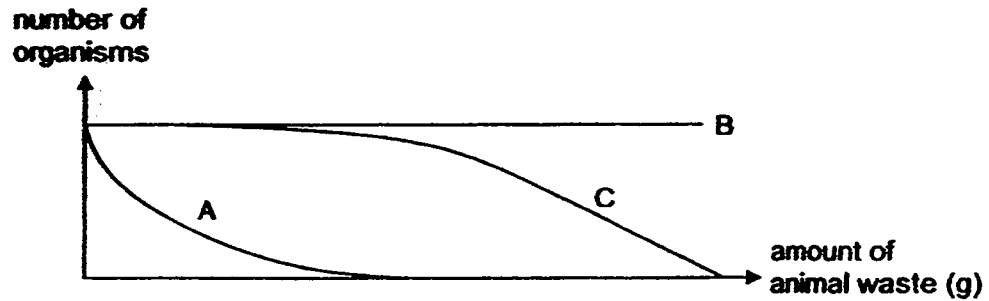

- a) Which organism(s) was/were affected by the animal waste? [ 1 ]

Farms P and Q released animal waste into a river. The directions of the river are indicated by the arrows as shown in the map below.

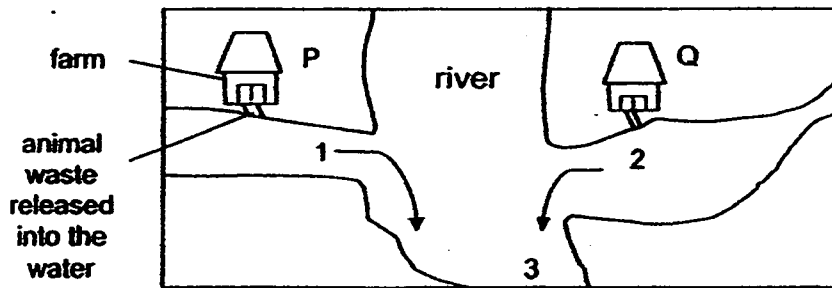

John took water samples from three points of the river as numbered in the map. The number of aquatic organisms A, B and C in each water sample is recorded below.

	1	2	3
A	few	none	none
B	many	many	many
C	many	few	none

- b) Which farm, P, Q or R, gave out waste that was most harmful to the aquatic organisms in the experiment? Give a reason for your answer. [ 1 ]

- c) Explain why the amount of animal waste would cause a decrease in the number of fish living in the river. [ 1 ]

SCORE	
-------	--

37. Jun Wen conducted an experiment as shown below. He covered the opening of an empty bottle with a stopper and heated it.

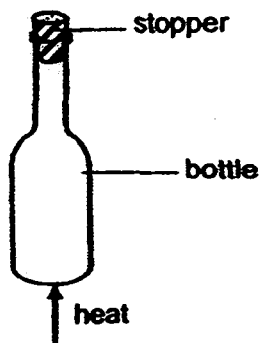

- a) After some time, the stopper flew off. Explain his observation.

[ 1 ]

---

---

Jun Wen then made a hole in the bottle and repeated his experiment.

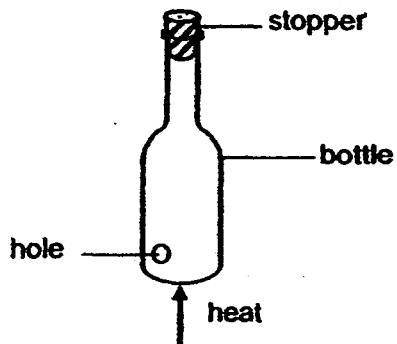

- b) He observed that the stopper did not fly off this time. Explain his observation.

[ 1 ]

---

---

38. Su Mei heated 300 ml of liquid W in a beaker for some time till point X.

Liquid W

She measured the temperature of the water at regular intervals. Her results are shown in the graph below.

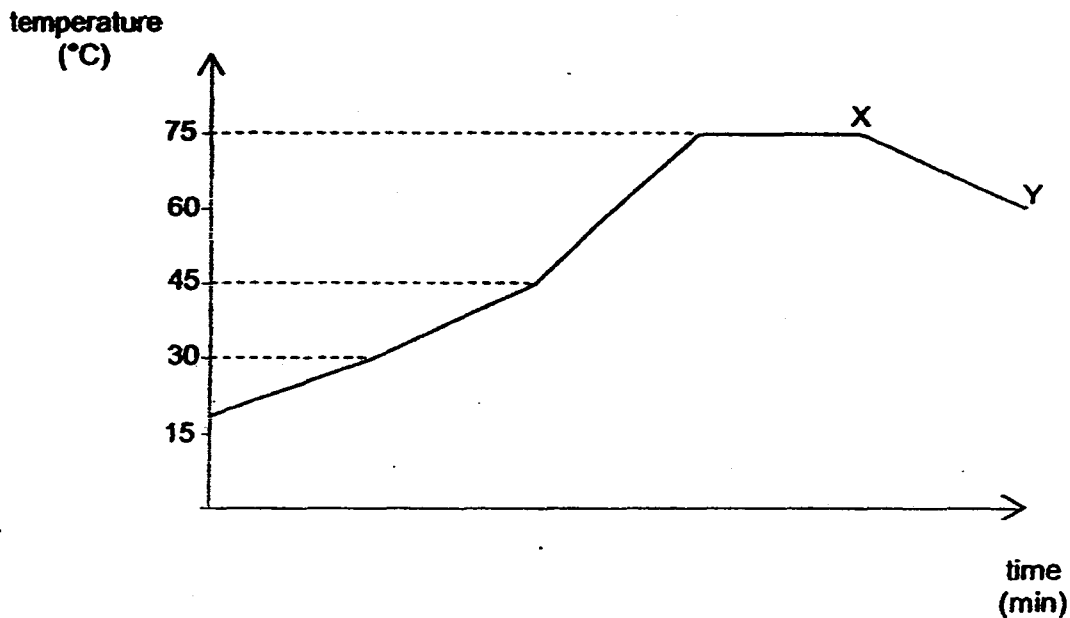

a) What is the boiling point of liquid W? [ 1 ]

---

---

b) Su Mei measured the volume of liquid W at point Y. She discovered that the volume of the liquid W had decreased to 295 ml.

Give a reason for the decrease in the volume of liquid W at point Y. [ 1 ]

---

---

c) Su Mei repeated the experiment using 100 ml of liquid W.

Will the boiling point of liquid W increase, decrease or remain the same?

Give a reason for your answer.

[ 1 ]

---

---

39. The diagram below shows an electrical system for a lamp. The system has a circuit breaker which will switch off the circuit when too much current flows through it. This prevents the bulb in the lamp from fusing.

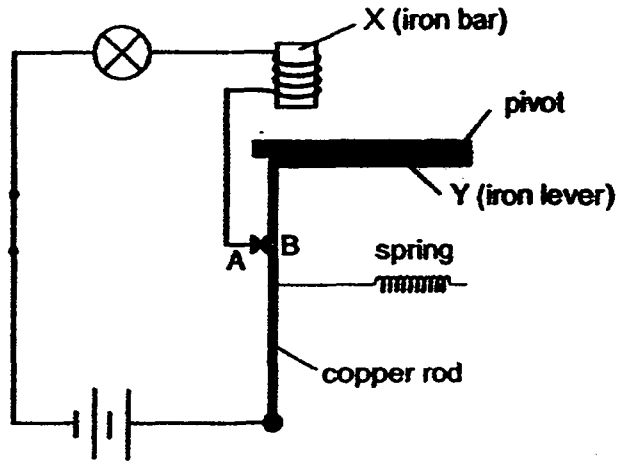

The diagram below shows what happened to the system when she increased the number of batteries.

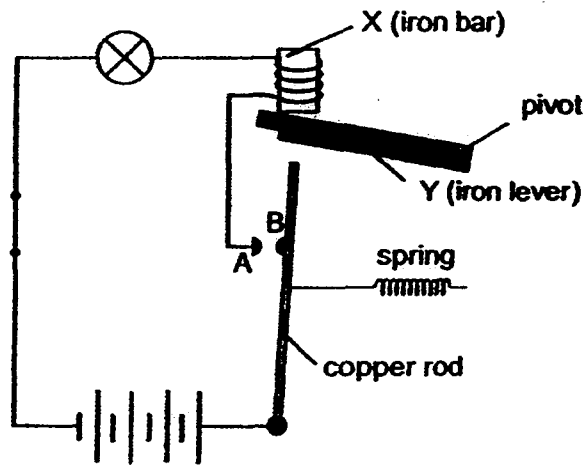

Explain how the circuit breaker prevents too much current from flowing through the bulb in the lamp. [2]

---



---



---



---



---



40. Emily set up an experiment as shown below.

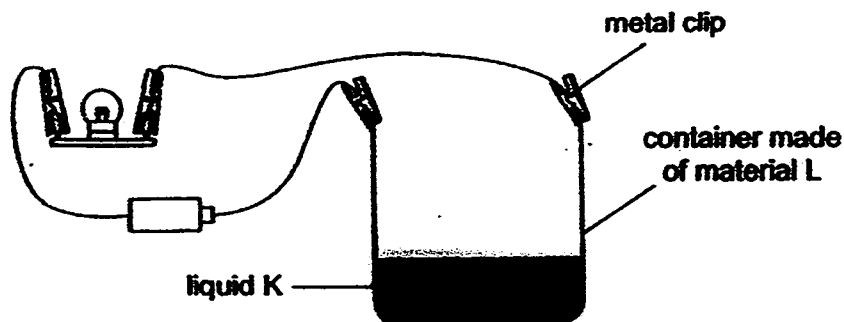

When the metal clips were connected to the container, the bulb lit up.

- a) Emily said that liquid K is a conductor of electricity.  
Do you agree? Give a reason for your answer.

[ 1 ]

---

---

- b) Emily repeated the experiment with a container made of material P.

State one observation to conclude that material P is a better conductor of electricity than material L.

[ 1 ]

---

---

41. In an experiment, an inflated balloon was glued to a toy car as shown below.

At A, in the diagram below, air was released from the balloon which caused the car to move forward. At B, all the air had escaped but the car continued to move forward. The car came to a stop at ~~M~~<sub>C</sub>.

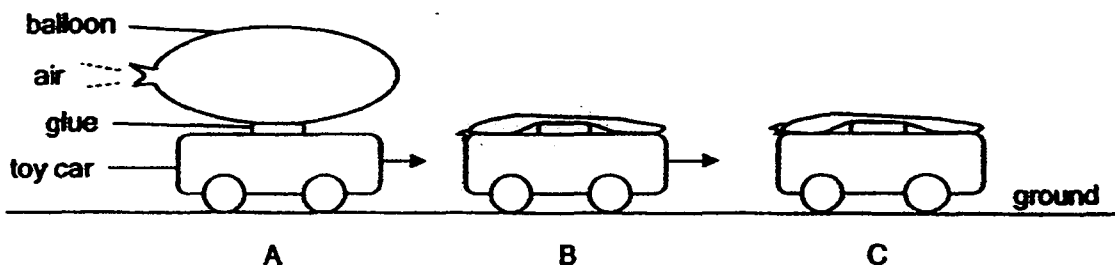

a) What was the source of energy that caused the car to move at the beginning of A? [ 1 ]

---

---

b) Give a reason why the car continued to move forward from B to C. [ 1 ]

---

---

c) Using only the materials given in the experiment, suggest one way to make the car move a longer distance in the experiment. [ 1 ]

---

---

42. Hui Peng conducted an experiment to find out if the colour of a container affects the amount of heat gained by it.

She used two identical air-tight containers, A and B, as shown below. Container A had a black surface while Container B had a white surface. She placed the containers under the sun. At first, the thermometers showed the same reading.

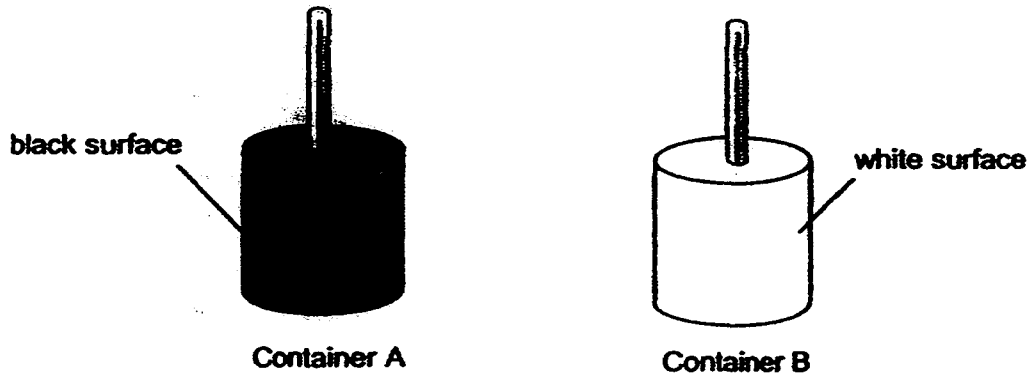

After a few hours, she observed that the temperature in Container A was higher than that of Container B.

- a) What could Hui Peng conclude from this experiment?

[ 1 ]

---

---

(question continues on next page)

Set-up 1 and set-up 2 show how water is obtained from seawater using the Sun's energy. Seawater flows through the set-ups at the same rate.

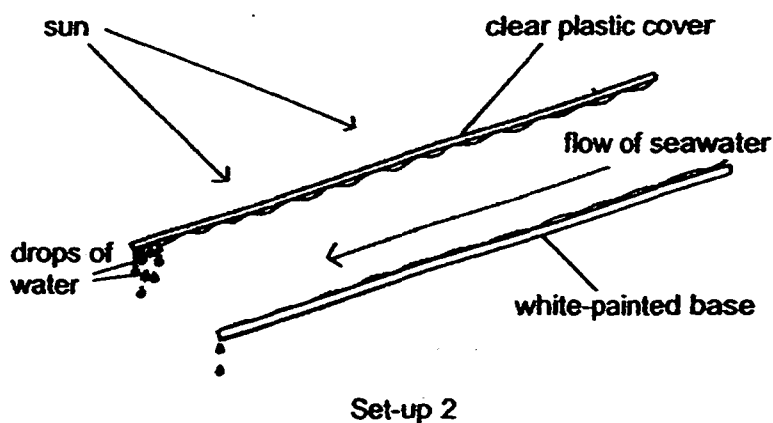
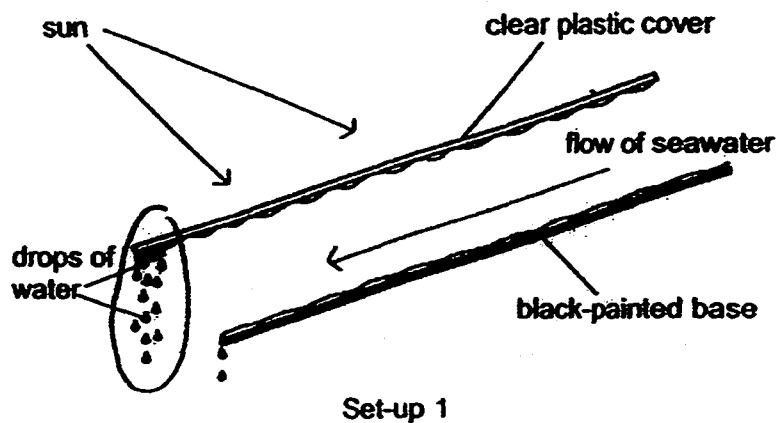

- b) It was observed that more water was collected in Set-up 1 than Set-up 2 at the end of the experiment. Explain why. [ 2 ]

---

---

---

---

- c) State what causes the water to flow down the plastic cover. [ 1 ]

---

---

43. John played with the toy shown below.

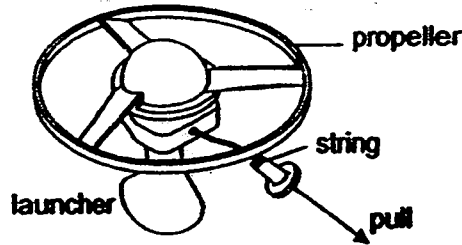

When he pulled the string very quickly, the propeller rotated and broke free from the launcher. The rotation of the propeller caused an upward force which helped it fly up. When it flew up to point B, it stopped rotating and dropped to the ground.

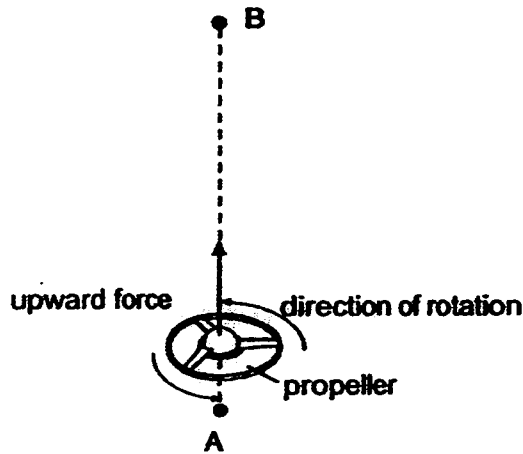

a) Give a reason why the propeller dropped to the ground after it had stopped rotating at point B. [ 1 ]

---



---

b) Fill in the boxes to show the energy changes that had taken place which caused the propeller to fly from point A to point B. [ 1 ]

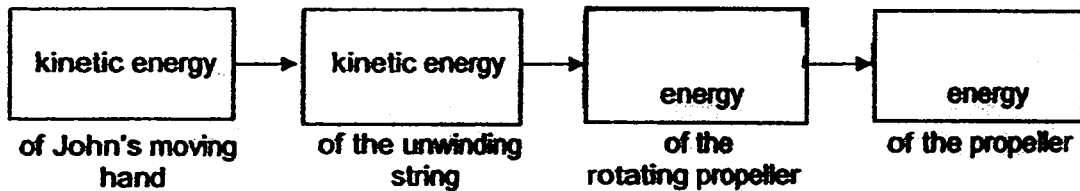

c) If John pulled the string slowly, would the propeller fly to a greater or lower height? Give a reason for your answer. [ 1 ]

---



---



---

44. Jenny conducted an experiment using the set-up shown below.

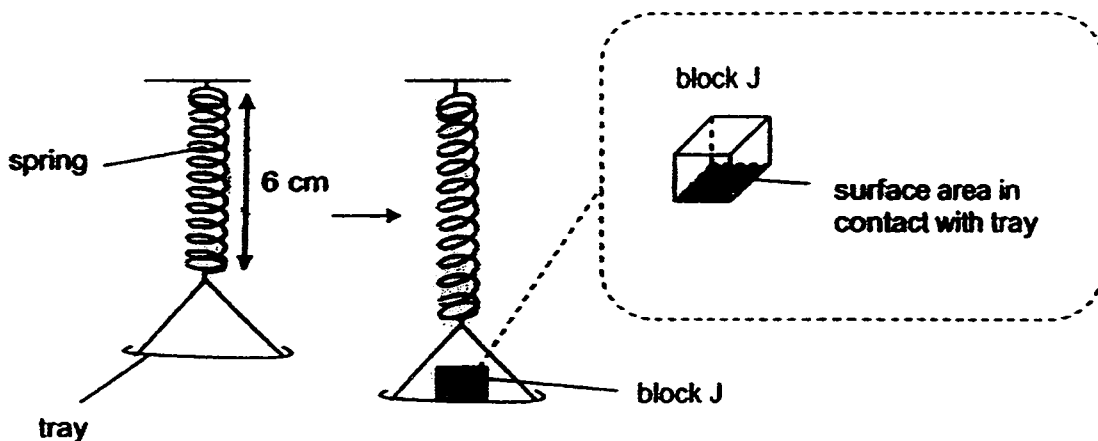

She measured the extension of the spring after block J was placed on the tray. She repeated the experiment using block K, L and M, each with various masses and surface areas. The results are shown below.

Block	Mass (g)	Surface area in contact with tray (cm <sup>2</sup> )	Extension of spring (cm)
J	100	27	2
K	150	27	3
L	200	8	4
M	200	27	4

a) What is the length of the spring when block J was placed on the tray? [ 1 ]

---

b) State how the extension of spring is affected by the mass of the block? [ 1 ]

---



---

c) Based on the results, Jenny concluded that the surface area of the block does not affect the amount of force acting on the spring.

Give a reason for her conclusion. [ 1 ]

---



---

Set by :  
Vetted by:

Mr David Koh, Mr Benjamin Kua, Mrs Sangeetha Narvin, Ms Pow Chen Yang  
P6 Science teachers

**PRELIMINARY EXAM PAPER 2016**

**SCHOOL : PEI CHUN PRIMARY SCHOOL**  
**SUBJECT : SCIENCE**  
**TERM : PRELIMINARY EXAMINATION 2016**

<b>Q1</b>	<b>Q2</b>	<b>Q3</b>	<b>Q4</b>	<b>Q5</b>	<b>Q6</b>	<b>Q7</b>	<b>Q8</b>	<b>Q9</b>	<b>Q10</b>
3	2	1	2	4	2	1	4	3	1
<b>Q11</b>	<b>Q12</b>	<b>Q13</b>	<b>Q14</b>	<b>Q15</b>	<b>Q16</b>	<b>Q17</b>	<b>Q18</b>	<b>Q19</b>	<b>Q20</b>
2	3	1	2	2	4	3	3	1	4
<b>Q21</b>	<b>Q22</b>	<b>Q23</b>	<b>Q24</b>	<b>Q25</b>	<b>Q26</b>	<b>Q27</b>	<b>Q28</b>	<b>Q29</b>	<b>Q30</b>
3	3	1	4	2	1	1	3	2	4

**Q31a.** D--- B--- C

**Q31b.** Stages A & D. At stages A & D, the bean plant has its leaves and it would be able to use carbon dioxide, water and sunlight to do photosynthesis to make food for the plant.

**Q31c.** The dead leaves decompose and act as fertilizer for the plant.

**Q32a.** F E D G

**Q32b.** Hydrilla in E can. Make food and produce oxygen for the tadpoles to respire but not test tube D.

**Q33a.** There were air spaces between the soil. Therefore, the water had to occupy the air space between the soil occupied by the air. Hence, bubbles appeared in the water. / Water enters the soil, occupies the air spaces in between the soil. Air in the soil will then be pushed out of the soil.

**Q33b.** Soil B. The volume of water collected was the least so the soil returns the most water.

**Q33c.** Tom put some cotton wool to prevent the soil from being collected in the beaker.

**Q34a.** There were more rats. Therefore, more rats would eat on more rice.

**Q34b.** Increase the number of cats. The cats feed on the rats. Therefore, more cats would feed on more rats and there would be lesser rats to eat the rice.

**Q35a.** Crab E use organism F to sting and paralyse small fishes to catch the prey ore easily. Carb E wave organism F to scare away its predators.

**Q35b.** G would be able to camouflage with the seabed and it would not be easily spotted by the prey and predator.

**Q36a.** A, C

**Q36b.** Q. At point Z, there was less organism A and less organism C as compared.

**Q36c.** As there was more animal waste, the water become more murky. Therefore, the submerged plant were not able to receive sunlight to do photosynthesis to make food for the plant and produce oxygen. Hence, the animals in the river would die due to lack of oxygen.

**Q37a.** The air in the bottle gained heat from the heat and expanded, forcing the stopper out. Therefore, the stopper flew off.

**Q37b.** As the air gained heat from the heat and expanded, thé air was able to escape through the hole. Therefore, the expanding air would not force the stopper out and the stopper would not fly out.

**Q38a.** 75°C

**Q38b.** Liquid W expanded and formed vapour.

**Q38c.** Remain the same. The boiling point of a liquid is not affected by the amount of liquid.

**Q39.** When there was too much current flowing through, X would become a strong electromagnet and can attract iron lever and the copper rod would move away. Therefore, A and B were not in contact with each other and the circuit would become an open circuit and electricity cannot flow through.

**Q40a.** No. Material C was a conductor of electricity while liquid K might be insulator. However, the circuit was still a close circuit and electricity can flow through, causing the bulb to light up.



**Q40b.** The bulb had to be brighter.

**Q41a.** The moving air in the balloon.

**Q41b.** There was still kinetic energy of the toy car. Therefore, the car moved forward from B to C.

**Q41c.** Increase the amount of air in the balloon at the start of the experiment.

**Q42a.** The black surface gains more heat than white surface.

**Q42b.** As black was a better conductor of heat, the black base gained more heat. The seawater evaporated faster to form water vapour. The water vapour lost heat and condensed on the plastic cover.

**Q42c.** Gravitational force.

**Q43a.** When the propeller stopped rotating, there was no kinetic energy of the rotating propeller as the kinetic energy had been converted to gravitational potential energy due to gravity.

**Q43b.** 1. Kinetic energy of the rotating propeller

2. Gravitational potential energy of the propeller.

**Q43c.** Lower. It would have less kinetic energy.

**Q44a.** 8 cm.

**Q44b.** As the mass of the block increases, the extension of the spring increases.

**Q44c.** Blocks L and M have the same mass but different surface area but the extension of the spring is the same.