

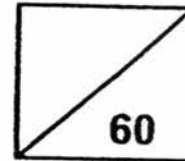

Rosyth School
Preliminary Examination 2016
STANDARD SCIENCE
Primary 6

Total
Marks:



Name: _____

Class: Pr 6 _____ Register No. _____ Duration: 1 h 45 min

Date: 25 August 2016 Parent's Signature: _____

Booklet A

Instructions to Pupils:

1. Do not open the booklets until you are told to do so.
2. Follow all instructions carefully.
3. This paper consists of 2 booklets - Booklet A and Booklet B
4. For questions 1 to 30 in Booklet A, shade the correct ovals on the Optical Answer Sheet (OAS) provided using a 2B pencil.
5. For questions 31 to 44, give your answers in the spaces given in the Booklet B.

* This booklet consists of 20 printed pages (including cover page).



Part I

For each question from 1 to 30, four options are given. One of them is the correct answer. Make your choice (1, 2, 3 or 4). **Shade the correct oval (1, 2, 3 or 4) on the Optical Answer Sheet.** (60 Marks)

1 Which of the following is/are the unit of life for all living things?

- A : cell.
- B : tissue
- C : organ

- (1) A only
- (2) B only
- (3) A and B only
- (4) A, B and C

2 Study the characteristics of P, Q, R and S below.

Characteristics				
	Can it move from place to place?	Can it reproduce?	Can it produce its own food?	Can it respond to changes?
P	No	No	No	Yes
Q	Yes	No	No	Yes
R	No	Yes	Yes	Yes
S	Yes	Yes	No	Yes

Which of them is/are definitely living thing(s)?

- (1) R only
- (2) Q and S only
- (3) R and S only
- (4) P, Q, R and S

3 Study the diagram below.

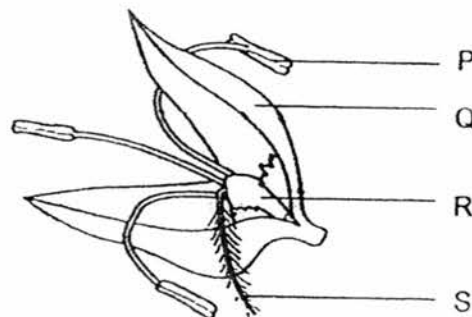

Which part(s) of the above flower is/are definitely not needed for pollination and fertilisation to take place?

- (1) P only
- (2) Q only
- (3) Q and R only
- (4) R and S only

- 4 The diagram below shows the 4 stages in the life cycle of an organism.

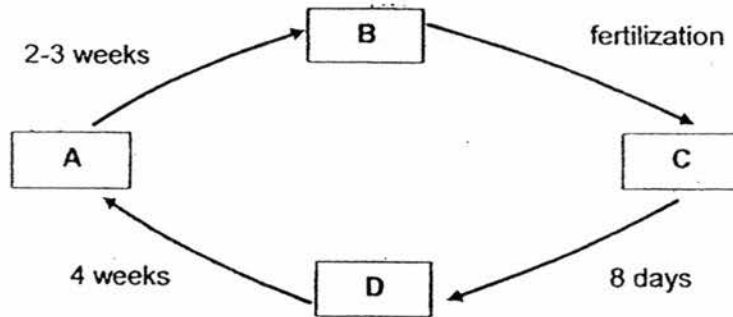

Identify the correct stages in the above life cycle.

	A	B	C	D
(1)	egg	larva	pupa	adult
(2)	pupa	adult	egg	larva
(3)	larva	pupa	adult	egg
(4)	adult	egg	larva	pupa

- 5 Which of the following body systems work together with the reproductive system in humans for the growth and birth of the baby?

A : Skeletal system
 B : Muscular system
 C : Digestive system
 D : Circulatory system
 E : Respiratory system

- (1) A, B and D only (2) C, D and E only
 (3) A, B, D and E only (4) A, B, C, D and E

- 6 Which of the following are similarities between digestion and decomposition?

A : Both provide nutrients for survival.
 B : Both require bacteria and fungi to take place.
 C : Both break matter down into simpler substances.
 D : Both break dead matter up into smaller substances.

- (1) A and C only (2) B and D only
 (3) A, B and D only (4) B, C and D only

- 7 Alison filled bag A with starch solution and immersed it into the iodine solution as shown below.

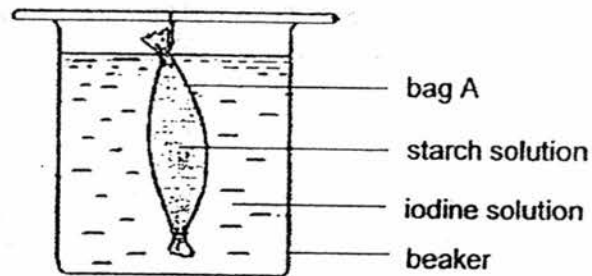

When the iodine solution comes into contact with starch, the iodine solution would change from brown to dark blue.

After one day, she observed that the content in bag A turned dark blue while the content in the beaker remained brown.

Which part(s) of a cell is/are similar in function to bag A?

- A : cell wall
 B : cell membrane
 C : cytoplasm

- (1) A only
 (2) B only
 (3) A and B only
 (4) B and C only
- 8 Ahmad studied a small habitat and constructed a food web which consisted of four organisms A, B, C and D. He described the food relationship as shown in the box below.

A eats B,C and D
B is eaten by A and D
D is eaten by C

Which organism in the food web above obtains its energy directly from the Sun?

- (1) A
 (2) B
 (3) C
 (4) D

- 9 The diagram below shows how blood flows from one organ to another through blood vessels A, B, C and D in a human body.

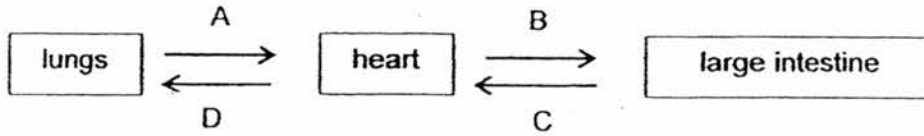

Blood samples, W, X, Y and Z were collected from the blood vessels shown above. The graph below shows the amount of digested food present in each blood sample.

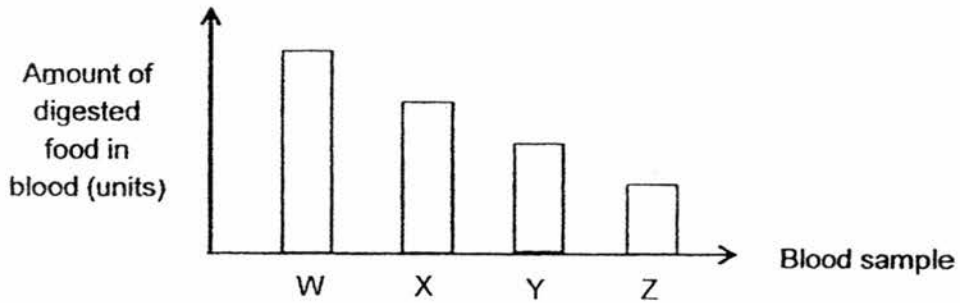

Which blood vessel was the blood sample W most likely taken from?

- | | |
|-------|-------|
| (1) A | (2) B |
| (3) C | (4) D |

- 10 Zachary wanted to investigate how digestion takes place in the body. He took samples of food as it passed through five parts, A, B, C, D and E, of the digestive system as shown below.

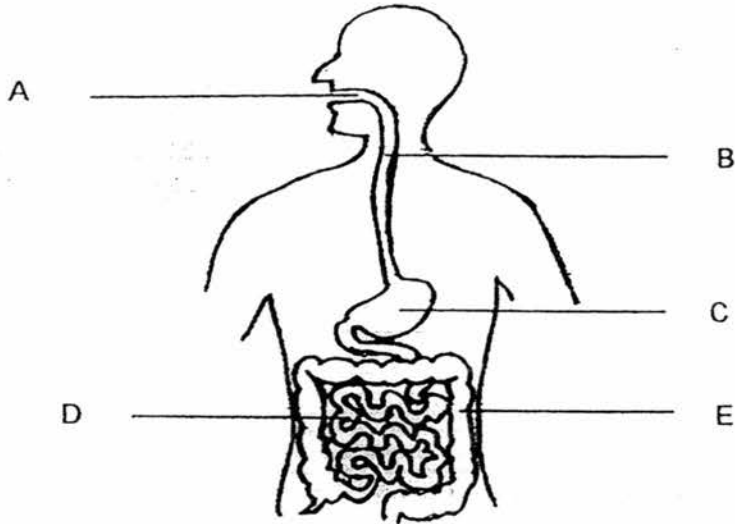

He plotted the amount of undigested food at the five parts on a graph below. Which line best represents the relative amount of undigested food in the various parts of the human digestive system?

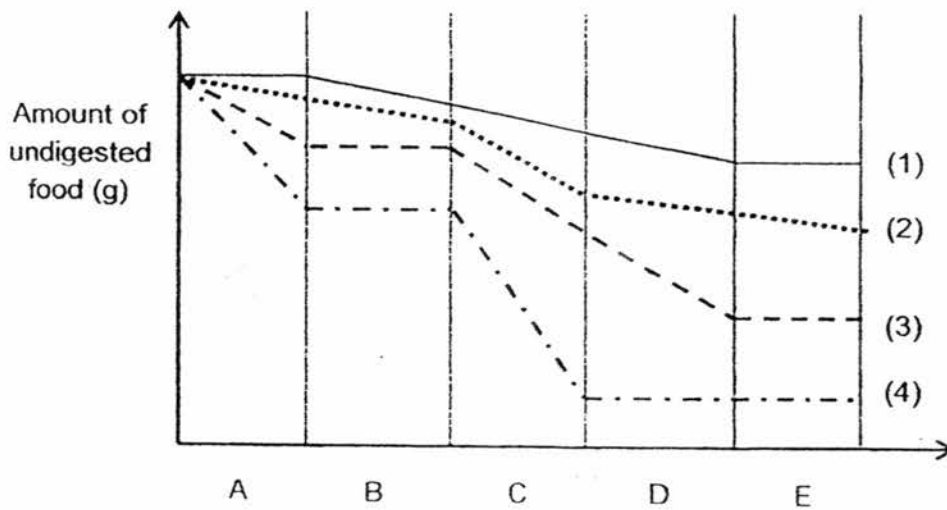

- 11 Hamid had 4 water samples, A, B, C and D, collected from different parts of the same river. Using the same amount of each water sample, he set up the following apparatus using the same amount of water plant. He placed the 4 set-ups near a window for 3 days.

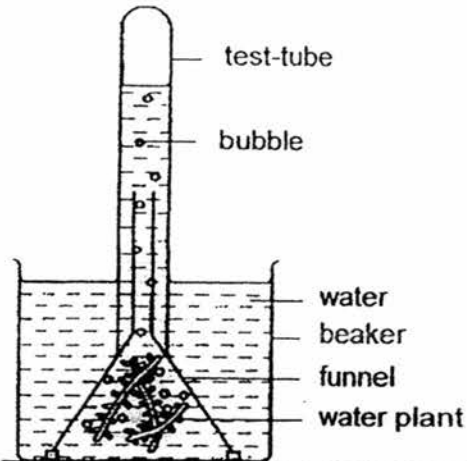

At the end of the experiment, Hamid compared the amount of oxygen produced by the water plants and recorded his observation in the table shown below.

Water sample	Volume of oxygen collected (cm ³)
A	14
B	20
C	18
D	10

Hamid made the following conclusions:

- A: The water plants in all the water samples photosynthesized at different rates.
- B: The water samples used affected the rate of photosynthesis of the water plants.
- C: The water is not polluted at the parts of the river where water samples B and C were collected from.
- D: The rate of photosynthesis of the water plants was dependent on the amount of sunlight that reached each plant.

Based on Hamid's experimental results above, which of his conclusions are correct?

- (1) A and B only
- (2) C and D only
- (3) A, B and D only
- (4) A, B, C and D

- 12 Joseph carried out an experiment to find out if the brightness of the light will affect the amount of gas produced. He set up the apparatus as shown below.

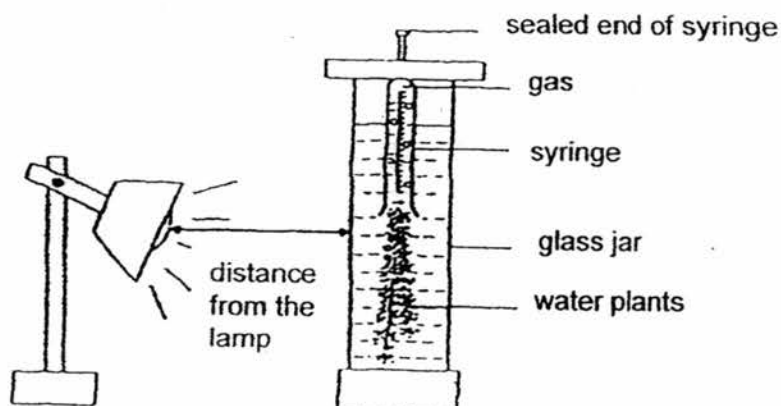

In order to ensure a fair test, he should only change the _____.

- (1) type of water plants used
 (2) amount of water plants used
 (3) amount of water in the glass jar
 (4) distance between the lamp and the glass jar
- 13 Mr Quek noticed some mealybugs feeding on a plant in the Community Garden. He made the following observations:
- The mealybugs damaged the plant while feeding on the plant sap.
 - There were many black ants crawling all over the plant.
 - The ants were feeding on the honeydew or waste produced by the mealybugs.
 - Ladybugs appeared on the plant after a few days and were seen feeding on the mealybugs.
 - The ants were seen attacking the ladybugs.

Based on the interactions as stated above, which one of the following correctly states the relationship between the different organisms?

	Both organisms benefitted	Only one out of the following organisms benefitted
(1)	ant and plant	mealybug and ladybug
(2)	mealybug and ladybug	mealybug and ant
(3)	mealybug and ant	mealybug and plant
(4)	ant and ladybug	ant and plant

14 The diagram below shows a model of a food chain.

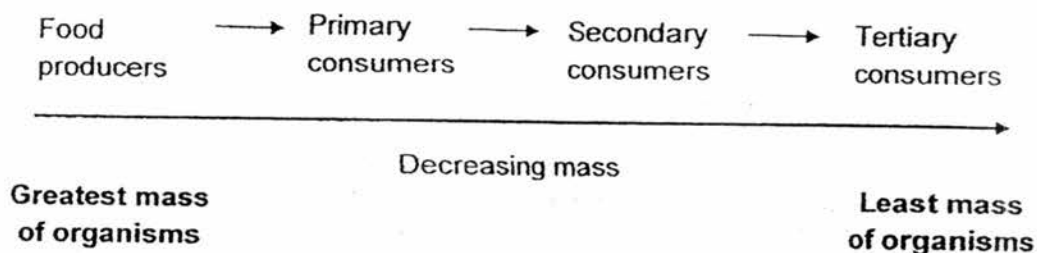

The graph below shows the masses of the organisms that form a food chain in a lake at the Gardens by the Bay.

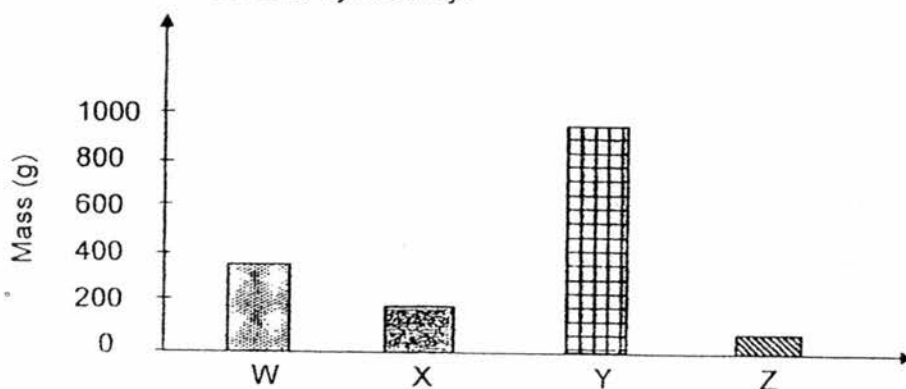

Based on the given information above, deduce which part of the food chain each organism belongs to.

	Food producer	Primary consumer	Secondary consumer	Tertiary consumer
(1)	Y	X	W	Z
(2)	W	X	Z	Y
(3)	Y	W	X	Z
(4)	W	Z	X	Y

- 15 One way of measuring water quality in rivers is by examining the types of fish, insects and other invertebrates that the water will support. Different aquatic animals are able to tolerate different levels of pollutants. As the level of pollutants increases, the number of sensitive animals will decrease and the number of tolerant animals will increase.

The chart below shows the tolerance of some aquatic organisms to water pollutants.

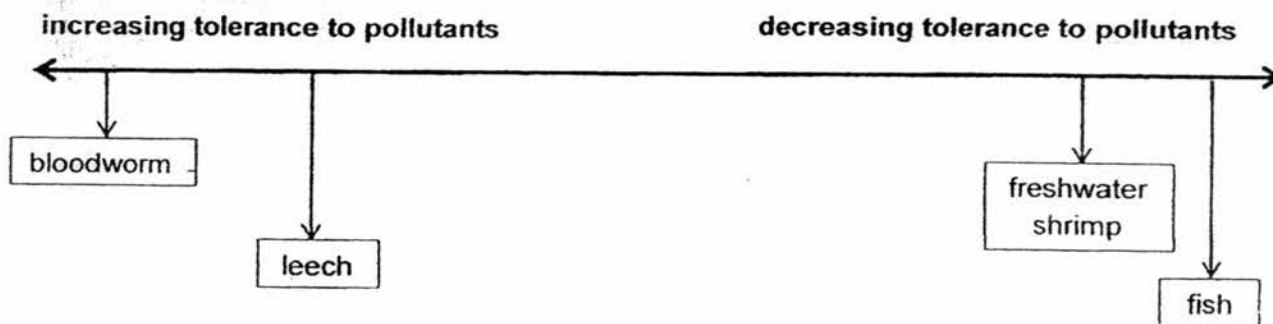

During a random check, an environmental officer counted the number of individual organisms in water samples taken from 4 different rivers and recorded his results in the table below.

River	bloodworm	leech	freshwater shrimp	fish
A	4	5	5	3
B	2	2	6	5
C	6	4	2	0
D	8	5	0	0

Arrange the rivers from the most polluted to the least polluted.

	most polluted		least polluted	
(1)	C	D	A	B
(2)	B	A	C	D
(3)	D	C	B	A
(4)	D	C	A	B

16 Study the flow chart below carefully.

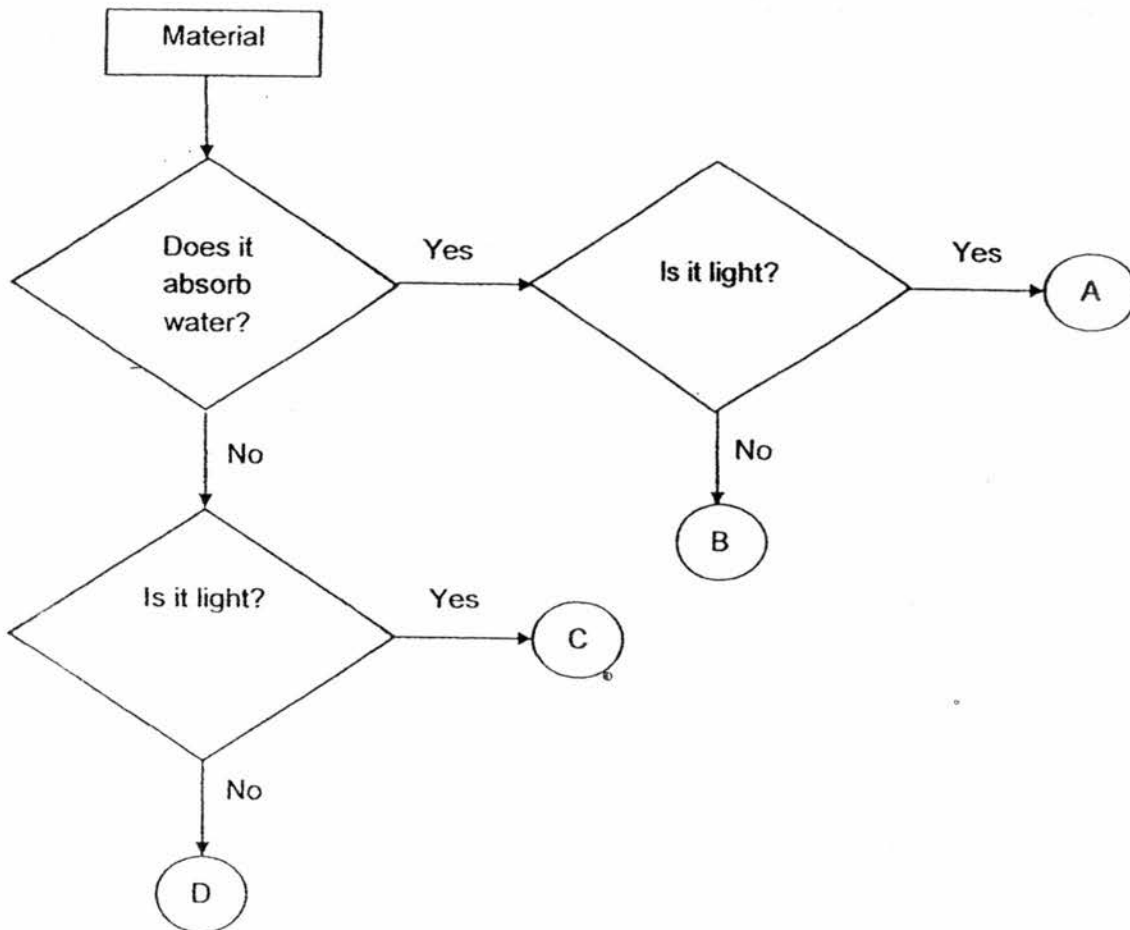

Refer to part R of the shoes as shown below.

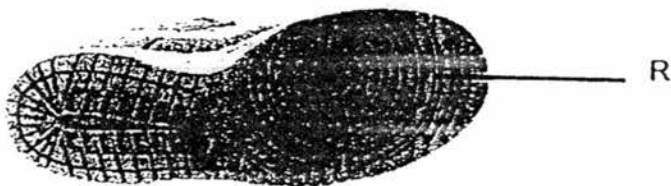

Which of the letter, A, B, C or D, matches with the material used to make part R of the shoe?

- | | |
|-------|-------|
| (1) A | (2) B |
| (3) C | (4) D |

Test		
A	B	C
Can it be attracted to another magnet?	Does it come to a rest pointing in N-S direction when suspended freely?	Can it repel another magnet?

- (1) Test B only (2) Test C only
(3) Tests A and B only (4) Tests B and C only

18 A shadow is formed because _____.

- A: light can be blocked.
B: light can be reflected.
C: light can be absorbed.

- (1) A only (2) C only
(3) A and B only (4) A, B and C

19 Why is air classified as a matter?

- A: Air has mass.
B: Air occupies space.
C: Air can be compressed.

- (1) A only (2) A and B only
(3) B and C only (4) A, B and C

- 20 The table below shows the melting points of substances P, Q, R and S.

Substance	Melting Point ($^{\circ}\text{C}$)
P	49
Q	15
R	23
S	5

At which temperature will two of the above substances be at its liquid state?

- (1) 0°C (2) 10°C
 (3) 20°C (4) 30°C
- 21 Andy recorded the volume of four objects and the volume of water the objects can displace when put into a measuring cylinder.

Object	Volume of the object (cm^3)	Volume of water displaced by the object (cm^3)
W	20	20
X	40	10
Y	60	30
Z	80	5

Andy studied the water tank used for flushing a toilet bowl in his house as shown below. After flushing, water enters and re-fills the tank. The tank will stop filling when the water reaches level L.

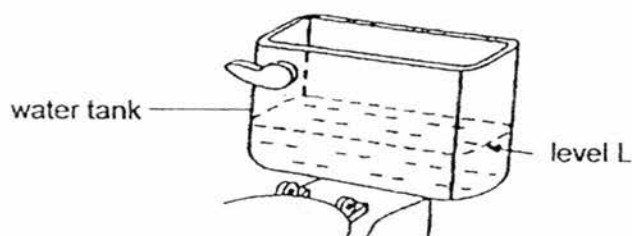

Based on the results above, which object W, X, Y or Z should Andy put inside the water tank so that he would use the least water to flush the toilet?

- (1) W (2) X
 (3) Y (4) Z

- 22 Li Fei was holding a metal spoon with a cube of ice as shown. After some time, she felt that the spoon was cold.



Which one of the following correctly explains why Li Fei felt that the spoon was cold?

- (1) The spoon lost heat to the ice and to her hand.
- (2) The spoon gained heat from the ice and from her hand.
- (3) The spoon lost heat to the ice and gained heat from her hand.
- (4) The spoon gained heat from the ice and lost heat to her hand.

- 23 Four steel rods of equal thickness but different lengths were heated to the temperatures indicated in the diagrams below.

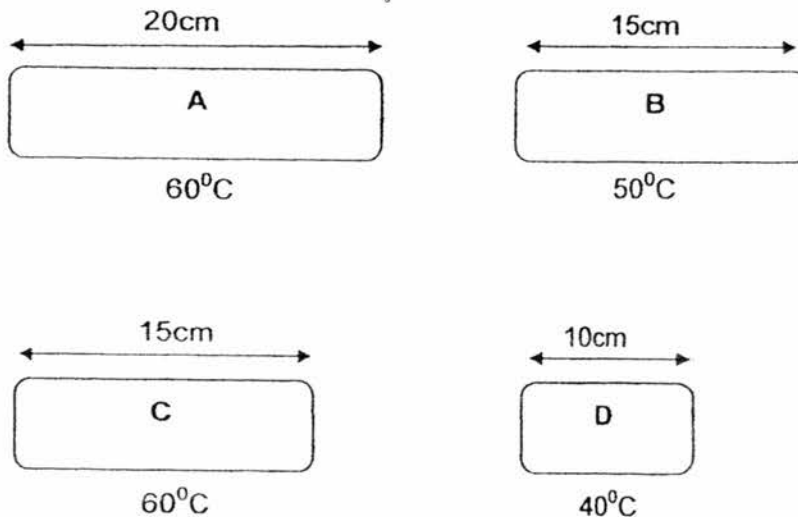

Ali wanted to investigate if the amount of heat the object has is affected by the mass of the object and its temperature. Which one of the following should he compare?

- (1) A, B and C only
- (2) A, B and D only
- (3) A, C and D only
- (4) B, C and D only

- 24 David stirred a white solid in some water and it became a clear liquid. He then poured the clear liquid into a container. Finally, he placed a cardboard boat in the container filled with the clear liquid.

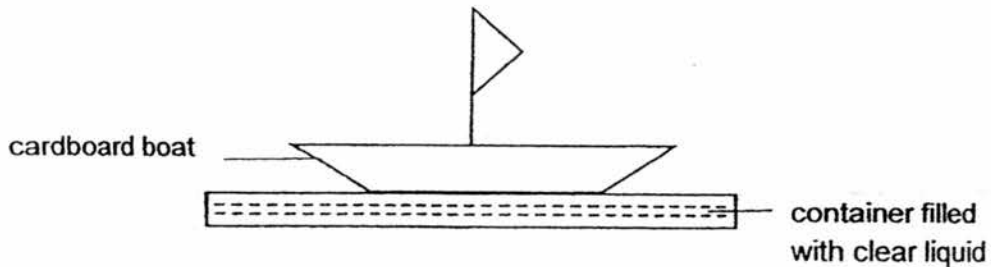

At first, the boat looked wet. Then he placed the boat on a table.

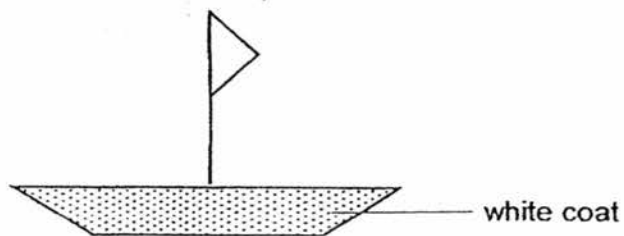

After a few days, David observed a white coat on the boat. The above observation is possible due to _____.

- | | |
|-----------------|------------------|
| (1) melting | (2) freezing |
| (3) evaporation | (4) condensation |

25 Study the water cycle below.

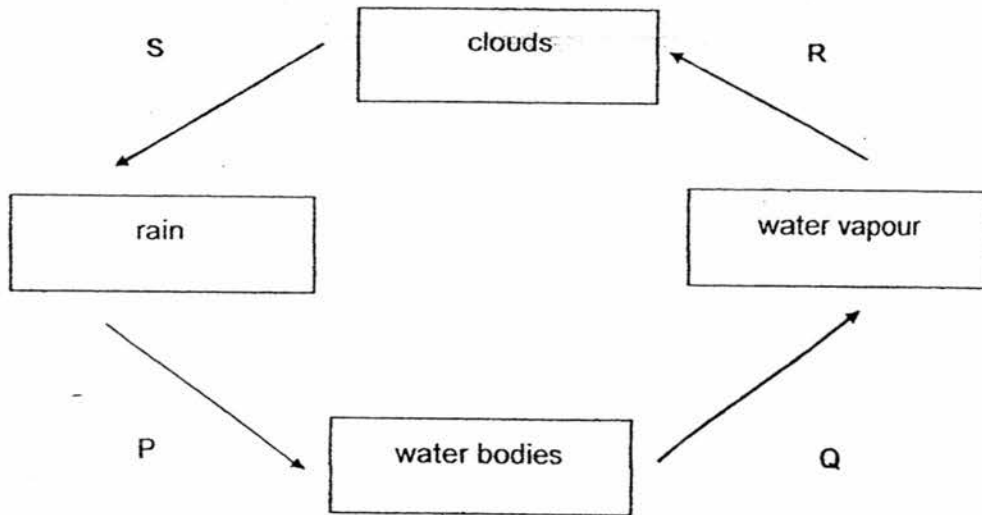

Which one of the following statements about the water cycle is true?

- (1) Heat gain is needed at P.
- (2) There is energy conversion at Q.
- (3) Heat loss from the surrounding air is needed at R.
- (4) There is a change of state at S.

26 Abby has an electric circuit as shown below.

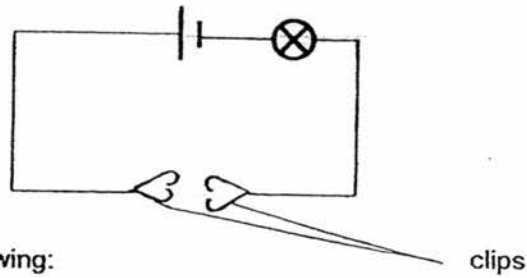

He did the following:

1. Joined the clips and measured the brightness of the bulb.
2. Added an object between the clips and measured the brightness of the bulb.
3. Compared the brightness of the bulb between steps 1 and 2.
4. Repeated steps 2 and 3 for three other objects.

Which one of the following is a possible observation?

	Objects	The brightness of the bulb is _____ compared to no object between the clips.
(1)	electric bell	brighter
(2)	bulb	dimmer
(3)	battery	the same
(4)	copper wire	brighter

- 27 Study the four electrical circuits as shown below. All the batteries and bulbs are similar.

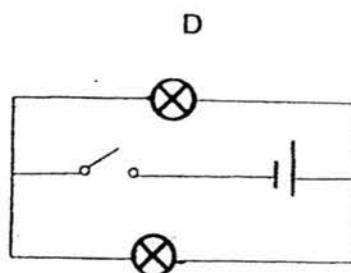
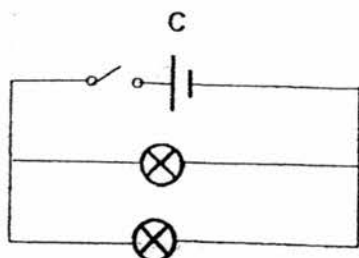
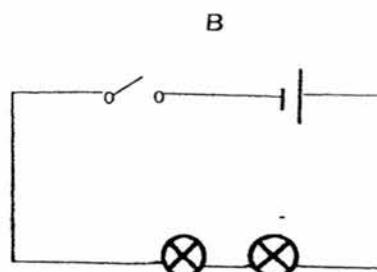
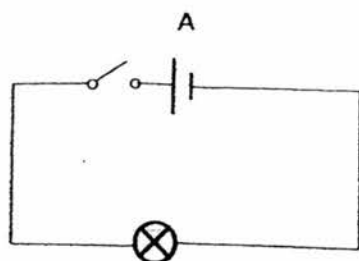

In which circuits will the bulbs be of the same brightness?

- | | |
|---------------------|---------------------|
| (1) B and C only | (2) C and D only |
| (3) A, C and D only | (4) B, C and D only |
- 28 Which of the following effects of forces are true?
- A: A force may change the shape of an object.
 B: A force can change the speed of a moving object.
 C: A force can change the direction of a moving object.
 D: A force can change the size of a gas trapped in a balloon.
- | | |
|---------------------|-------------------|
| (1) A and B only | (2) C and D only |
| (3) B, C and D only | (4) A, B, C and D |

29 The diagram below shows two 40 kg students ready to dive into the pool.

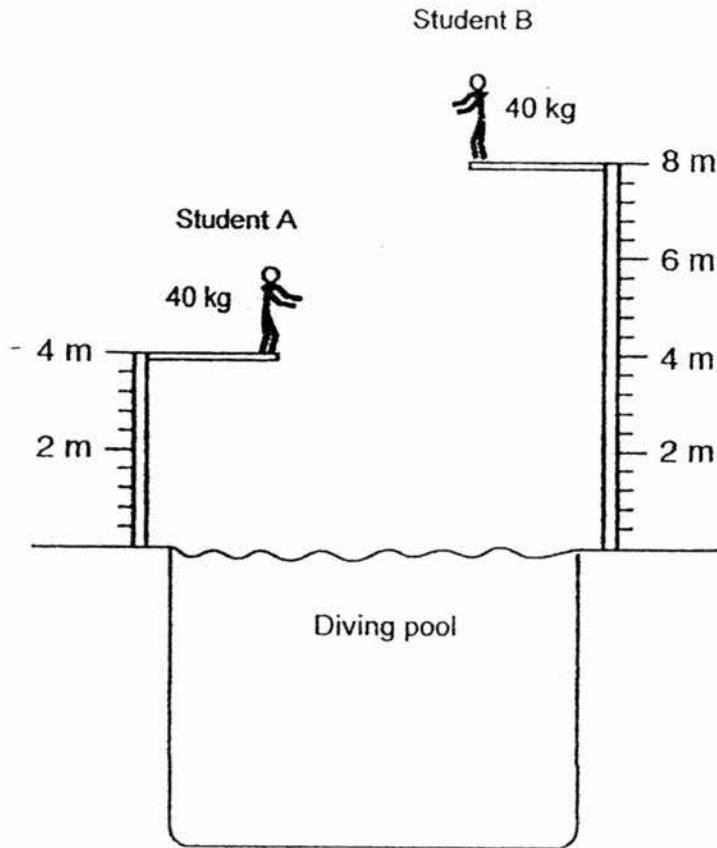

Which one of the following is a possible aim for the experiment?

- (1) To find out if the mass of a person will affect the depth of the dive.
- (2) To find out if amount of potential energy will affect the depth of the dive.
- (3) To find out if amount of water resistance will affect the depth of the dive.
- (4) To find out if amount of gravitational force will affect the depth of the dive.

- 30 Some students wanted to find a suitable fabric to make a bathmat. They placed the fabric on a ramp and put a weight on it to represent a person standing on it. They raised the height until the weight started to slide off the fabric.

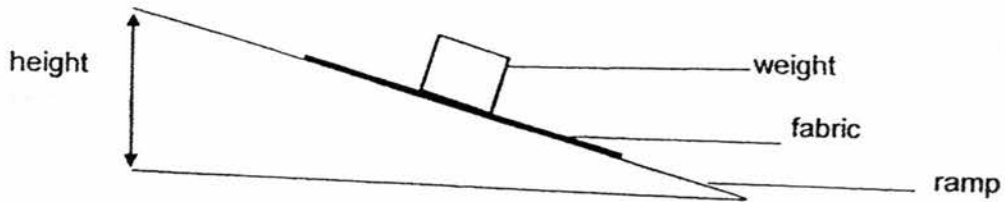

The results were as shown below.

Fabric	Height at which the weight started to slide off the fabric (cm)
P	8
Q	17

Based on the results obtained, which fabric will be more suitable for making the bathmat and why?

	Fabric	Reason
(1)	P	There is greater friction between the mat and the floor.
(2)	P	There is greater friction between the mat and the feet.
(3)	Q	There is greater friction between the mat and the floor.
(4)	Q	There is greater friction between the mat and the feet.

END OF BOOKLET A



Rosyth School
Preliminary Examination 2016
STANDARD SCIENCE
Primary 6

Name: _____

Total
Marks:

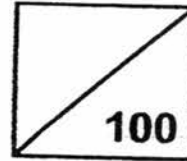

Class: - Pr 6 _____ Register No. _____ Duration: 1 h 45 min

Date: 25 August 2016 Parent's Signature: _____

Booklet B

Instructions to Pupils:

1. For questions 31 to 44, give your answers in the spaces given in Booklet B.

	Maximum	Marks Obtained
Booklet A	60 marks	
Booklet B	40 marks	
Total	100 marks	

* This booklet consists of 20 printed pages (including cover page).

Part II

For questions 31 to 44, write your answers in the space provided. **(40 Marks)**

- 31 Farmer Rajah made some observations on similar-sized mangoes on a mango tree in his plantation. He made two bark removals on two different parts of the mango tree. He removed the outer ring of the bark on the main trunk and on a lower branch. Only the food-carrying tubes were removed in the cuts made while the water-carrying tubes remained intact.

The two cuts are indicated as X on the main trunk and Y on the branch as shown in the diagram below.

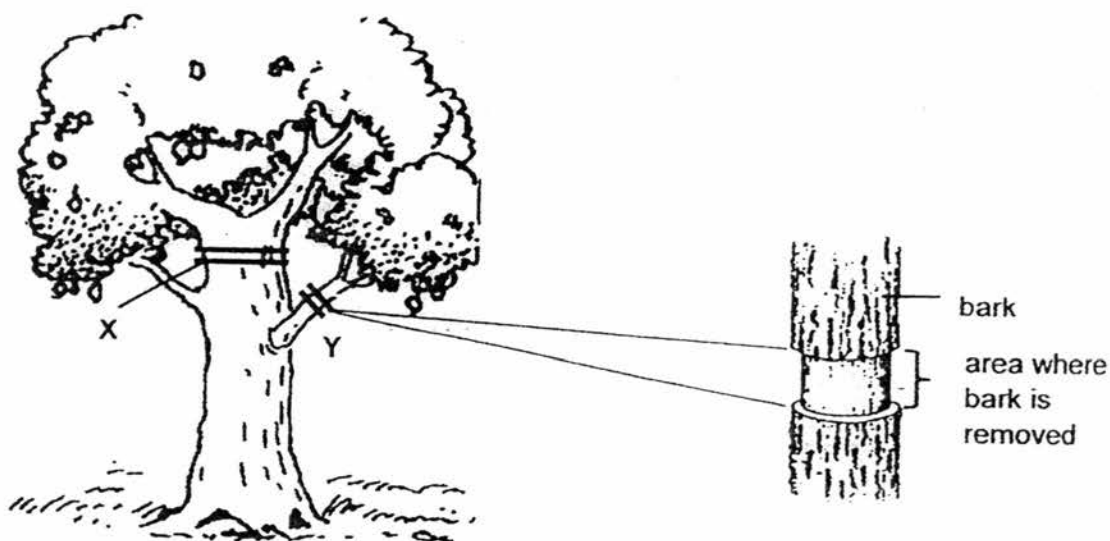

After a few weeks, both branches above cuts X and Y bore fruits.

Branches above cut X bore bigger fruits. Explain your answer. [2]

- 32 Joyce placed four identical leather shoes in four identical sealed boxes. She placed boxes P and Q in a cold place and boxes R and S in a warm place. Substance Y was used to absorb water vapour from the surrounding.

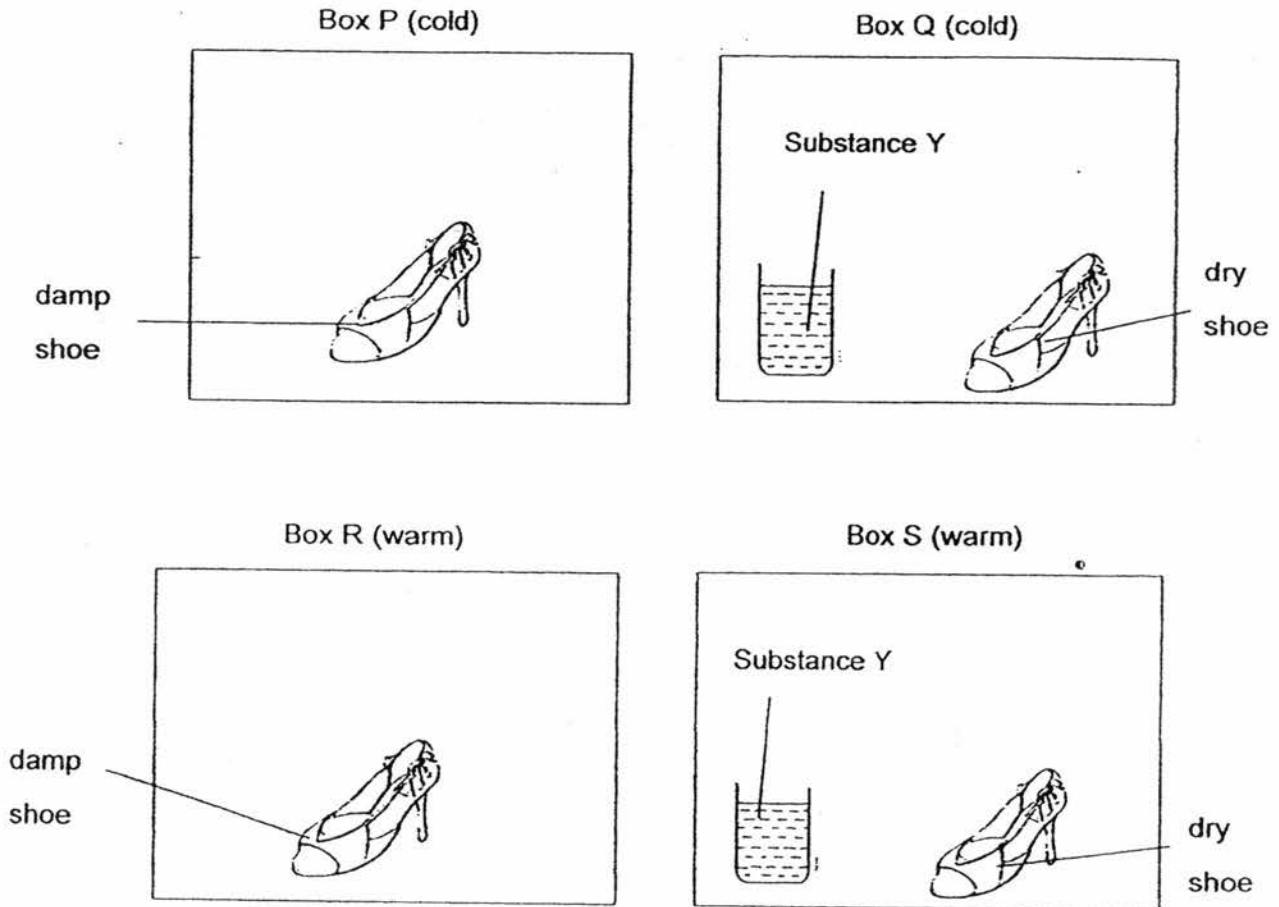

- (a) In which box, P, Q, R or S, would fungus first appear on the shoe? Explain your answer. [1]

Question 32 continues on page 3

- (b) While showering, Joyce noticed patches of black mould growing on the ceiling surface of her bathroom.

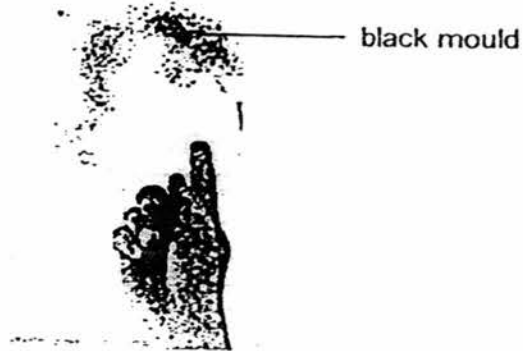

Her mother advised her to open the bathroom windows immediately after her shower everyday.

Explain how this action would help to reduce the growth of mould on the ceiling. [2]

- 33 Dengue fever is an illness caused by infection transmitted by the *Aedes* mosquito. Lisa studied the life cycle of the *Aedes* mosquitoes at different temperatures of the water.

Life cycle of the *Aedes* Mosquito

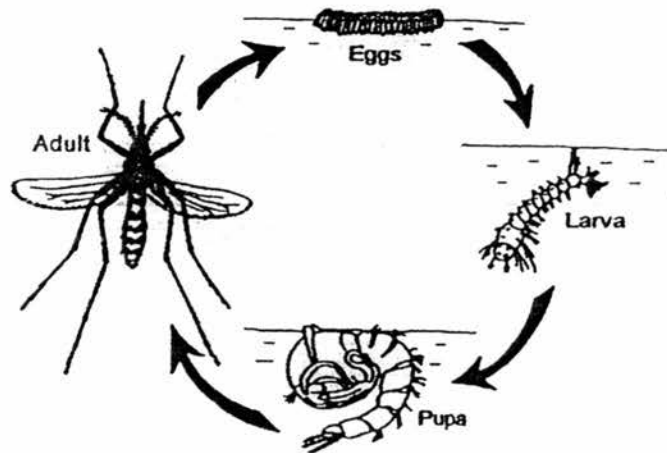

The results are shown below:

Duration of stages across water of different temperatures (Days)				
	23 °C	25 °C	27 °C	29 °C
egg	2	2	2	2
larva	10	8	6	4
pupa	2	2	2	2

- (a) Based on the results in the table above, what is the relationship between the temperature of the water and the length of the life cycle of the *Aedes* mosquito? [1]

Dengue infection and transmission depends on the seasonal variation of the climate of a country. Graphs A and B below show the number of dengue cases and the average amount of rainfall in Singapore for a period of one year.

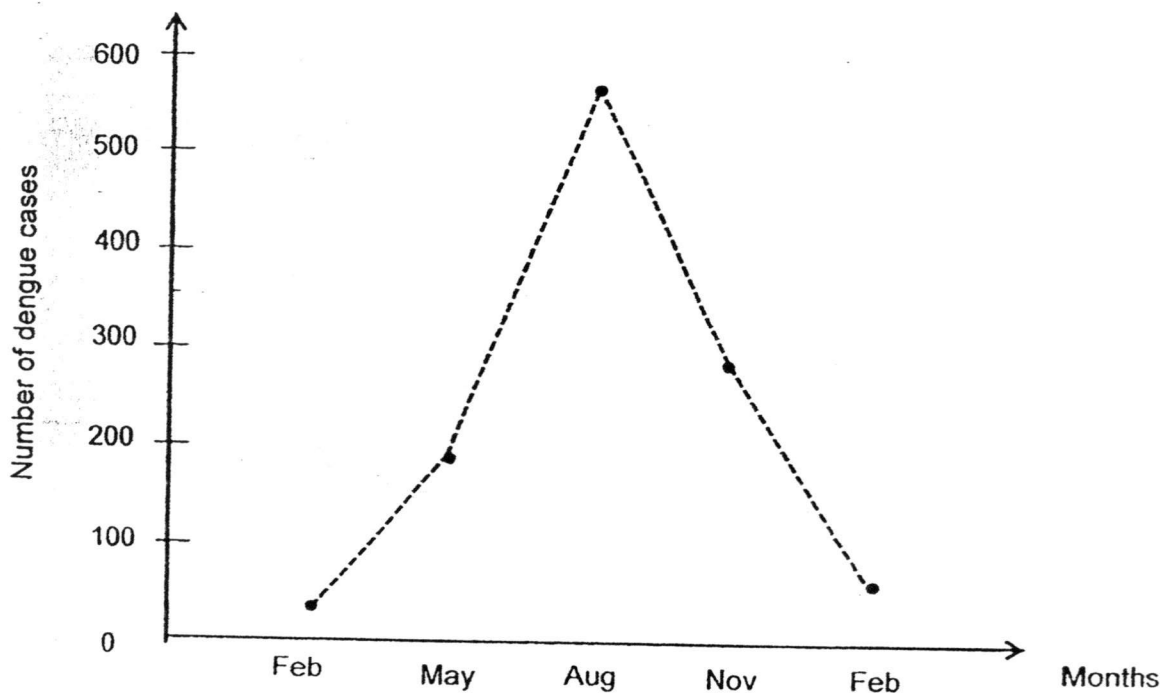

Graph A

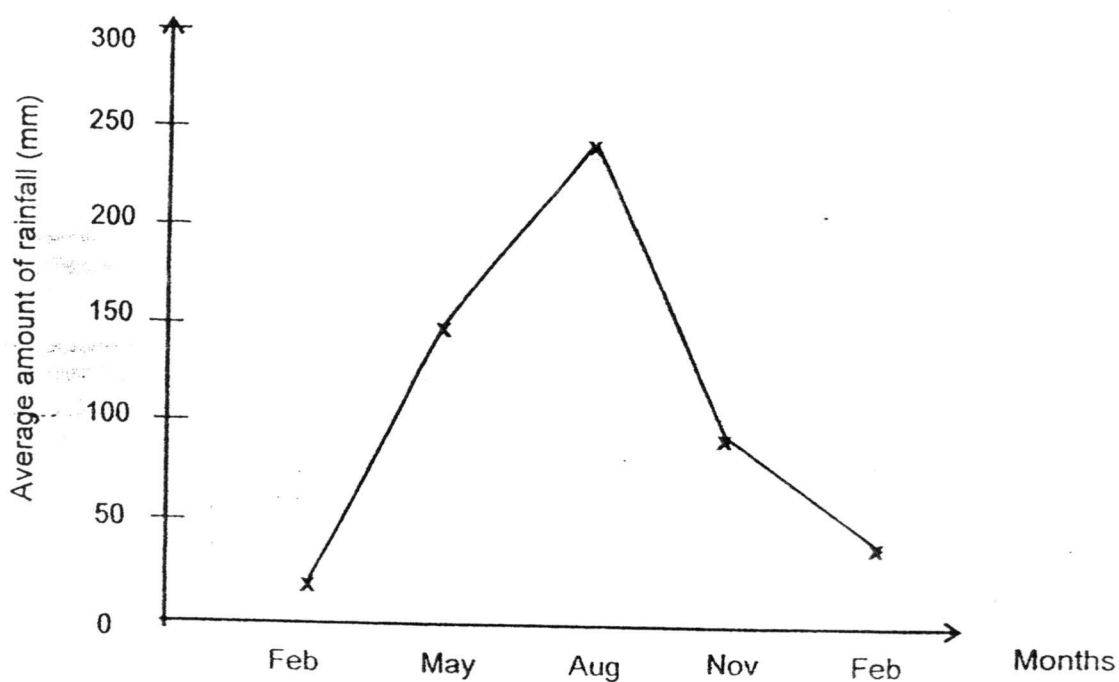

Graph B

Question 33 continues on page 6

- (b) Study the graphs and identify the period when there is a sudden increase in the number of dengue cases. Tick the appropriate box below. [1]

February to May

May to August

August to November

November to February

- (c) Give a reason for the sudden increase in the number of dengue cases in relation to the life cycle of the *Aedes* mosquito. [2]

- 34 The diagram below shows the lungs of a human and how gaseous exchange takes place at the air sacs.

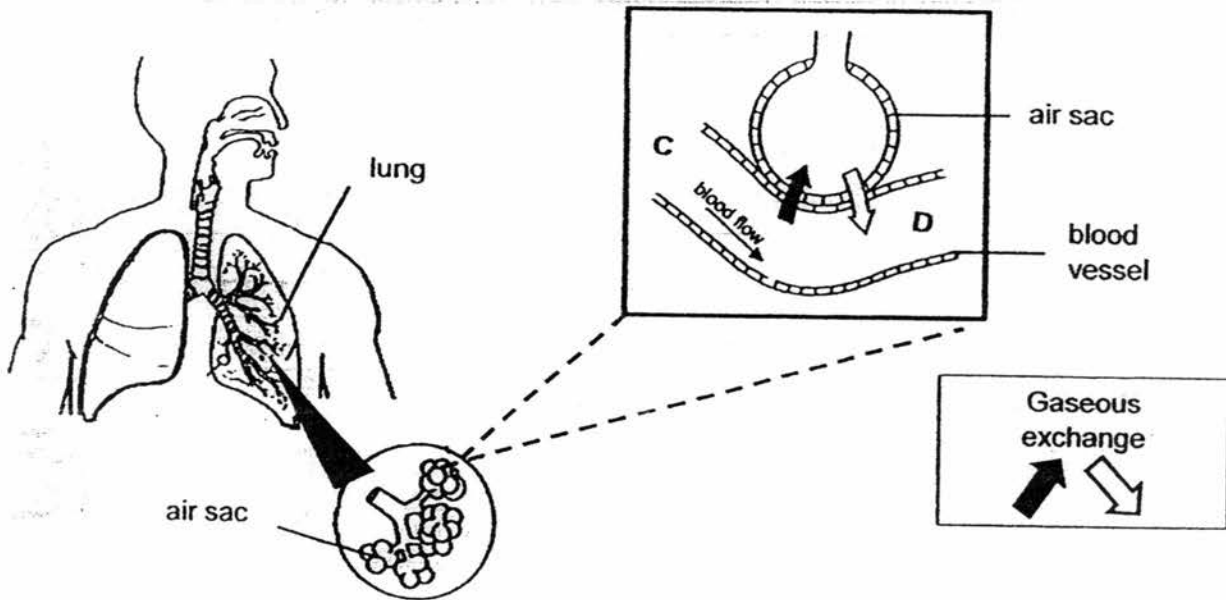

Gases P and Q are found in the blood at parts C and D of the blood vessel. The amount of gases P and Q found in C and D is represented in the bar graphs below.

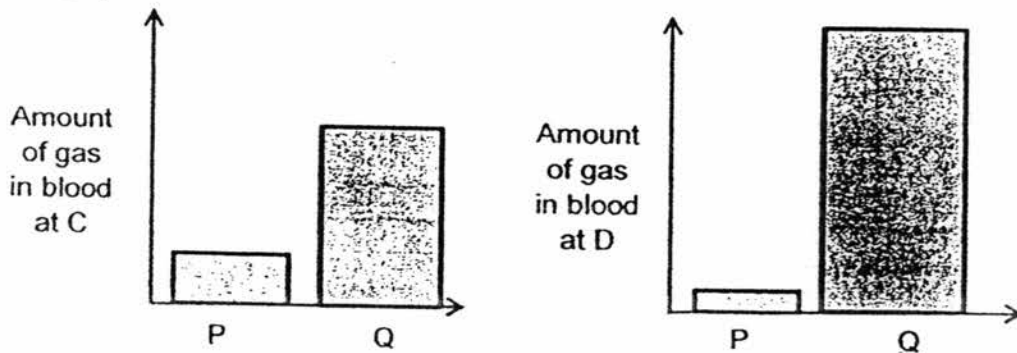

- (a) Identify gases P and Q. [1]
- (i) P is _____
- (ii) Q is _____
- (b) Describe how two systems in the human body work together to ensure the circulation of gas Q in the body. [2]

- 35 Joseph carried out an experiment as shown below in a dark room. He measured the amount of gas collected in the test tube after shining different colours of light at plant P for 3 hours each.

At the start of the experiment

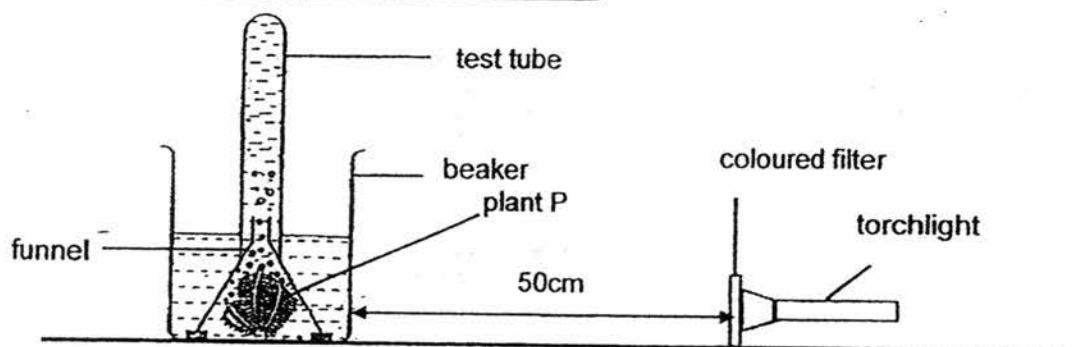

After 3 hours

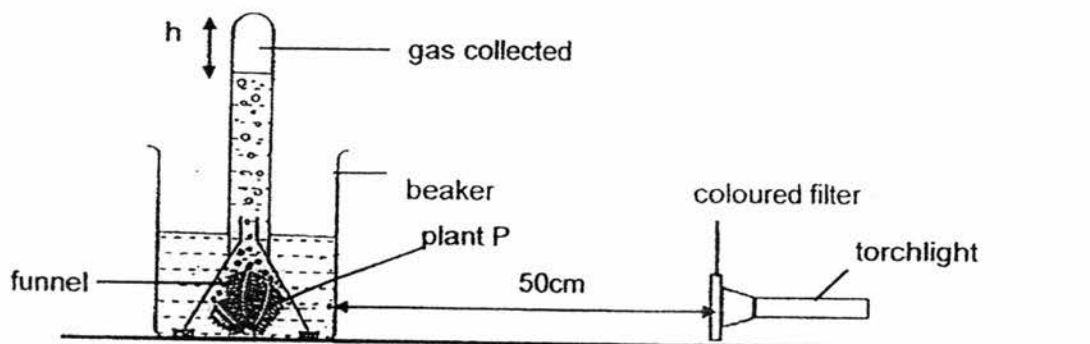

His results were recorded in the table below.

Colour of the light	Height of h (cm)
white	3
blue	7
green	2

Joseph has an aquarium containing some plants P and some fishes. He did not put an air pump in his aquarium.

Which colour of light (white, blue or green) should he use to shine on his aquarium in order to allow his fish to survive the longest period of time?
Explain your answer.

[2]

36 The graph below shows the average amount of carbon dioxide in the atmosphere from 1960 to 2010.

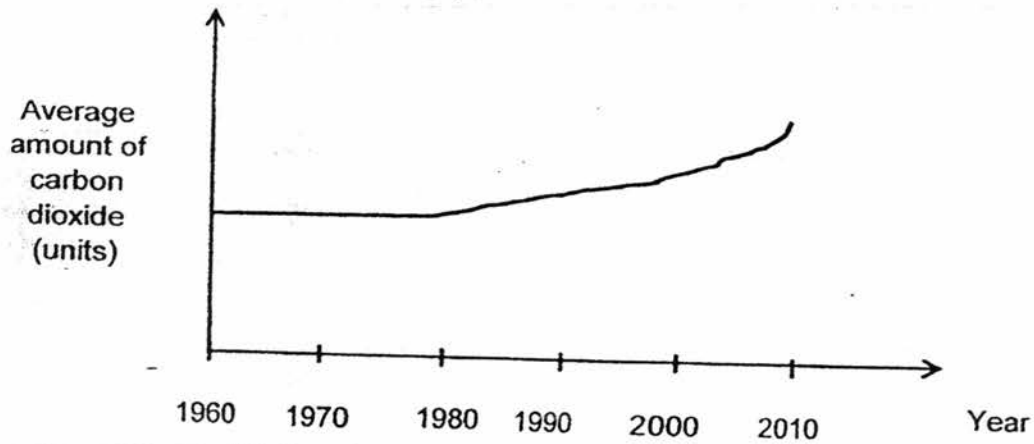

The graph below shows the average global temperature readings from 1960 to 2010.

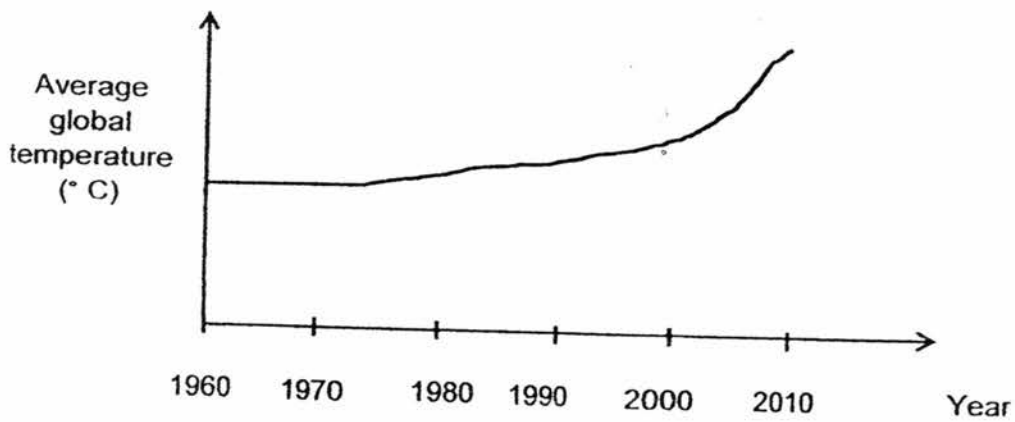

(a) What is the relationship between the amount of carbon dioxide in the atmosphere and the average global temperature?

[1]

(b) Explain how reforestation (extensive planting of trees) could reduce the average global temperature over time.

[1]

- 37 John studied about animal X. It lives in shallow streams. It breathes through lungs. It also has gills that cannot be used for breathing.

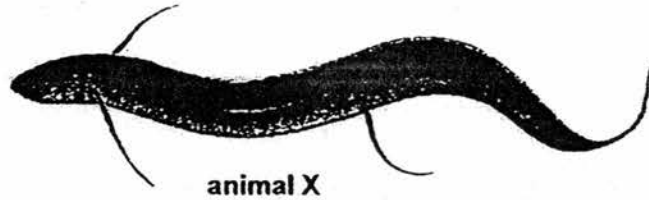

During the hot and dry season, animal X burrows into the mud at the bottom of dried up streams. It covers its entire body in a mucous 'cocoon' which traps moisture and lets in air slowly through an opening. As the animal goes into a deep sleep, its activity level slows down. It can stay inactive for as long as four years until the rainy season returns and restores its aquatic habitat.

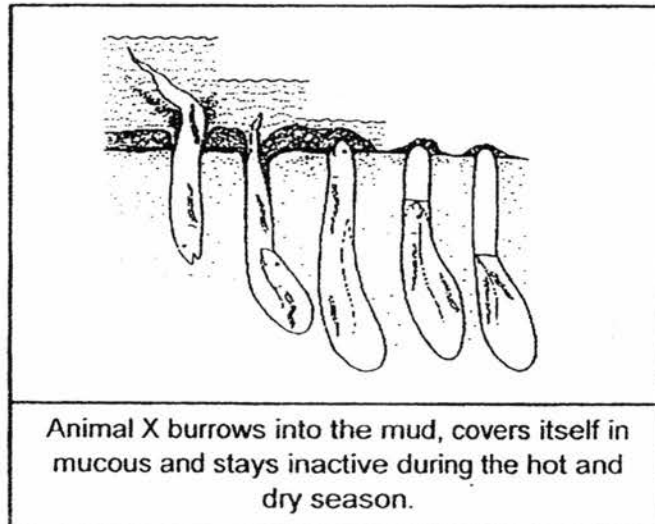

- (a) State two physical factors of the environment which affect the survival of animal X. [1]

- (i) _____
- (ii) _____

Question 37 continues on page 11

(b) State how the following structural and behavioral adaptations help animal X. [2]

(i) Structural adaptation: streamlined body

How it helps: _____

(ii) Behavioral adaptation: covers body with mucous

How it helps: _____

(c) Explain how the change in activity level of animal X during the hot and dry season affects its rate of breathing. [1]

- 38 A company was investigating on the effects of its products A, B and C on hair quality. Good quality hair should be able to absorb moisture and retain it, be elastic and strong.

After using the same amount of products A, B and C on different parts of a person's hair for one week, three of the following tests were carried out.

Test 1

1. Fill a glass or bowl with water at room temperature.
2. Take a few strands of clean hair and put them in the water.
3. Observe it for 2-4 minutes.

The results were recorded as shown below.

Product	A	B	C
Observation	Hair is slowly sinking	Hair is still floating after 4 minutes	Hair sinks immediately

- (a) Which product A, B or C has improved the hair quality the most? Explain why. [1]

Test 2

Next, it wanted to investigate the efficiency of its products A, B and C on improving the elasticity of hair. A few strands of wet hair were selected on the head. The strands of hair were held securely, pulled and released.

- (b) What result should be measured in Test 2? [1]

Lastly, the company investigated on how strong the hair was after using the products for a week. The results of Test 3 were recorded as shown below.

Product	Average number of hair pulled out from the head
A	8
B	6
C	12

- (c) Based on the table above, what must the company do to ensure that the investigation is fair? [1]

- 39 Ansel wanted to know which cup is the best to keep water hot for a long period. He used the cups as shown below. All the cups are made of the same glass.

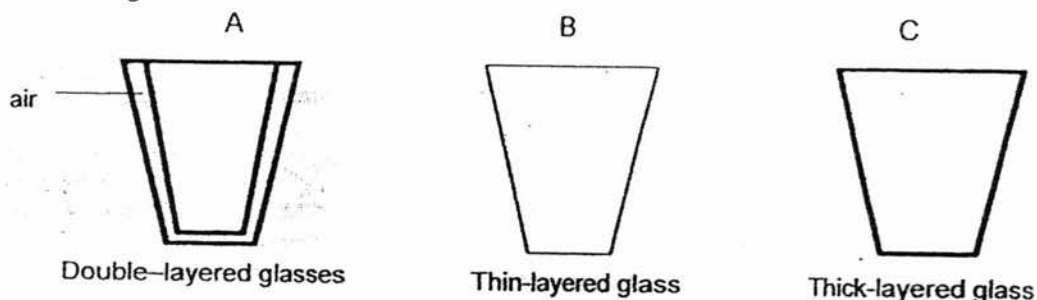

He measured the temperature of water at the start of the experiment. After 20 minutes, he measured the temperature of water in each cup and recorded the results as shown below.

Cup	Temperature of water at the start of the experiment ($^{\circ}\text{C}$)	Temperature of water after 20 minutes ($^{\circ}\text{C}$)
	70	60
	70	54
	70	40

- (a) Write A, B and C in the table above to match the cups with the respective results. [1]
- (b) Ansel noticed that most houses have glass windows. Which glass A, B or C is most suitable for the windows in a house during winter? Explain why. [2]

Ansel observed that the window of the house was made of a special glass. On a sunny day, the glass window became translucent as shown below.



- (c) How does this change help to keep the house cooler on a sunny day? [1]

40 Alex has a fish tank as shown below.

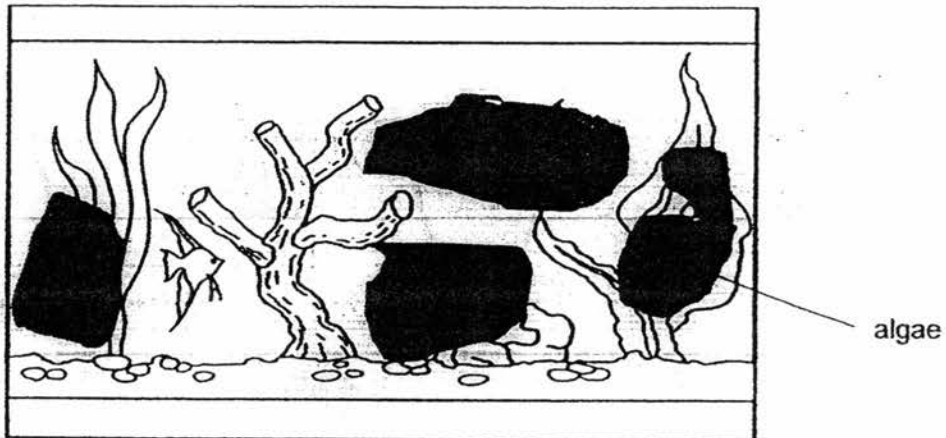

Inside the tank, he observed algae growing on the inner surface of the fish tank. He wants to clean off the algae using two magnets only.

- (a) Describe how the inner surface of the tank can be cleaned using two magnets. [2]

- (b) State the property of the magnet that enables Alex to do as stated in (a). [1]

41 Study the diagram below.

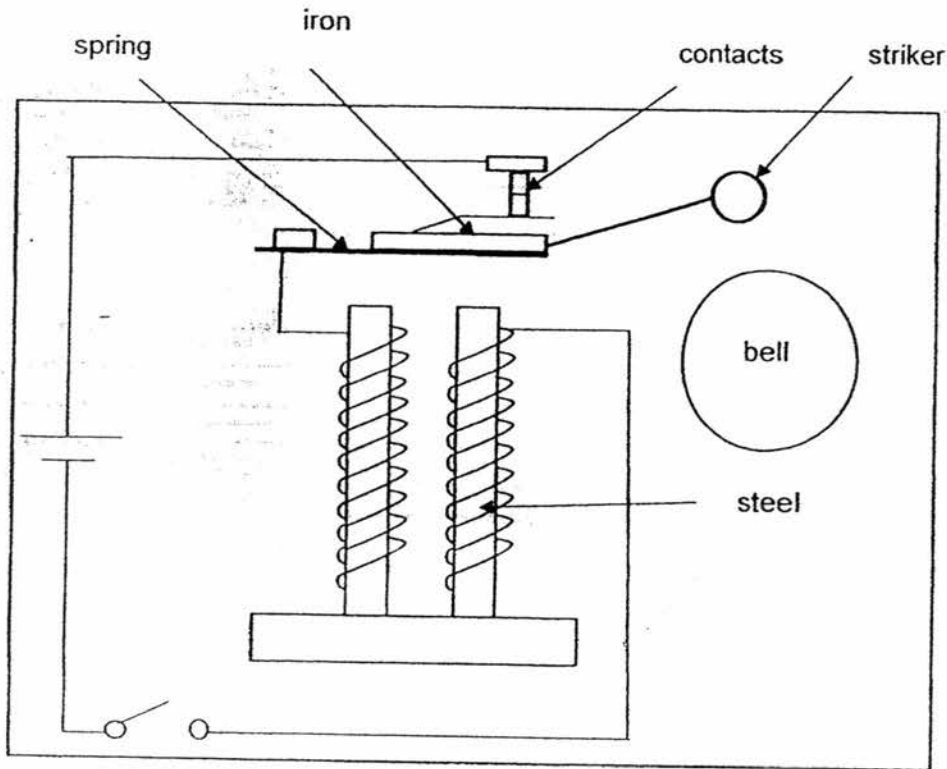

(a) Describe how the circuit works for the striker to hit the bell once. [2]

(b) What is the advantage of using an electromagnet in the circuit above? [1]

- 42 Bullet trains travel at a super-fast speed using electricity. A scientist investigated on the shape of the nose to prevent the train from slowing down.

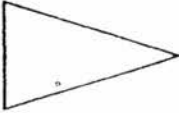

The speed at which the air is pushed and the intensity of sound produced were measured as the train exited the tunnel.

Type of nose	Shape of the nose	Speed at which the air is pushed	Intensity of sound produced
1		High	High
2		Low	Low

- (a) Complete the energy conversion as the train exited the tunnel. [1]

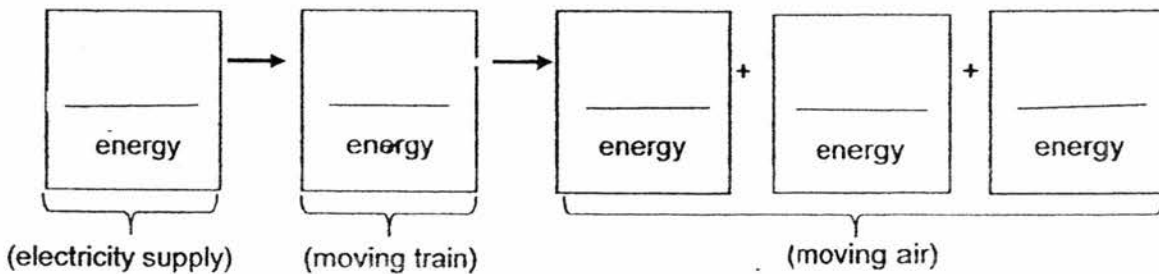

- (b) Explain why the train uses more electrical energy when nose 1 was used. [1]

Question 42 continues on page 17

The nose 2 of the bullet train was designed based on the beak of the kingfisher.



- (c) Based on the results above, explain how the kingfisher's beak enables it to dive into the water without a big splash. [1]

- 43 Siti prepared two set-ups X and Y as shown below. She placed two glass containers into a basin of water at a certain temperature. Then she placed the glass lids at different temperatures on each glass container.

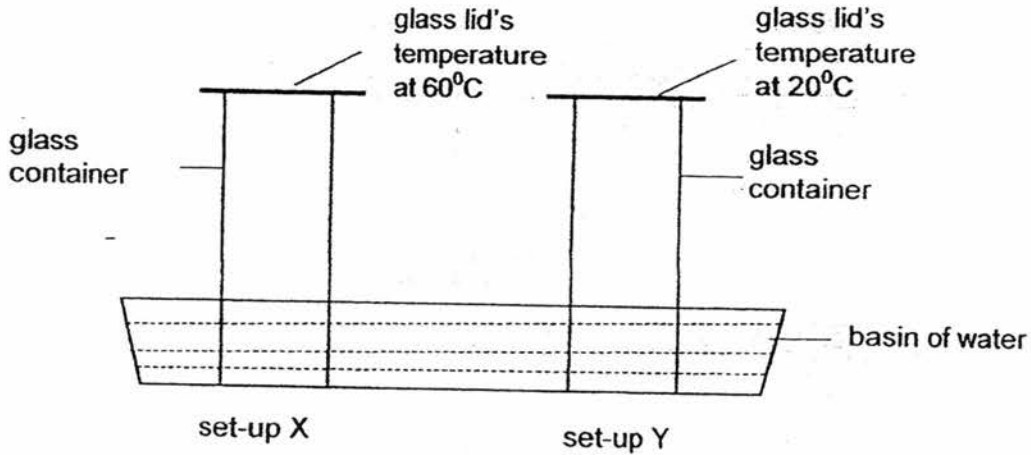

After some time, she observed water droplets formed on the underside of the glass lids inside the glass containers in both set-ups.

There were more water droplets formed in set-up Y than in set-up X.

- (a) Predict the temperature of the water in the basin at the start of the experiment. [1]

- (b) Why were both set-ups placed in the same basin of water? [1]

- 44 The amount of potential and kinetic energy were measured as Ahmad surfed down the slope from point R to S as shown below.

Legend

PE= Potential Energy
KE= Kinetic Energy

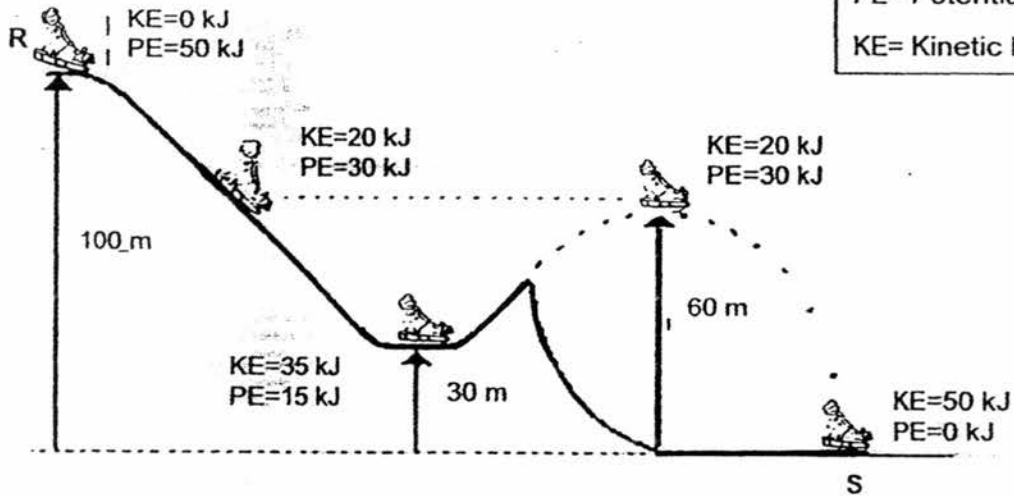

- (a) State the relationship between the height of the slope and the amount of potential energy as Ahmad surfed down from point R and flew in the air to land at point S. [1]

- (b) Based on the results above, what happened to the total amount of energy as Ahmad surfed down the slope? Explain your answer. [1]

End of Booklet B

YEAR : **2016**
LEVEL : **PRIMARY 6**
SCHOOL : **ROSYTH**
SUBJECT : **SCIENCE**
TERM : **PRELIMINARY EXAMINATION**

Booklet A

Q1	Q2	Q3	Q4	Q5	Q6	Q7	Q8	Q9	Q10
1	3	2	2	4	1	2	2	2	3
Q11	Q12	Q13	Q14	Q15	Q16	Q17	Q18	Q19	Q20
1	4	3	3	4	3	3	1	2	3
Q21	Q22	Q23	Q24	Q25	Q26	Q27	Q28	Q29	Q30
3	3	1	3	2	2	3	4	2	4

Booklet B

- Q31** More food made by the leaves above cut X, which cannot be transported downwards and was transported to the fruits above cut X.
- Q32a** Box R. Fungus appears in warm and damp places. Since Box R is warm and the shoe in Box R is damp, fungus will first appear in Box R.
- Q32b** It would allow the water vapour to escape, water to evaporate faster, thus keeping the ceiling dry and preventing growth of fungus.
- Q33a** As the temperature of the water increases, the length of the life cycle of the Aedes mosquito decreases.
- Q33b** May to August ✓
- Q33c** When there is more rainfall, there is more places for the mosquito to lay eggs/reproduce and become adults/to have mosquitoes.
- Q34a** (i) P is Carbon Dioxide
(ii) Q is Oxygen
- Q34b** The circulatory system transports blood to all parts of the body including the air sacs rich in oxygen and to some parts with carbon dioxide. The respiratory system performs gaseous exchange with carbon dioxide from the blood passing through the walls of blood vessels and into the surrounding. The oxygen will be taken in and will pass through the walls of the vessels and into the blood. The blood circulates it to all parts of the body.

- Q35** Blue. When blue light was shone at the beaker, the most amount of photosynthesis took place causing the most amount of oxygen to be collected. In order for the fish to breathe, it needs dissolved oxygen produced by water plants but for it to survive the longest period of time, blue light must be shone for the fish to take in more dissolved oxygen.
- Q35b** The webbed feet increases the surface area in contact with water so the turtle can push a larger amount of water to propel it forward.
- Q35c** The slimy substance acts as a lubricant and reduces friction between the snail's body and the ground so it is easier to move on the ground.
- Q36a** As the amount of carbon dioxide increases, the average global temperature increases.
- Q36b** When trees are planted again, it will photosynthesis and produce oxygen to the surroundings and take in carbon dioxide from the surroundings reducing the amount of carbon dioxide in the surroundings. When the amount of carbon dioxide decreases, it will trap lesser heat reducing the average global temperature over time.
- Q37a** (i) Temperature of surroundings
(ii) Amount of water in its habited
- Q37b** (i) H reduces friction between the body and the water causing it to overcome lesser water resistance helping it to move faster.
(ii) It traps moisture to keep it moist to reduce heat gain.
- Q37c** As the activity level of Animal K decreases during the hot and dry season, the lesser oxygen is taken in.
- Q38a** C. Good quality hair must be able to absorb moisture and retain it. C absorbs the most water and causes it to sink immediately due to its heavy weight.
- Q38b** How much hair is stretched.
- Q38c** Ensure that the amount of hair is the same.
Ensures that the amount of force is the same.
- Q39a** Cup: A
C
B
- Q39b** Glass C. It is not feasible for homes to have double-layered glass windows. Since the thick-layered glass is proven to be able to reduce heat loss compared to the thin-layered glass, glass C is the most suitable.

- Q39c** When the glass window becomes translucent, it reflects heat and light away, preventing heat gain into the house, which keeps the house cooler.
- Q40a** He could place one magnet on the outer surface of the fish tank and the other one on the inner surface. He could glide the magnet on the outside surface of the glass tank. The magnet inside will also act accordingly. If we move the magnet upwards, the one inside will move together with the algae. Through this process, we can clean off the algae.
- Q40b** Magnetism can pass through non-magnetic materials.
- Q41a** When the switch is closed, electricity passes through the circuit magnetising the steel. The steel will become an electromagnet attracting the iron on the spring. The striker attached to it will move down at the same time hitting the bell. We must open the switch, so the striker will only hit the bell once.
- Q41b** Once the switch is open, the electromagnet will not be able to attract the iron and the striker will not ring the bell.
- Q42a** Electrical → Kinetic → Kinetic + Heat + Sound
- Q42b** The shape of nose 1 is less streamlined causing it to overcome more air resistance so more electrical energy is used.
- Q42c** The sharp beak enables it to dive with a very small amount of pressure as it's surface area is small and sharp, allowing it to overcome air and water resistance.
- Q43a** 70°C
- Q43b** To ensure that it is a fair test because the temperature of water would be the same. The results will also be reliable and consistent.
- Q44a** As the height of the slope decreased, Ahmad possessed lesser potential energy and when it increased as he flew in the air, the potential energy he possessed was more and when he landed at points, he possessed the least potential energy.
- Q44b** It remained the same. Energy conversion was taking place but he did not lose it which is called energy efficiency. There was conversion taking place between kinetic and potential energy.

End