



RAFFLES GIRLS' PRIMARY SCHOOL

PRELIMINARY EXAMINATION
2017

Section A	56
Section B	44
Your score out of 100 marks	
Parent's signature	

Name : _____ Index No: _____ Class: P6 _____

25 Aug 2017

SCIENCE

Attn: 1h 45min

SECTION A (28 X 2 marks)

For each question from 1 to 30, four options are given. One of them is the correct answer. Make your choice (1, 2, 3 or 4). Shade the correct oval on the Optical Answer Sheet.

1. Organisms W, X, Y and Z are classified using the chart below.

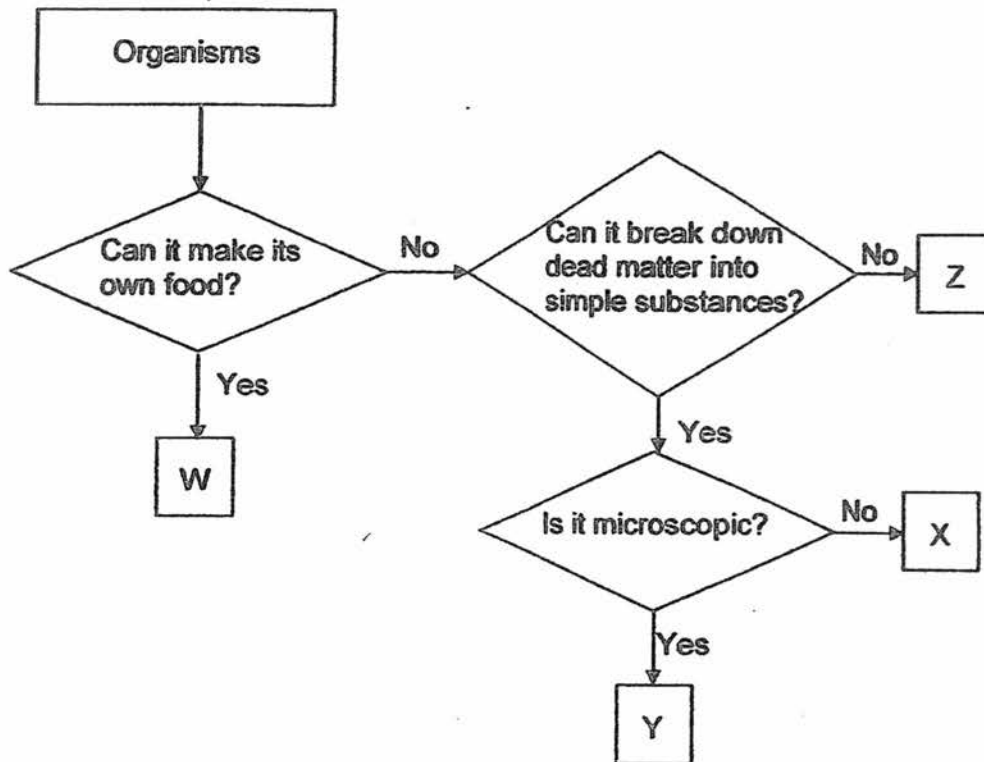

Which organism(s) is/are most likely to be a decomposer(s)?

- (1) Z only
- (2) W and X only
- (3) X and Y only
- (4) Z and Y only

2. Which of the following statements are true for both the fern and mushroom?

- A Fern and mushroom respire all the time.
- B Fern is able to make its own food but not the mushroom.
- C Both the fern and mushroom are non-flowering plants.
- D Fern reproduces from seeds and mushroom reproduces from spores.

- (1) A and B only
- (2) C and D only
- (3) A, B and C only
- (4) B, C and D only

3. The diagrams below show the life cycle of two animals, X and Y.



Life cycle of animal X

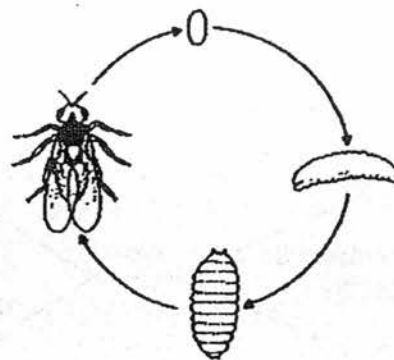

Life cycle of animal Y

Based on the diagrams above, which of the following statements is/are correct about the animals?

- A Both adult animals X and Y lay eggs.
- B The young of animal X resembles its adult.
- C Animal Y takes a longer time to complete its life cycle than animal X.

- (1) B only
- (2) A and B only
- (3) A and C only
- (4) A, B and C

4. Kaithyn carried out an investigation to find out the conditions required for seed germination. She prepared four set-ups, A, B, C and D. Each set-up contained eight seeds placed on a petri dish. She exposed the set-ups to different conditions.

She recorded her observations in the table below.

Set-up	Number of germinated seeds
A	8
B	8
C	0
D	0

Which of the following shows correctly the conditions that the set-up(s) was/were exposed to in order to obtain the results above?

Set-up	Conditions present (✓)		
	Warmth	Water	Light
A	✓		✓
B	✓	✓	
C	✓		✓
D		✓	✓

- (1) B only
 (2) A and B only
 (3) A, B and C only
 (4) B, C and D only
5. Which of the following is not a characteristic that is passed down from parents to their children?
- (1) hairstyle
 (2) eye colour
 (3) type of earlobe
 (4) ability to roll the tongue

6. Two seeds were sown in a container of soil and placed at the balcony. The soil was watered daily as shown in diagram A. Diagram B shows the observations made after a few weeks.

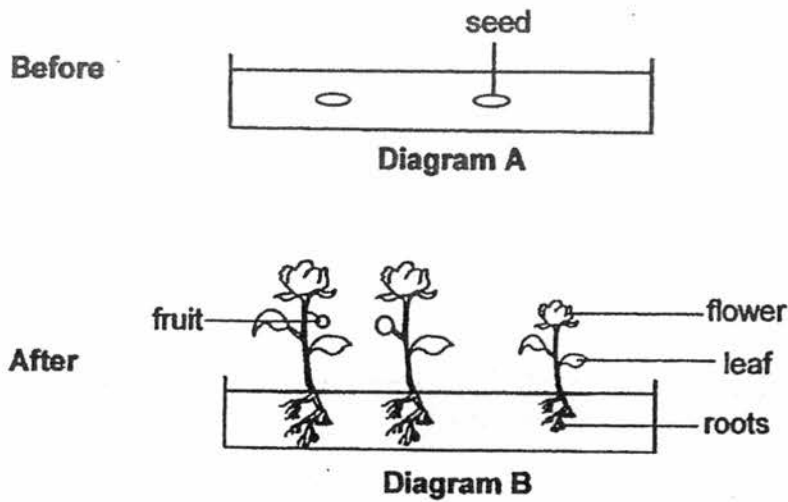

Based on the diagram above, which of the following process(es) have taken place?

- A fertilisation
- B germination
- C pollination
- D seed dispersal

- (1) A and B only
- (2) B and C only
- (3) A, B and C only
- (4) A, B, C and D

7. Which of the following human body systems work together to enable one to run?

- A digestive
- B muscular
- C skeletal
- D reproductive

- (1) A and B only
- (2) A, B and C only
- (3) B, C and D only
- (4) A, B, C and D

8. Ali split the stalk of a white flower and placed both ends into two different containers of coloured water as shown below.

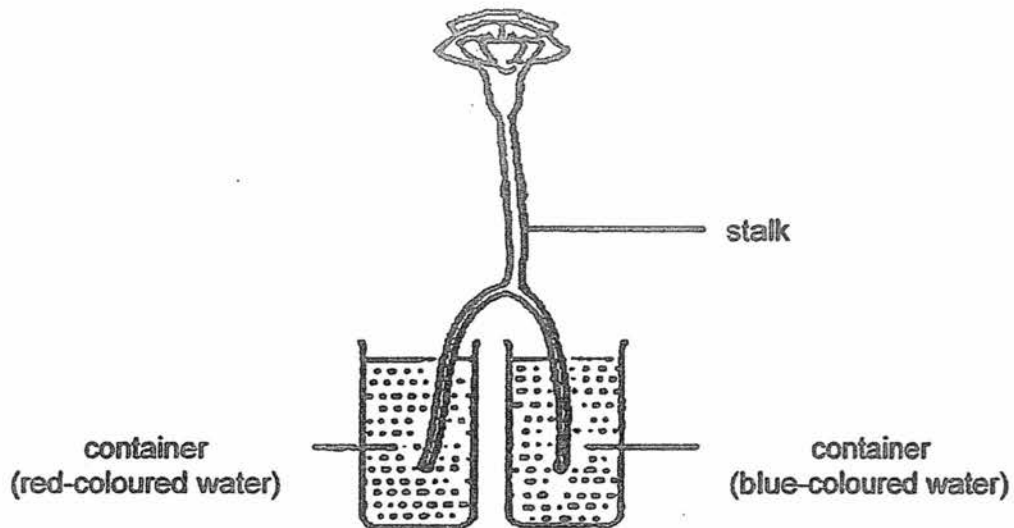

After one day, Ali observed that there was a change in the colour of the flower. Based on the given information, which of the following statement(s) is/are true?

- A The white flower had turned partially blue and red.
 - B The plant could not take in the coloured water as it had no roots.
 - C The food-carrying tubes transport the coloured water to the flower.
 - D The water-carrying tubes transported the coloured water to the flower.
- (1) D only
(2) A and B only
(3) A and D only
(4) B and C only

9. The diagrams below show two different cells, A and B, from the same plant.

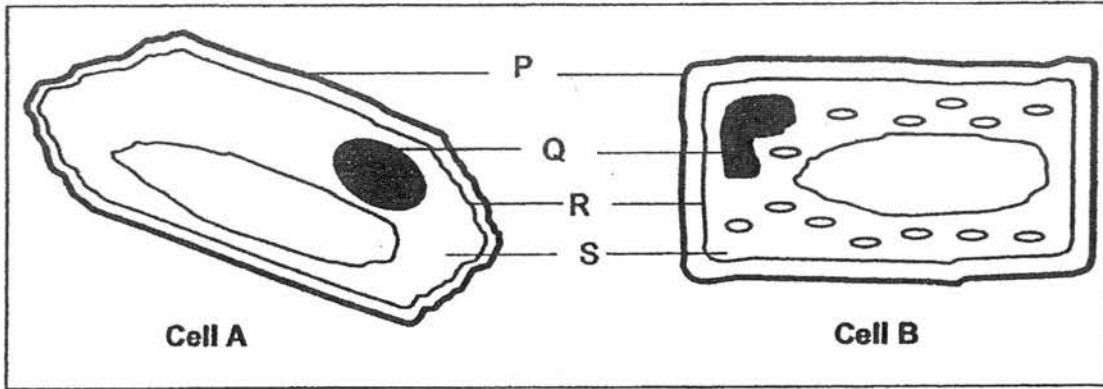

Which part of the cell, P, Q, R or S, allows substances to move around within the cell?

- (1) P
- (2) Q
- (3) R
- (4) S

10. Peter wanted to investigate how the amount of water affects the growth of plants. He prepared four set-ups, A, B, C and D, as shown below and placed them in the same location.

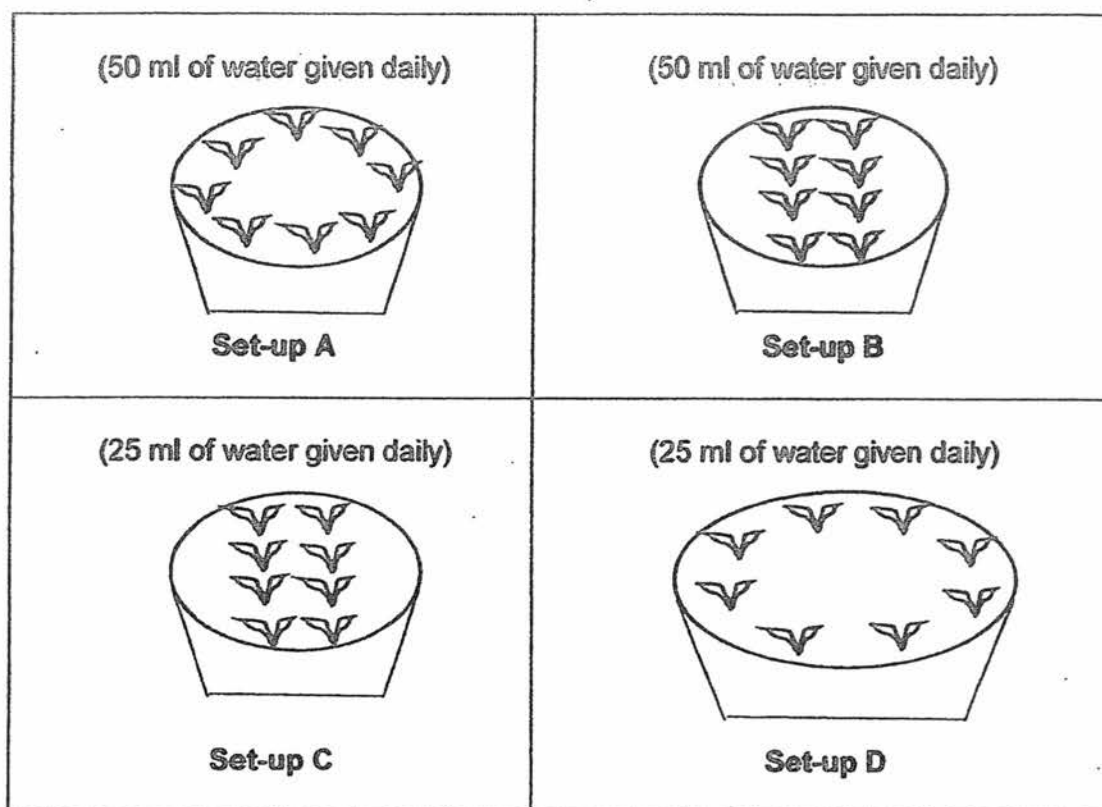

Which of the set-ups, A, B, C and D, should he use to compare so as to ensure a fair test?

- (1) A and C only
- (2) A and D only
- (3) B and C only
- (4) B and D only

11. Peter wanted to conduct an experiment to investigate the effect of substance X in keeping snakes away from his house. He marked a rectangular area on the ground and sprinkled 100g of substance X along its perimeter. Then a fence was placed around the rectangular area. He placed a snake within the fenced area as shown below and observed if it crossed the substance X and entered the rectangular area.

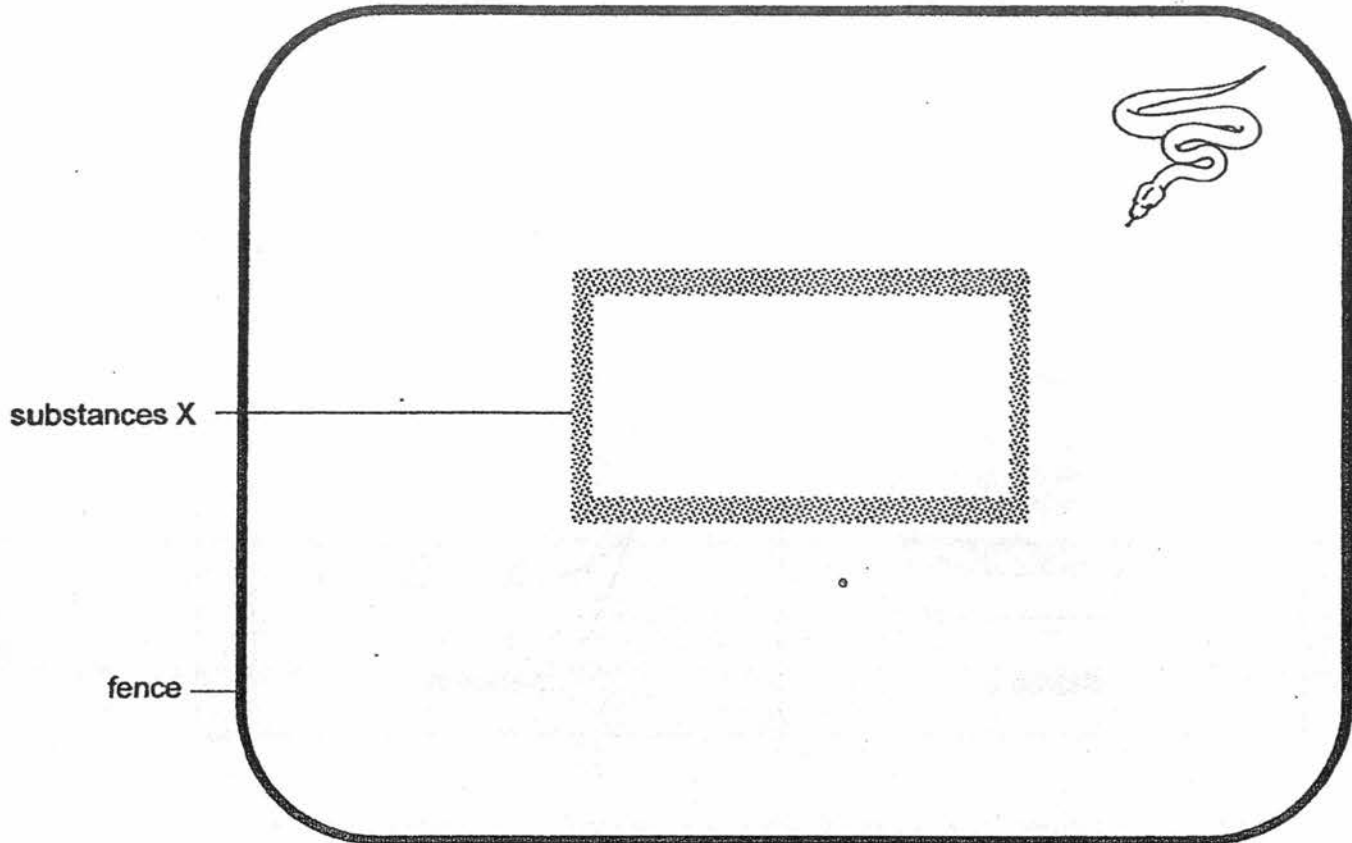

How much substance X should he use in his control set-up?

- (1) 0 g
- (2) 50 g
- (3) 100 g
- (4) 150 g

12. The table below shows the relationship among five organisms in a community.

Q feeds on S
 S feeds on R and T
 P provides food for T and R

Which one of the following classified the roles of the organisms in the community correctly?

	Producer	Prey only	Prey and Predator	Predator only
(1)	P	R	S and T	Q
(2)	P	R and T	S	Q
(3)	R	P	Q	S and T
(4)	T	P and Q	S	R

13. The graph below shows how the number of organism P changed over a period of four weeks.

No. of organism P

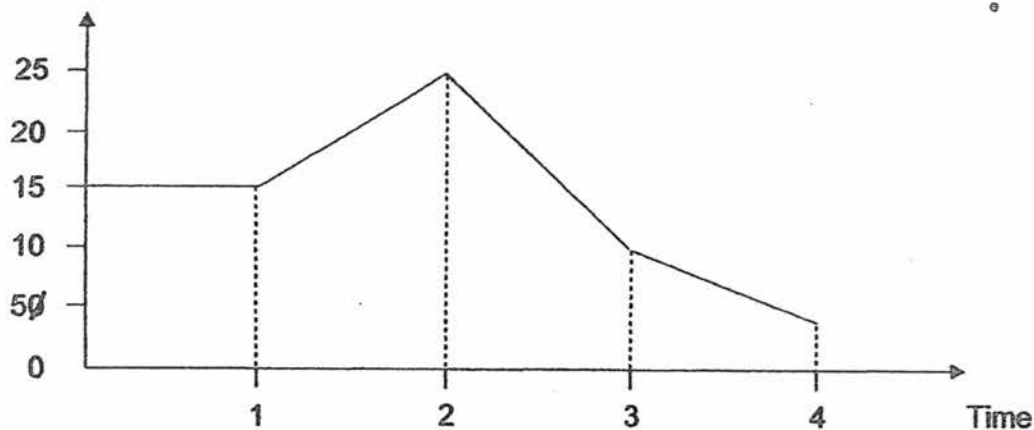

Based on the graph above, which of the following statement(s) is/are definitely true?

- A Population P would all die eventually after week 4.
 - B The highest number of P was recorded in week 2.
 - C The population of P remained constant in the first week.
 - D Between week one and three, population P increased more than it decreased.
- (1) D only
 (2) A and D only
 (3) B and C only
 (4) A, B and C only

14. The diagram below shows the feet of four animals.

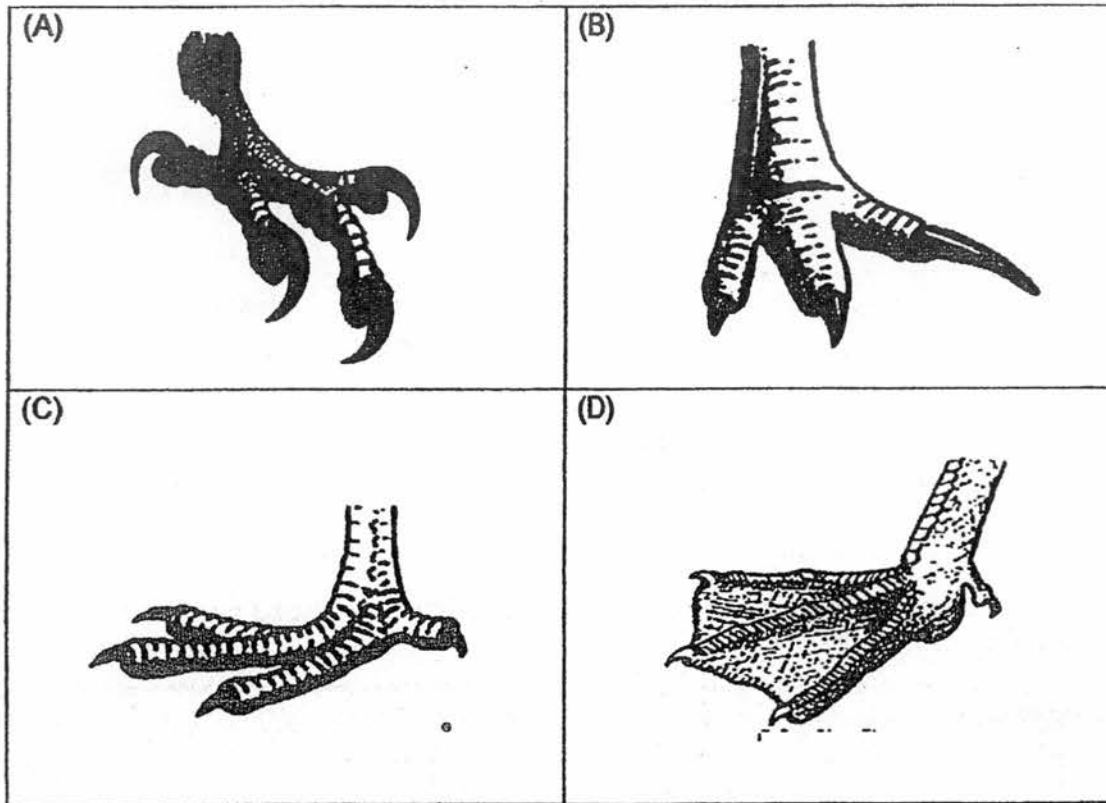

Which one of the following correctly matches the function of the feet?

	Running	Swimming	Grasping	Scratching
(1)	A	C	B	D
(2)	B	D	A	C
(3)	C	B	D	A
(4)	D	A	C	B

- 15 The factories discharge harmful waste into point Y of the river. The harmful waste kills many of the aquatic organisms. The river is also the main source of water for the villagers. The arrow shows the direction in which the river flows.

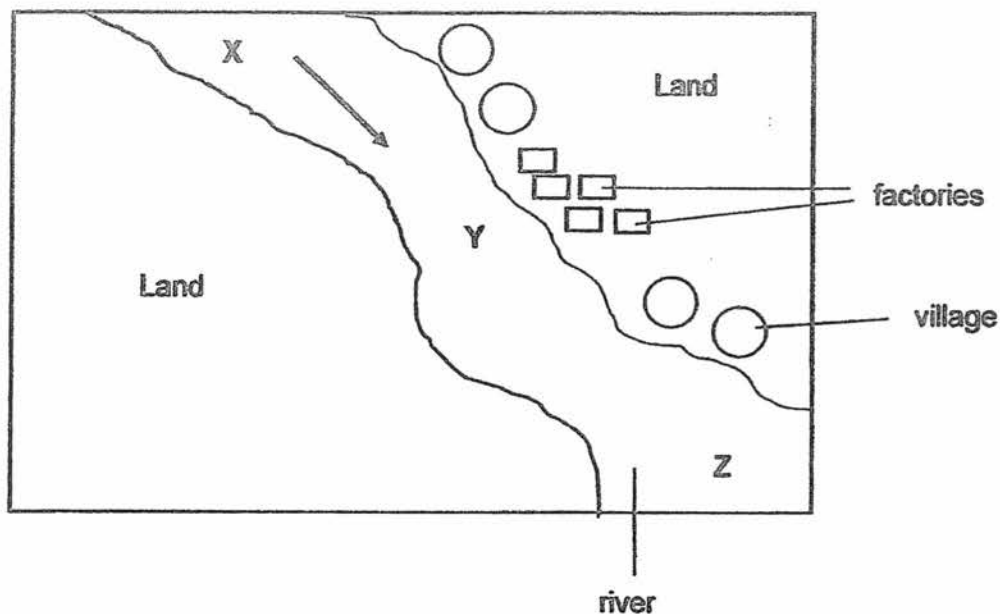

Which of the following statement(s) most likely describe(s) the harmful effect(s) of waste discharged in the river?

- A There will be less organisms living at point Y than point X in the river.
 - B The water from the river is safe for drinking for the villager between point Y and Z.
 - C There is an increase in the amount of carbon dioxide between point Y and Z in the river.
- (1) A and B only
(2) A and C only
(3) B and C only
(4) A, B and C

16. Kelvin set up two identical set-ups in a dark room as shown below. He added two water snails in set-up B.

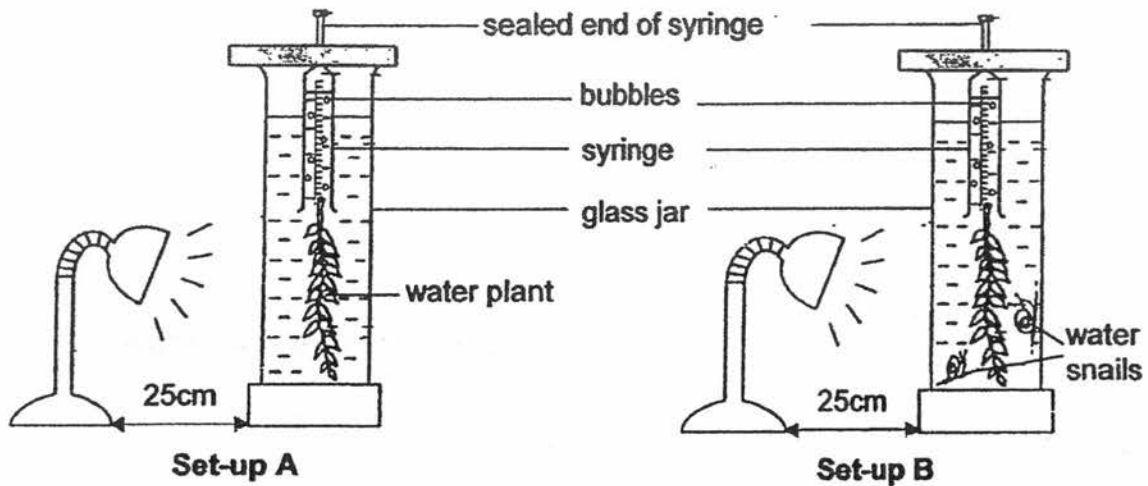

He placed both the table lamps at a distance of 25 cm from the glass jars. After one hour, the syringes in both set-ups collected some gas.

Which one of the following most likely shows the volume of gas collected in each of the set-ups?

	Volume of gas collected in set-up A (cm ³)	Volume of gas collected in set-up B (cm ³)
(1)	5	4
(2)	5	5
(3)	5	7
(4)	7	5

17. Jack wanted to find out which rod, P or Q, would be more suitable to hang heavy weights. He clamped rod P on a retort stand and hang a 15-kg weight on it as shown below.

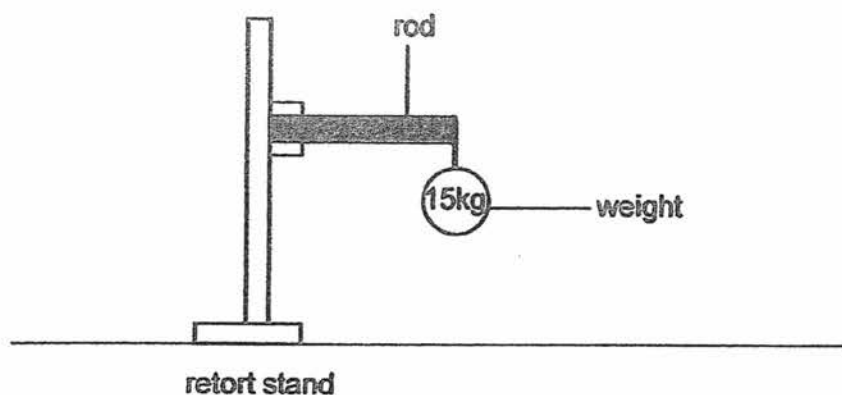

He repeated the experiment by replacing rod P with rod Q. He observed that rod Q broke but not rod P.

Based on the information above, which one of the following statements is correct?

- (1) Rod P is stronger as it could withstand weights of up to 15kg.
- (2) Rod Q is stronger as it could withstand weights of more than 15kg.
- (3) Rod P is more flexible as it could withstand weights of up to 15 kg.
- (4) Rod Q is more flexible as it could withstand weights of more than 15 kg.

18. Leonard measured the mass of a sealed packet of sweets using an electronic balance as shown below.

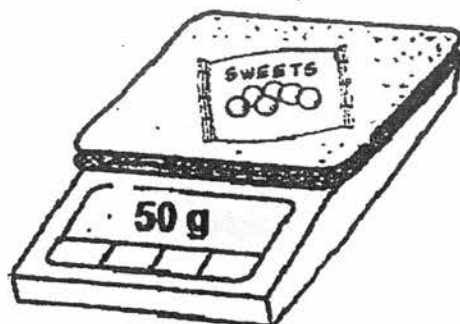

He recorded the results as shown below.

Mass of a sealed packet of sweets = 50 g
Mass of one sweet = 1 g

He expected to find 50 sweets in the sealed packet. However, he found that there were only 48 sweets in the sealed packet.

Which of the following is/are likely to be the reason(s) for not having 50 sweets in the packet?

- A The wrapper has mass.
- B Air in the wrapper has mass.
- C The wrapper has a definite shape.
- D Air in the wrapper has no definite volume.

- (1) A only
- (2) A and B only
- (3) B and D only
- (4) A, B, C and D only

19. Tricia placed a solid made of substances Q, R and S in the set-up as shown below. Substances Q and R had higher melting points than substance S.

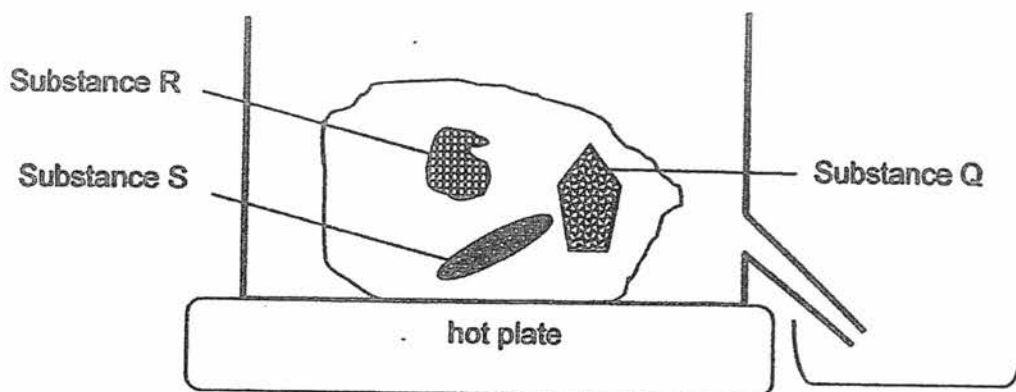

She wanted to ensure that the solid does not contain substance S.

What temperature should she set the heater?

- (1) Above melting points of Q, R and S.
- (2) Below melting points of Q, R and S.
- (3) Above melting points of Q and R but below melting point of S.
- (4) Above melting point of S but below melting points of Q and R.

20. Sarah wanted to find out if the exposed surface area of water has an effect on the rate of evaporation of water in the container. The diagram below shows four containers A, B, C and D containing water.

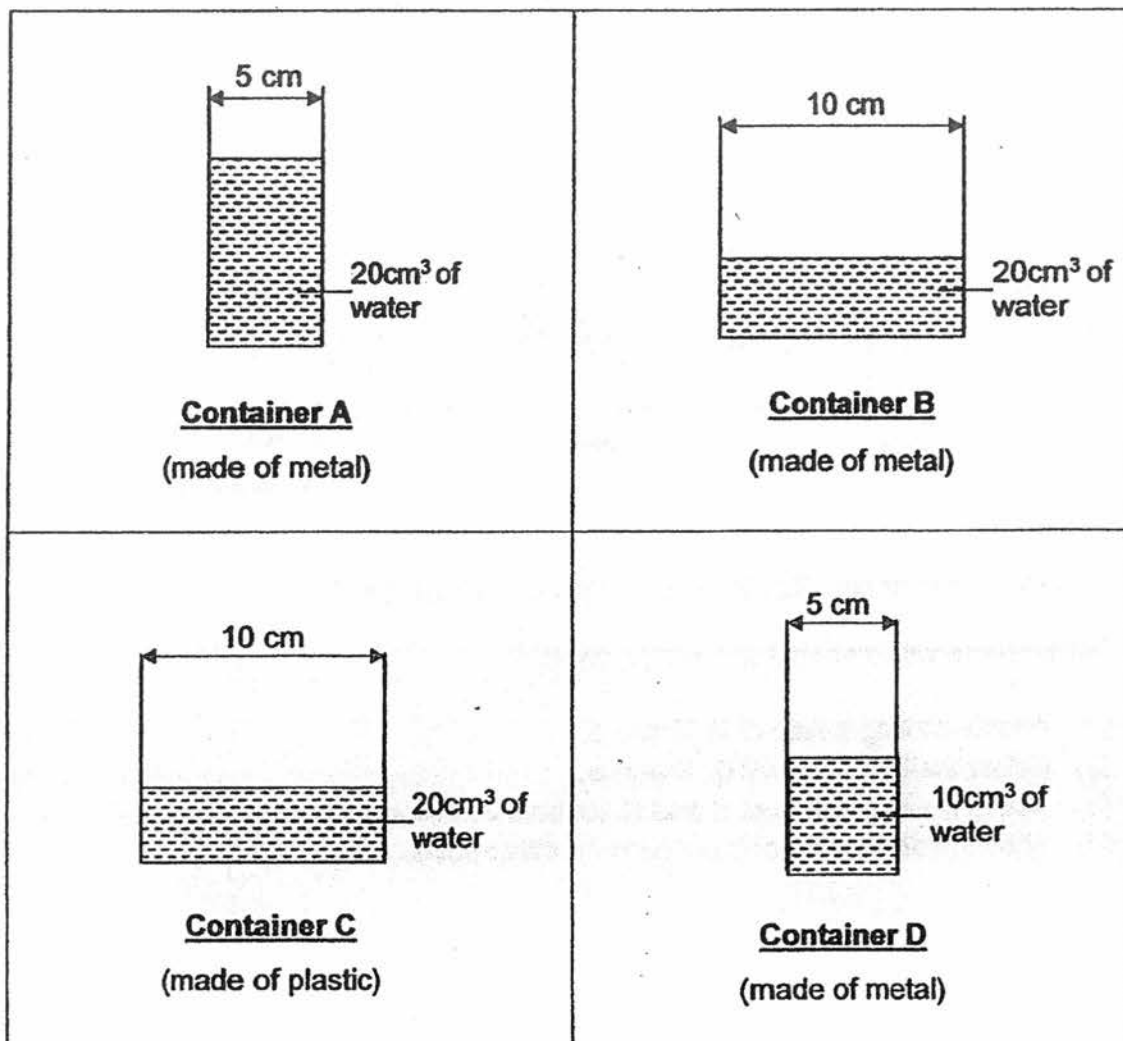

In order to ensure that her experiment is a fair test, which containers should Sarah choose for her experiment?

- (1) A and B only
- (2) A and D only
- (3) B and C only
- (4) C and D only

21. A circuit diagram is as shown below.

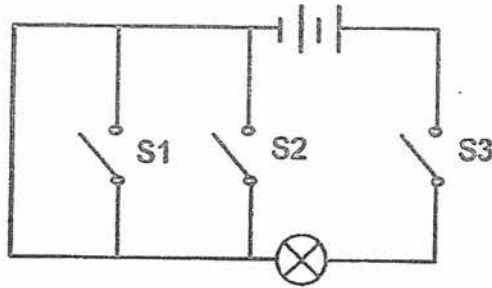

What is the minimum number of switch(es) that need(s) to be closed for the bulb to light up?

- (1) 0
- (2) 1
- (3) 2
- (4) 3

22. The set-up below is made up of four rings, W, X, Y and Z.

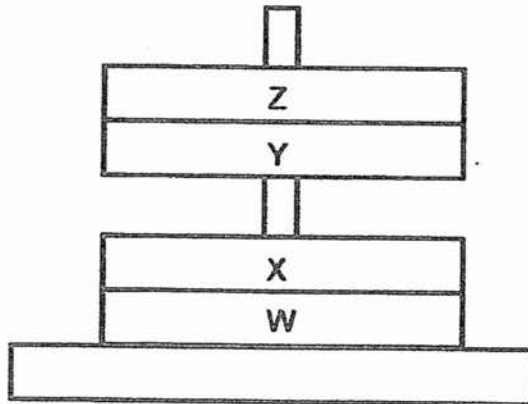

Based on the information above, which of the following are possible materials for W, X, Y and Z.

	W	X	Y	Z
A	magnet	steel	magnet	steel
B	magnet	iron	magnet	magnet
C	iron	magnet	magnet	plastic
D	steel	plastic	iron	magnet

- (1) C only
- (2) B and C only
- (3) A and D only
- (4) A, B and D only

23. Sheila wanted to find out the electrical conductivity of 3 rods, A, B and C, made of different materials. She inserted the rods into the circuit at position X, Y and Z as shown below.

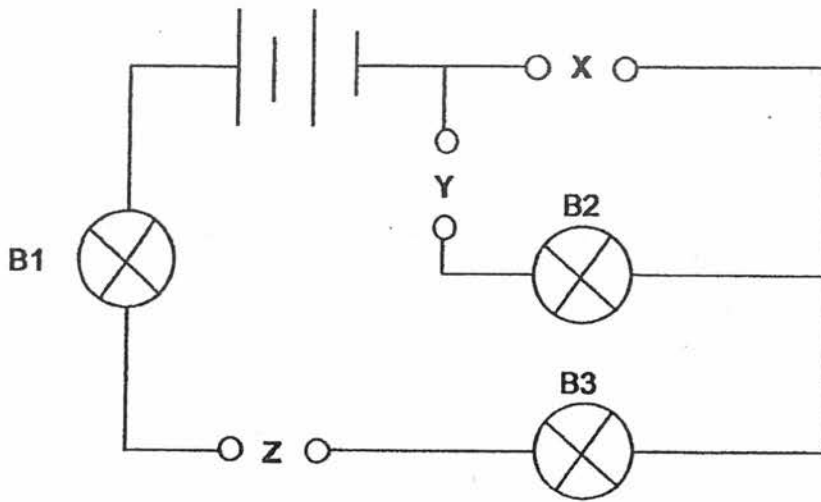

The table below shows the results collected at the end of the experiment.

Positions where rods were placed			Did the bulb light up?		
X	Y	Z	B1	B2	B3
A	B	C	✓	✓	✓
B	C	A			
C	A	B	✓		✓

Based on the data above, which one of the following conclusions is correct?

- (1) Only rod A is a non-conductor of electricity.
- (2) Only rod C is a non-conductor of electricity.
- (3) Only rods B and C are non-conductors electricity.
- (4) Rods A and B are better conductors of electricity than rod C.

24. Helen dropped two balls, X and Y, of the same size but of different mass into a tray of flour from the same height as shown below.

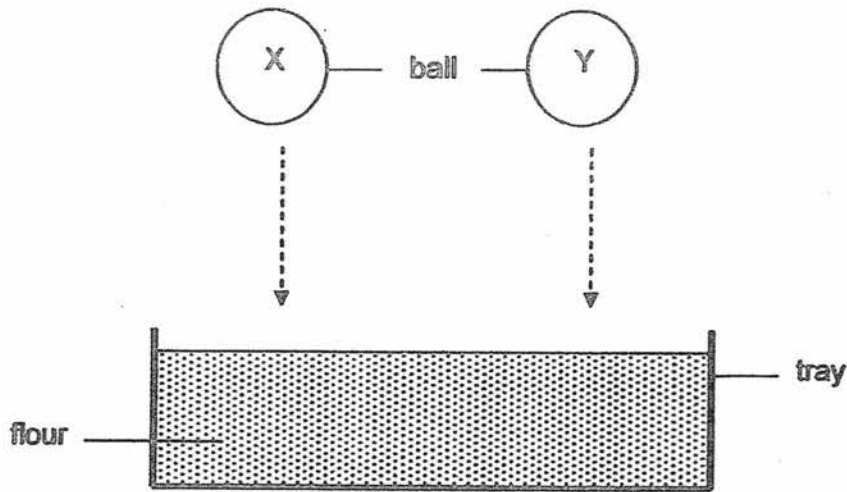

She recorded the depth of the dent made by each ball in the tray of flour in the table below.

Ball	Depth of dent (cm)			
	1 st try	2 nd try	3 rd try	Average
X	1	1.5	1	1.17
Y	3	3.5	3.5	3.33

Based on the results in the table above, which one of the following statements correctly explains her observations?

- (1) More frictional force was acting on X than Y.
- (2) More frictional force was acting on Y than X.
- (3) More amount of gravitational force was acting on X than Y.
- (4) More amount of gravitational force was acting on Y than X.

25. Tim kicked a ball into the air and it travelled in the path as shown below before rolling to a stop.

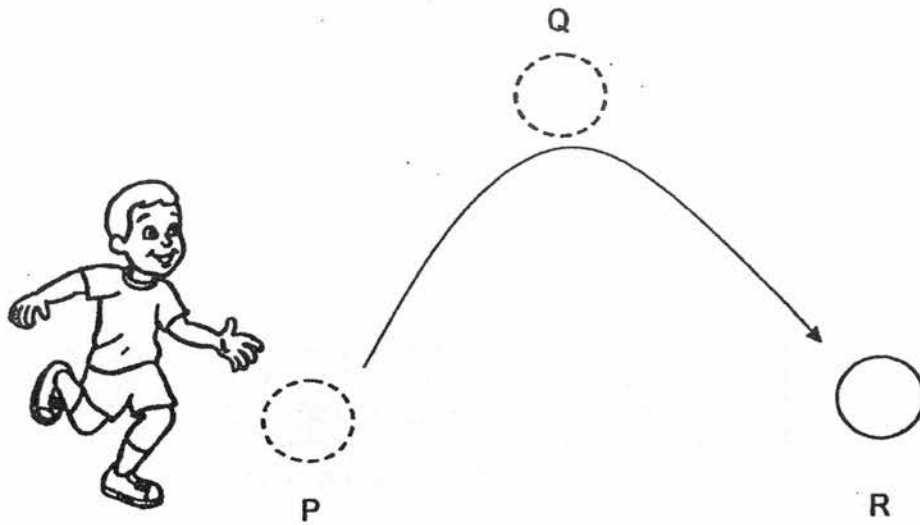

Which one of the following statements is correct?

- (1) Gravity acted on the ball only when it travelled from Q to R.
- (2) There are no other forces acting on the ball from P to Q except gravity.
- (3) The amount of gravity acting on the ball when it travelled from P to R is the same.
- (4) The amount of gravity acting on the ball decreased when the ball travelled from P to Q and increased when it dropped from Q to R.

26. The set-up below uses a light sensor to count the number of identical wooden boxes X on a moving belt.

To speed up the counting process, two boxes are stacked on top of each other.

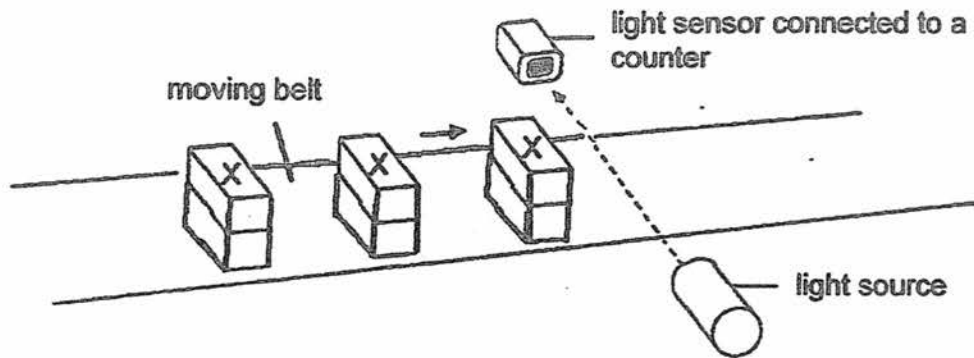

The data obtained is shown in the graph below.

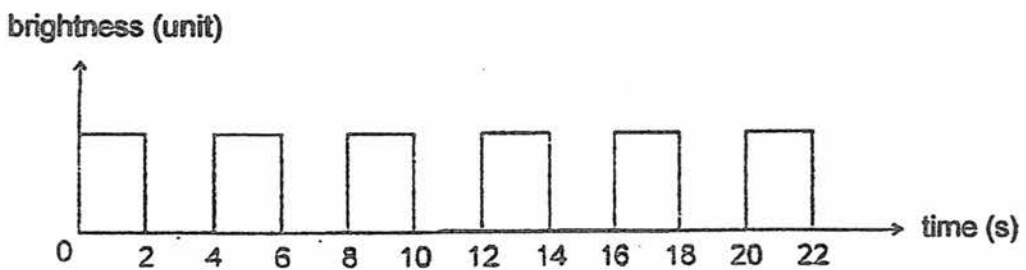

Based on the graph, how many boxes were counted in 22 seconds?

- (1) 5
- (2) 6
- (3) 10
- (4) 12

27. Adding salt to water can increase the boiling point and decrease the freezing point of water. James used the set-up below to make his own ice cream.

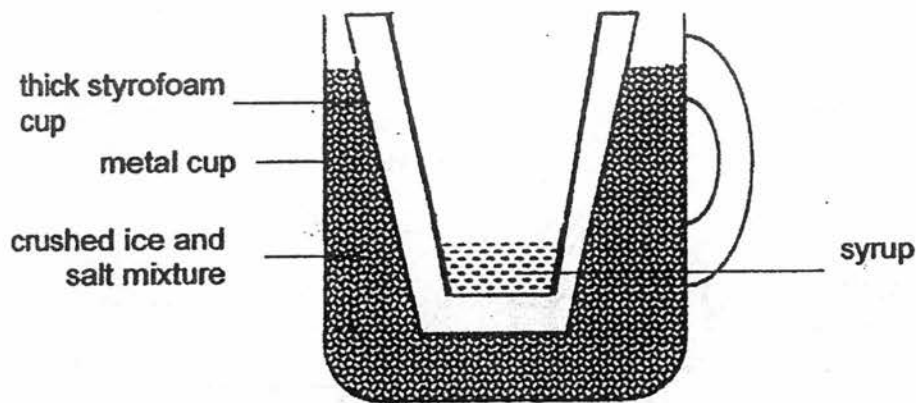

What would James observe after three minutes?

- A The syrup would be frozen.
 - B The syrup would not freeze.
 - C A thin layer of ice would form on the outer surface of the metal cup.
- (1) A only
(2) B only
(3) A and C only
(4) B and C only

28. The water garden feature below is solar-powered. The solar panel which absorbs energy from the sun is connected to a motor in the bowl. The motor pumps water up into the jug through the water pipe. Then the water flows down to the bowls.

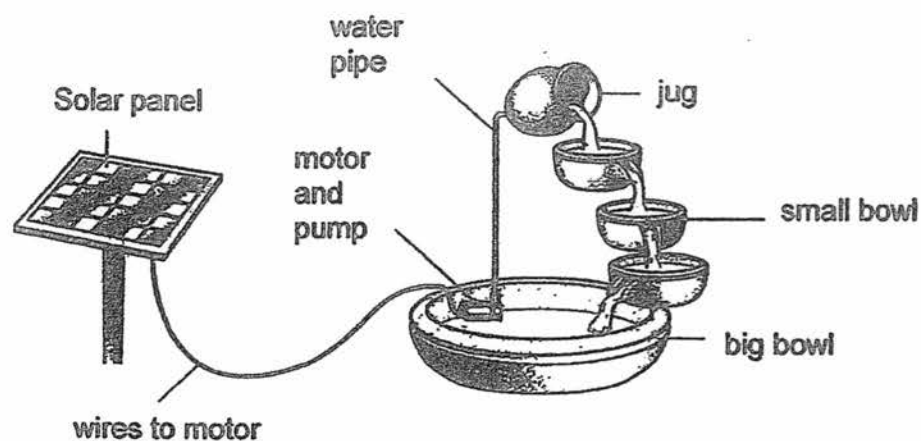

Which one of the following is true of the garden feature above?

- (1) The garden feature cannot operate when there is no heat.
- (2) The water in the big bowl has more potential energy than the water in the jug.
- (3) The water flowing out of the jug has both potential energy and kinetic energy.
- (4) Heat energy is converted to potential energy and kinetic energy for the feature to work.

SECTION B (44 marks)

For questions 29 to 41, write your answers clearly in the spaces provided.

The number of marks available is shown in the brackets [] at the end of each question or part question.

29. Study the flow chart as shown below.

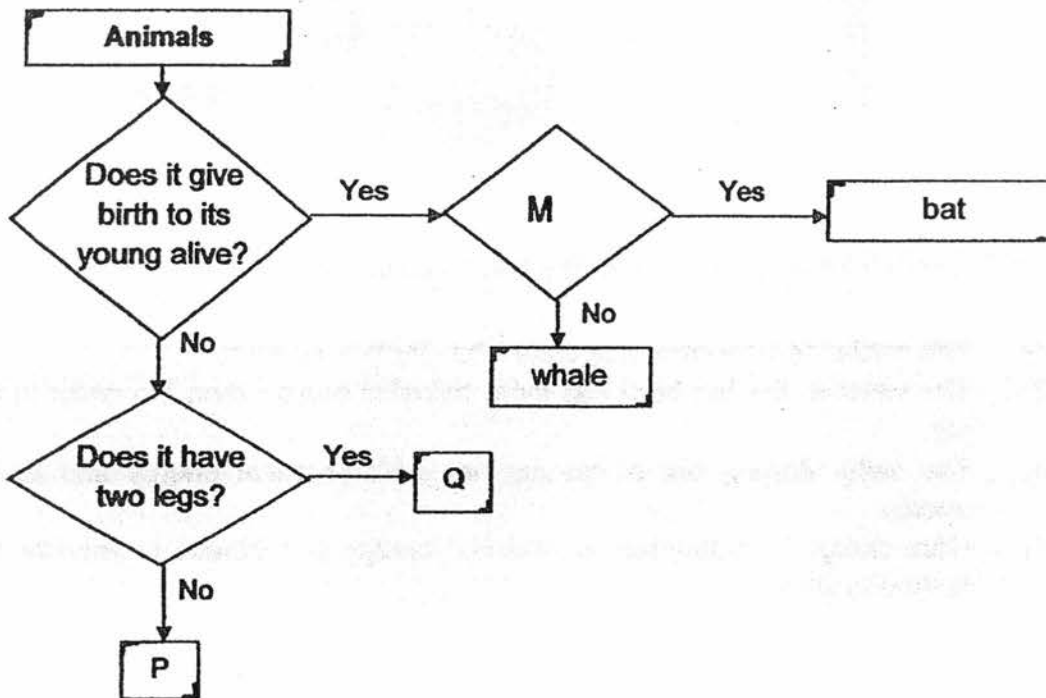

Based on the information above, answer the following questions:

(a) What does 'M' represent? [1]

(b) State one similarity and one difference between animals P and Q. [2]

Similarity: _____

Difference: _____

Score	3
-------	---

30. The diagrams below show the cross-sections of flowers A and B.

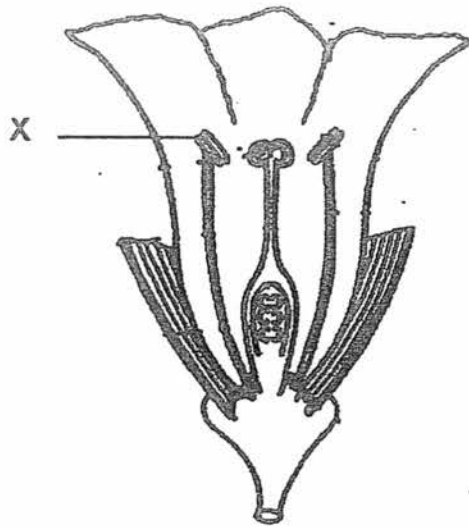

Flower A

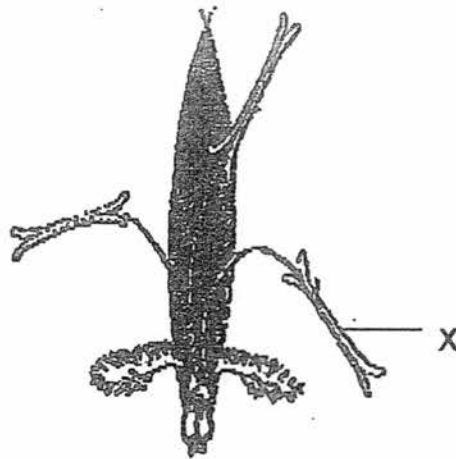

Flower B

(a) State the function of part X. [1]

(b) Based on the diagrams above, state how each flower is pollinated and give a reason for your answer. [2]

(i) Flower A : By _____

Reason : _____

(ii) Flower B : By _____

Reason : _____

Score	3
-------	---

31. It was observed that the top layer of the soil is usually washed away by heavy rain. An experiment was conducted to find out which plant, A, B or C, with different kinds of root systems, is most suitable to be planted on hilly regions to hold the soil together.

The diagram below shows how the horizontal distance and the depth of root growth are measured.

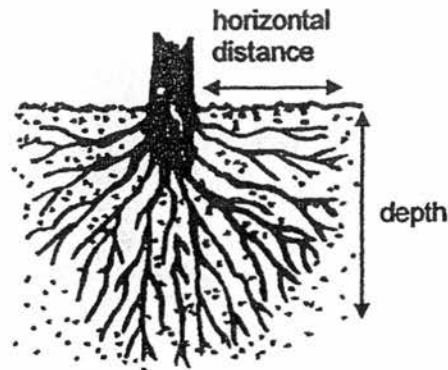

The depth and the horizontal distances of the roots growth of plant A, B and C were measured and tabulated in the table below.

Plant	Number of roots	Depth of root growth (m)	Average horizontal distance of root growth from plant (m)
A	10	2.8	1.4
B	15	1.3	5.1
C	15	2.2	8.7

- (a) Which plant, A, B or C, is most suitable to be planted on the hill slope to hold the soil together? Explain your answer clearly. [2]

Continue on next page

Score	2
-------	---

Continued from previous page

It was observed that when another plant D was planted in non-fertile soil, the leaves of the plant remained green and did not wilt.

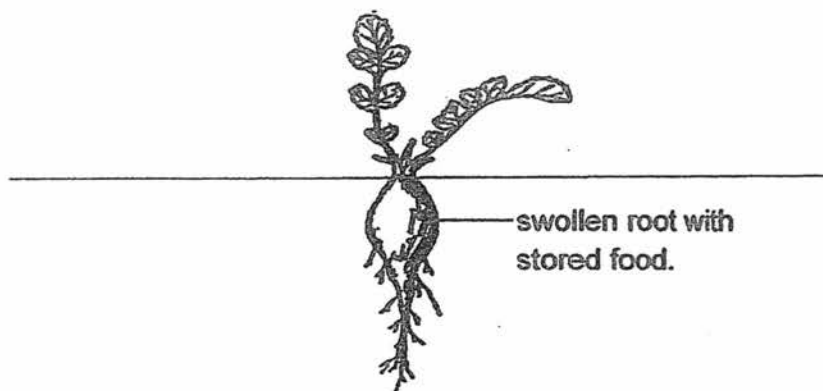

Plant D

- (b) Based on the information above, state the change to be observed in the swollen root with stored food after a week. Give a reason for your answer. [1]

Score	1
-------	---

32. The diagram below shows the transfer of poison in a food web from organisms W to organisms Z. Organisms W, X, Y and Z lived in the same community.

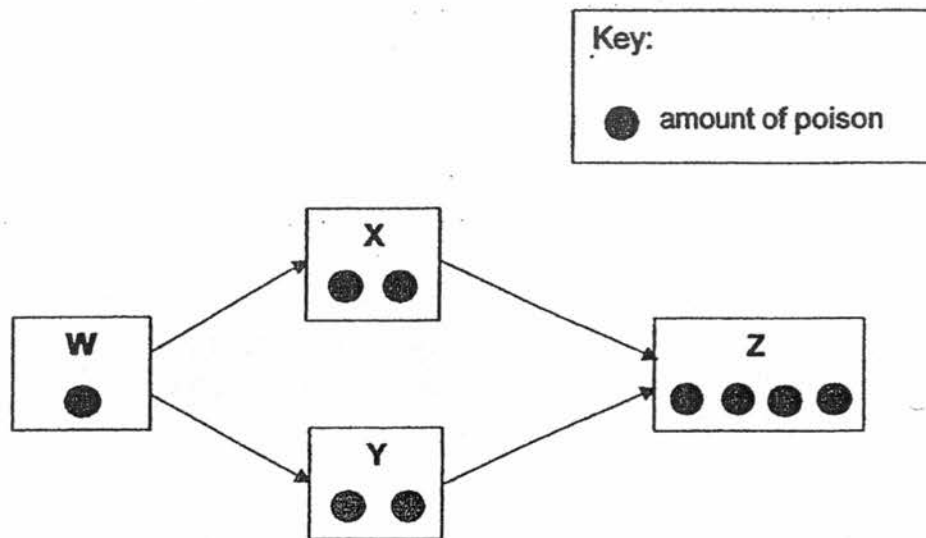

- (a) Based on the information above, identify the food producer and predator. [1]

Food producer: _____

Predator : _____

- (b) If organisms W decreased, explain what would happen to the number of organisms Z. [2]

- (c) Explain why organisms Z accumulated the greatest amount of poison in their bodies. [1]

Score	4
-------	---

33. The table below shows some information about animal X.

Habitat	<ul style="list-style-type: none">◦ Dry and hot.◦ Water is scarce.◦ Has low growing plants and shrubs throughout the year.◦ Digs burrows to sleep at night to conserve body heat.
Diet	<ul style="list-style-type: none">◦ Feeds mainly on low-growing plants and shrubs, such as the cactus◦ Supplements its diet with insects.◦ During rainy season, drinks water from pools of water.
Movement	<ul style="list-style-type: none">◦ Moves very slowly.
Other facts	<ul style="list-style-type: none">◦ Has ticks (parasites) on its body which can spread disease.◦ Has no structural adaptations to store water.◦ Its predators are dogs, cats and predatory birds.

Based on the information given in the table above, answer the following questions:

- (a) Animal X needs to drink sufficient water daily. When water is scarce during the drier periods, how does animal X get its supply of water? [1]

- (b) At night, animal X sleeps in burrows to conserve its body heat. Give another reason why it sleeps in burrows at night. [1]

- (c) Bird Y feeds on ticks. Explain how bird Y and animal X benefit each other from this. [1]

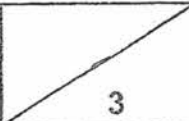
Score	
-------	---

2017 P6 Science Prelim

34. Paul took a jar of jam from the refrigerator. He tried to open it but was unsuccessful.

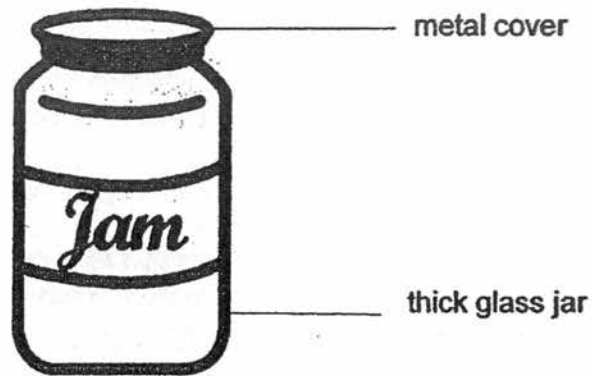

His mother told him to turn the jar over and dip the cover of the jam into a basin of hot water for fifteen seconds. After that, he was able to open the cover.

- (a) Explain clearly why Paul was able to open the cover of the jam jar. [2]

Paul decided to reuse the jam jar. He submerged the empty jar into a basin of ice and poured boiling water into it as shown below.

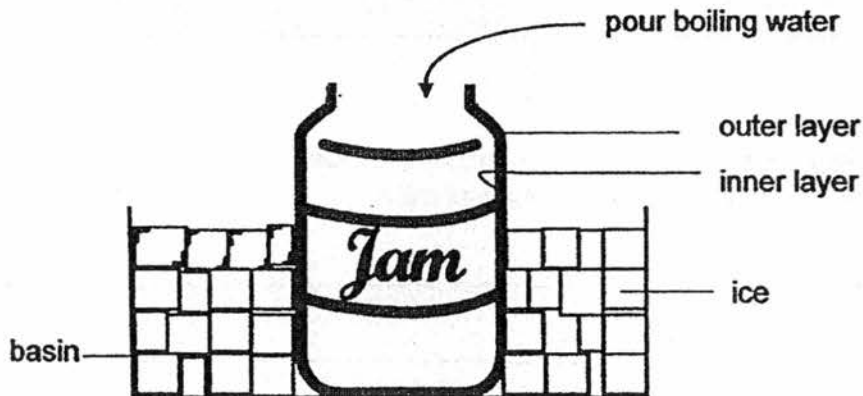

- (b) He noticed that the jar started to crack. Explain his observation clearly. [2]

Score	4
-------	---

35. The device below is used in some countries to obtain pure drinking water from the surrounding air. The solar panel which is attached to the fan, powers the fan. Air from the surrounding will be drawn underground through the underground slanted pipes when the fan rotates. Pure drinking water obtained by this method could be pumped above the ground with the help of the pump attached.

Buried pipe to obtain pure drinking water

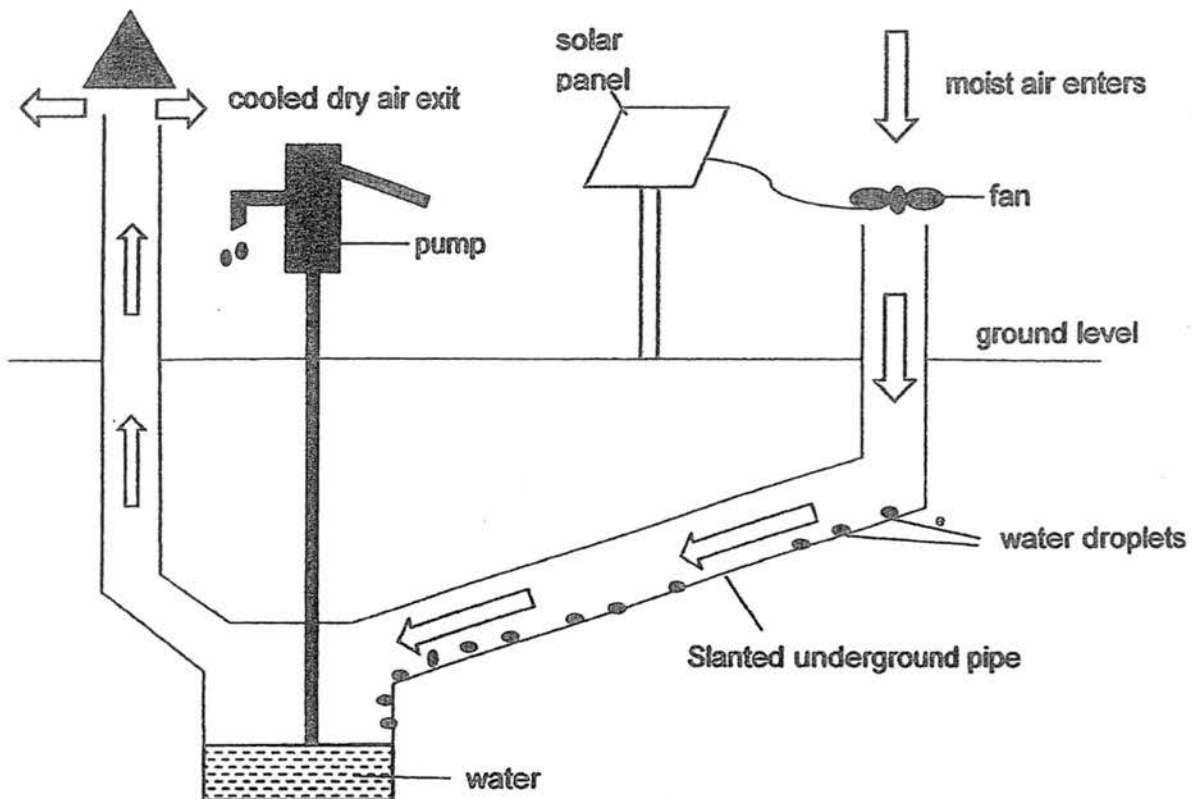

- (a) The temperature of air above the ground ranges from 18°C to 46°C while the temperature underground ranges from 7°C to 18°C . Explain how water can be obtained from the air that passes through the pipes. [2]

- (b) One way to collect more water using this device is to pass more air through the inlet. Suggest two other changes to the device that would enable it to collect more water over a fixed period of time. [2]

Score	4
-------	---

36 Study the following set-up carefully.

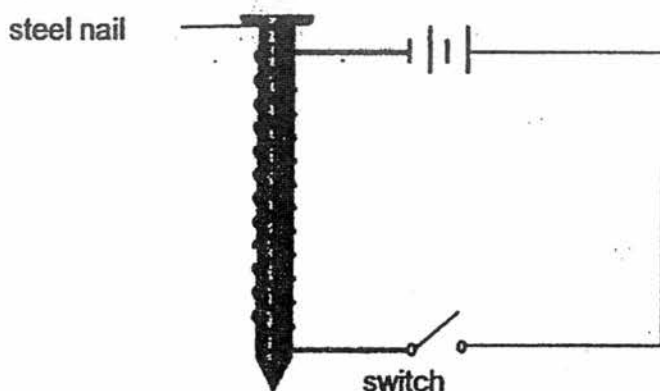

(a) Explain what will happen when the switch is closed. [1]

Many doors in schools such as the science labs and the computer labs are fitted with an electromagnet as shown in the diagram below to ensure that the doors remain closed.

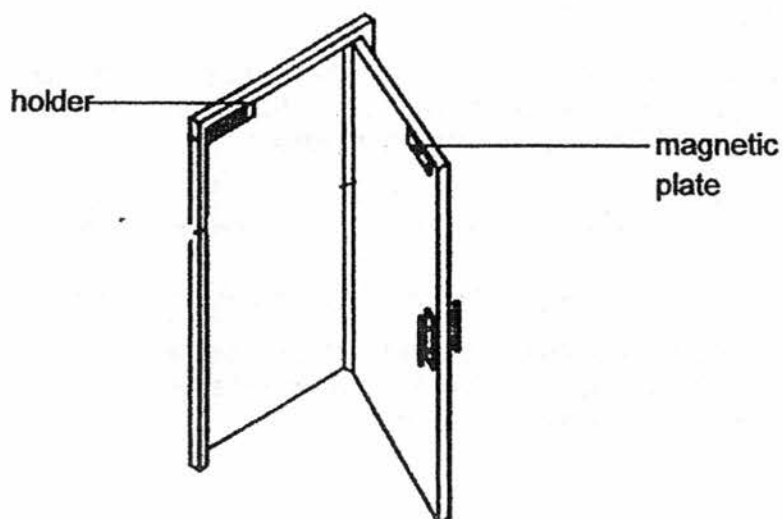

Continue on next page

Score	1
-------	---

Score	2
-------	---

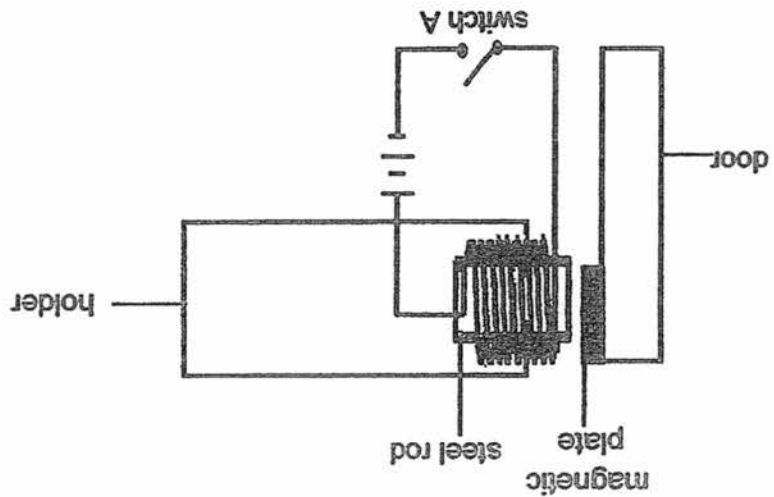

(b) Explain clearly why when switch A is closed, the door will be locked. [2]



The diagram below shows the circuit and the electromagnetic lock.

Continued from previous page

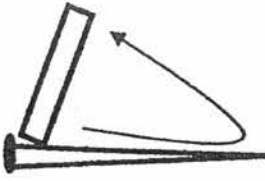
37. The table below shows action(s) which involve(s) push(es) and/or pull(s). Classify the actions by putting a tick (✓) in the correct column below.

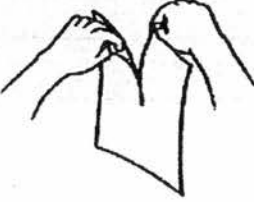
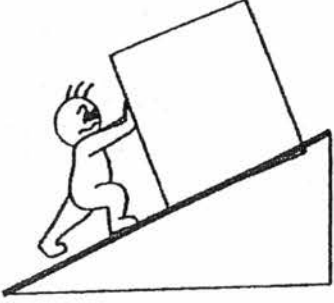
S/N	Actions	Image	Push	Pull
1.	Stroking an iron nail with a magnet.			
2.	Wiping the table with a cloth.			
3.	Tearing a piece of paper.			
4.	Moving the box up the ramp.			

Score	4
-------	---

38. Ann wanted to find out how the type of ramp affects the amount of frictional force acting on the object moving down the ramp. She used ramps X, Y and Z made of different materials.

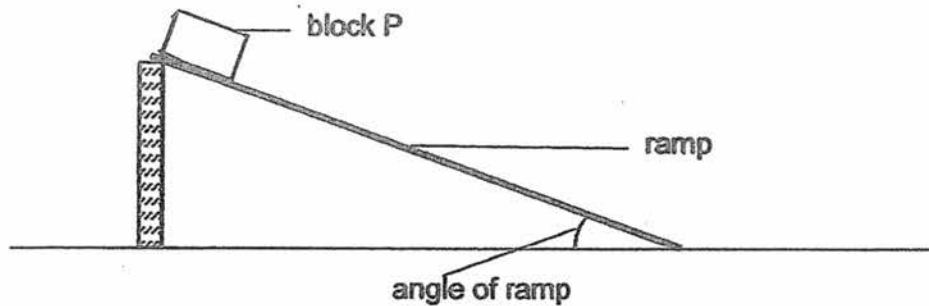

She put block P on ramp X and increased the angle of the ramp until the block started to slide down the ramp. She repeated the experiment by using ramp Y and Z. She recorded her results in the table below.

Ramp	Angle of ramp ($^{\circ}$)
X	40
Y	50
Z	60

- (a) On the diagram above, draw an (\rightarrow) to indicate where the frictional force was acting on the sliding block P. [1]
- (b) On which ramps, X, Y or Z, would there be the least amount of frictional force acting on block P? Give a reason for your answer. [1]

Continued on next page

Score	2
-------	---

Continued from previous page

Ann decided to slide block W, which is bigger than block P, down ramp X. Block W was made of the same material as block P and had identical mass as block P.

She observed that block W, like block P, started to slide down the ramp when the angle of ramp was 40° .

Block	Mass (g)	Area of contact surface (cm ²)	Angle of ramp (°)
P	100	100	40
W	100	150	40

- (c) Based on the information above, did the area of contact of the block with the ramp affect the amount of frictional force acting on the blocks? Give a reason for your answer. [1]

Score	1
-------	---

39. Sarah wanted to find out the type of shadows formed when light was shone at different materials. She prepared set-ups A and B using identical bulbs and rods made of different materials. She placed the two set-ups in the garden as shown below.

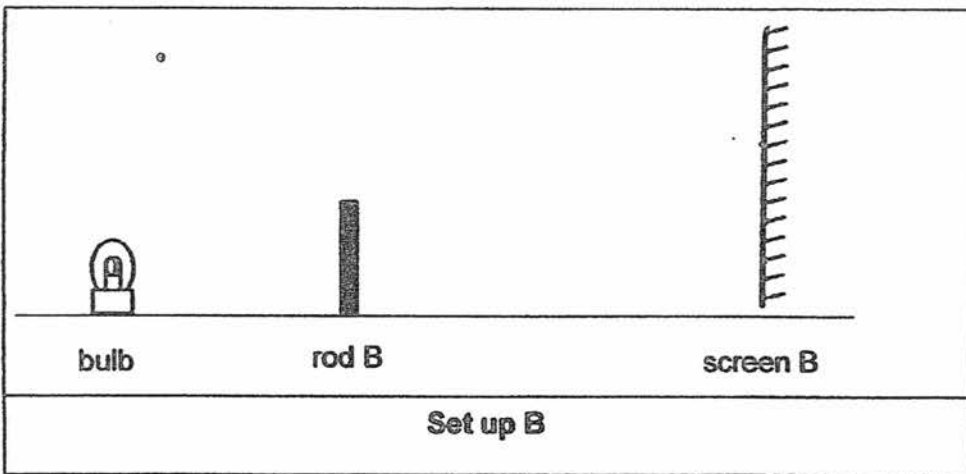
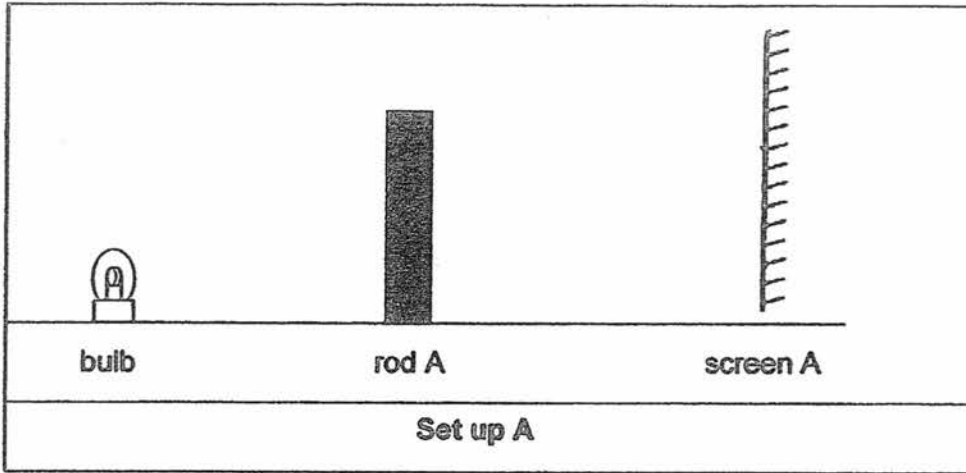

(a) Her classmate told her that she needed to carry out her experiment in a dark room to ensure a fair test. Do you agree? Give a reason for your answer. [1]

Continue on next page

Score	1
-------	---

Continued from previous page

- (b) State two other changes Sarah needed to make to the set-up in order to carry out a fair test. [1]

- (c) If rod A was translucent and rod B was opaque, describe the shadows formed by each rod on the screen. [2]

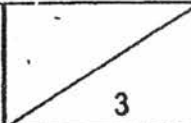
Score	
-------	---

2017 P6 Science Prelim

40. The diagram below shows identical lamps placed at the same distance from the three identical glass containers A, B and C.

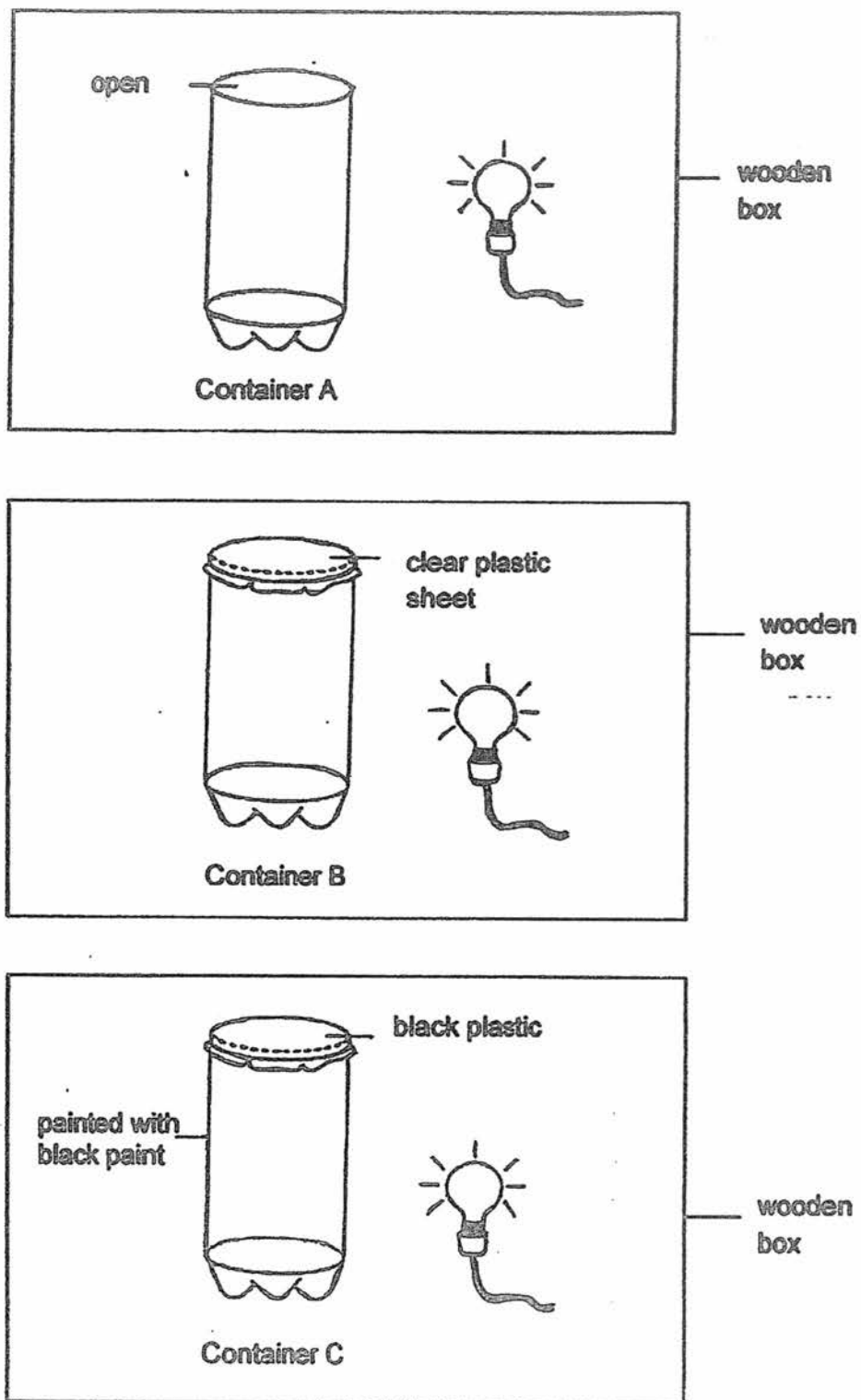

Continue on next page

Continued from previous page

The temperatures of the air in the three containers were measured after 20 minutes.

- (a) Arrange the containers A, B and C starting with the one which contained air of the lowest temperature. [1]

Lowest → highest

--	--	--

- (b) Explain how you arrive at the answer in (a). [2]

Container A : _____

Container C : _____

Score	3
-------	---

41. The diagram below shows how a train works with the help of steam.

Steam from the boiler is piped into the cylinder, causing the piston to move first one way then the other. As the piston pushes, the crank and connecting rod turn the locomotive's wheels and power the train along.

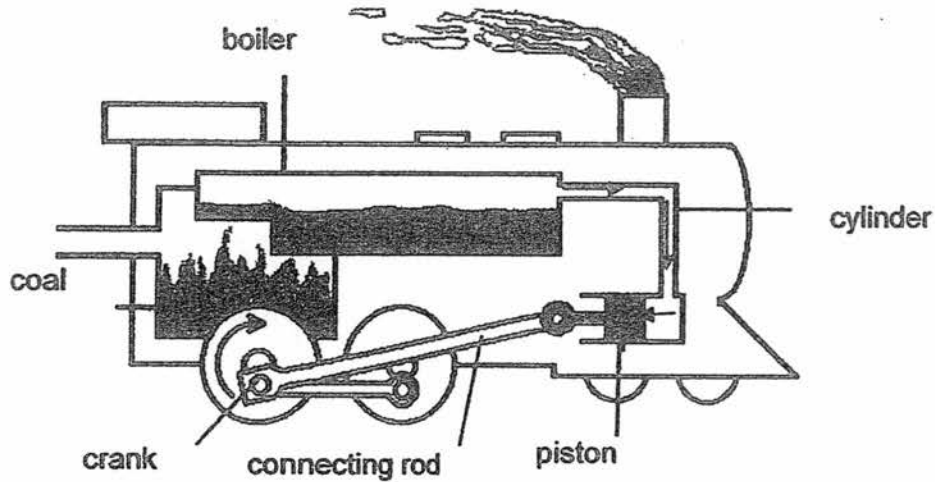

(a) What is the source of energy for the above train? [1]

(b) Complete the main energy conversion of the moving steam train. [1]

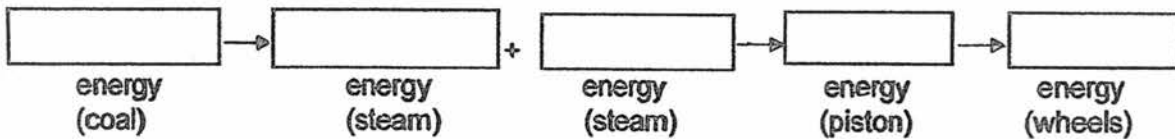

(c) Explain clearly how the burning of coal leads to global warming. [1]

- END OF PAPER -

Score	3
-------	---

YEAR : 2017
 LEVEL : PRIMARY 6
 SCHOOL : RAFFLES GIRLS' PRIMARY
 SUBJECT : SCIENCE
 TERM : PRELIMINARY EXAMINATION

Booklet A

Q1	Q2	Q3	Q4	Q5	Q6	Q7
3	1	2	4	1	4	2
Q8	Q9	Q10	Q11	Q12	Q13	Q14
3	4	3	1	2	3	2
Q15	Q16	Q17	Q18	Q19	Q20	Q21
2	3	1	2	4	1	2
Q22	Q23	Q24	Q25	Q26	Q27	Q28
1	1	4	3	3	4	3

Booklet B

Q29 (a) Does it live on land?

(b) Similarity : Both do not give birth to their young alive.
 Difference : Q has 2-legs while P does not.

Q30 (a) It is the anther, which produces pollen grains containing the male reproductive cell.

(b) (i) Flower A : By insects
 Reason : It's stigma and anther are smaller than the petals, thus when the insects lands on the flower to feed on nectar, the pollen grains will stick onto the insects legs and can then be brushed onto the stigma pollinating the flower.

(ii) Flower B : By wind
 Reason : The anther hangs out of the flower so that the pollen grains can be blown away at the slightest wind and can land on the stigma of another flower of the same type, which is large and feathery to easily catch the pollen grains.

- Q31 (a) The plant has the most amount of root that spread out the largest area and deepest so can hold the most soil together.
- (b) After a week, the swollen root would no longer be as swollen as before. The roots of the plant absorb mineral salts and nutrients which are needed for growth from fertile soil. However, in non-fertile soil, the mineral salts and nutrients are absent, so the plant has to obtain the mineral salts and nutrients from the stored food in the root. As more stored food is used up, the swollen root would be less swollen.
- Q32 (a) Food producer : W
 Predator : Z
- (b) If organisms W decreases, there will be less food for organisms X and organisms Y, resulting in the decrease of both organisms X and organisms Y.
- (c) Organisms Z would have the greatest amount of poison as it had two food sources contaminated with poison.
- Q33 (a) Animal X gets sufficient water from the low-growing plants and shrubs that it eats, and from the insects it eats to supplement its diet.
- (b) Animal X burrows at night to remain hidden from predators.
- (c) Bird Y and animal X have a mutualistic relationship. Bird Y gets food, needed for respiration and life processes from the tick while X can rid its body of ticks, so it will not have many diseases.
- Q34 (a) Heat gains. Metal expands when heated. The metal cover gains heat from the hot water and expanded, thus it would not be very tight and could be opened easily.
- (b) Heat loss. Metal contracts when cooled. Thus, the outer layer lost heat to the ice and contracted. When the boiling water was poured in, the inner layer gained heat from the water and expanded before the heat could be conducted to the outer layer. Hence, the jar started to crack.

Q35 (a) The moist air entering the underground pipes contains water vapour. When the warmer water vapour came into contact with the cooler underground pipe, it lost heat to the pipes and condensed to form water.

(b) Increase the surface area of solar panel and increase fan speed.

Q36 (a) The steel nail will be electromagnetised as steel is a magnetic material.

(b) When switch is closed, the steel rod will be electromagnetised and will attract the magnetic plate. Thus, the door will not open and will be locked.

Q37

S/N	Push	Pull
1	✓	✓
2	✓	✓
3	✓	✓
4	✓	

Q38 (a)

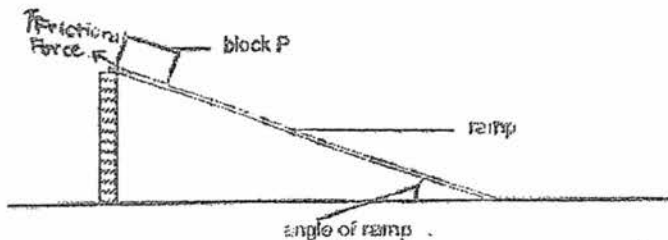

(b) Ramp X. The block could slide down when the angle of ramp X was the least, as the gravitational potential energy of the block could be converted to kinetic energy to overcome the friction between the block and ramp.

(c) No, it did not. As both blocks slide down when the angle of ramp is 40 they encountered same amount of friction, this shows that the area of contact does not affect the frictional force acting on the blocks.

- Q39 (a) Yes. It is to confirm that the results of the experiment are not affected by any external light source other than the light from the bulb.
- (b) She must use the same screen for both set-ups and the size of rods A and B must be the same.
- (c) The shadow formed by rod A would be lighter than the shadow formed by rod B.

Q40 (a) Lowest \longrightarrow highest

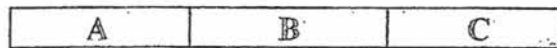

(b) Container A : Heat gained from the bulb by air in the container is lost to the surroundings most quickly.

Container C : Container C is covered with black plastic and is painted with black, which absorbs heat, so the heat is trapped in the container causing C's temperature to be heightened.

Q41 (a) The coal

(b)

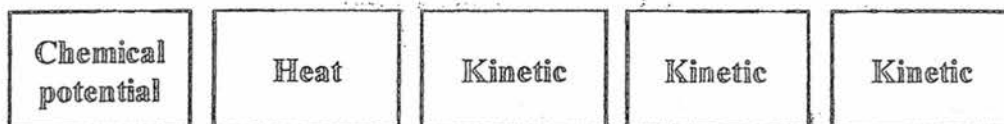

(c) Burning of fuels produces more carbon dioxide in the atmosphere that traps more heat from the sun and results in rise in Earth's average temperature.

End