



PEI HWA PRESBYTERIAN PRIMARY SCHOOL
PRELIMINARY EXAMINATION

PRIMARY 6
MATHEMATICS PAPER 1
(BOOKLET A)

18 August 2023

Name: _____

Form Class / Register No. : 6R _____ / _____

Total time for Booklets A and B: 1h

INSTRUCTIONS TO CANDIDATES

1. Write your Name, Class and Register No. in the spaces provided above.
2. DO NOT turn over this page until you are told to do so.
3. Follow all instructions carefully.
4. Answer all questions.
5. Shade your answers on the Optical Answer Sheet (OAS) provided.
6. The use of calculator is **NOT ALLOWED**.

This booklet consists of 6 printed pages, excluding the cover page.

Paper 1 (Booklet A)

Questions 1 to 10 carry 1 mark each. Questions 11 to 15 carry 2 marks each. For each question, four options are given. One of them is the correct answer. Make your choice (1, 2, 3 or 4). Shade the oval (1, 2, 3 or 4) on the Optical Answer Sheet. (20 marks)

1. Which of the following is a common multiple of 6 and 8?

(1) 12

(2) 16

(3) 18

(4) 24

2. What does the digit 3 in 6.375 stand for?

(1) 3 ones

(2) 3 tenths

(3) 3 hundredths

(4) 3 thousandths

3. Which of the following is equal to $4\frac{3}{5}$?

(1) $\frac{12}{5}$

(2) $\frac{17}{5}$

(3) $\frac{23}{5}$

(4) $\frac{43}{5}$

4. The diagram shows a home refrigerator. Which of the following could be the height of the refrigerator?

- (1) 1.8 cm
 (2) 18 cm
 (3) 1.8 m
 (4) 18 m

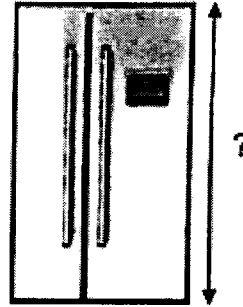

5. Sara had 6 pink, 9 purple and 5 brown ribbons. Find the ratio of the number of brown ribbons to the total number of ribbons she had.

- (1) 1 : 3
 (2) 1 : 4
 (3) 5 : 6
 (4) 5 : 9

6. What percentage of the stars are shaded?

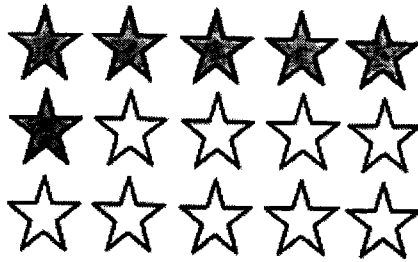

- (1) 6%
 (2) 9%
 (3) 40%
 (4) 60%

7. Arrange these masses from the heaviest to the lightest.

3.18 kg	3 kg 108 g	$3\frac{1}{8}$ kg
---------	------------	-------------------

Heaviest

Lightest

- (1) $3\frac{1}{8}$ kg , 3 kg 108 g , 3.18 kg
- (2) 3.18 kg , $3\frac{1}{8}$ kg , 3 kg 108 g
- (3) 3.18 kg , 3 kg 108 g , $3\frac{1}{8}$ kg
- (4) 3 kg 108 g , 3.18 kg , $3\frac{1}{8}$ kg

8. In the figure, how many of the six marked angles are greater than 90° ?

- (1) 5
- (2) 2
- (3) 3
- (4) 4

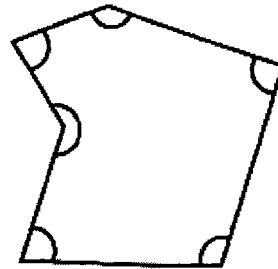

9. Which of the following is not a net of a solid?

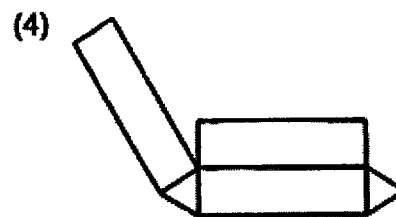
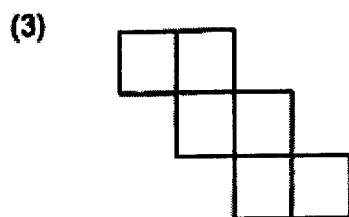
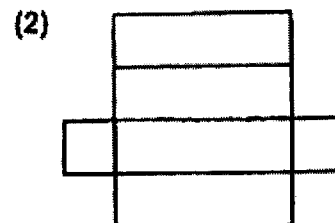
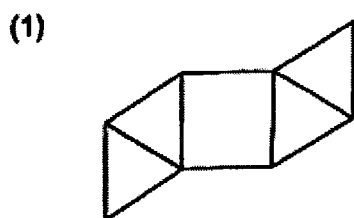

10. The table shows the mode of transport taken by a group of pupils to school. Which mode of transport is taken by the greatest number of pupils?

Mode of Transport	Number of Girls	Number of Boys
Car	35	35
Bus	34	39
Train	31	41
Cycling	19	25

- (1) Car
 (2) Bus
 (3) Train
 (4) Cycling
11. Kimi bought $\frac{3}{4}$ kg of flour. She used $\frac{1}{4}$ of it to bake a cake. She packed the remaining flour into 3 bags equally. How much flour did she have in each bag?

- (1) $\frac{1}{6}$ kg
 (2) $\frac{1}{16}$ kg
 (3) $\frac{3}{16}$ kg
 (4) $1\frac{1}{2}$ kg
12. A semicircle was cut from a rectangle as shown below. The perimeter of the rectangle before it was cut was 56 cm. What is the perimeter of the shaded figure? (Take $\pi = \frac{22}{7}$)

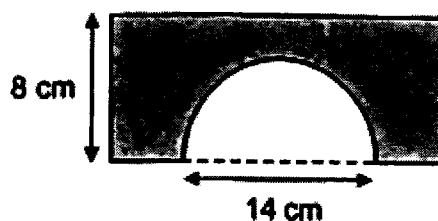

- (1) 58 cm
 (2) 64 cm
 (3) 80 cm
 (4) 86 cm

13. Danish reports to work at 09 30. The table shows the different travel options he can take to go to work.

	From	To	Mode	Duration
Option A	Home	Interchange	Walk	15 min
Option B	Home	Interchange	Bus	10 min
Option C	Interchange	Workplace	Bus	1 h 20 min
Option D	Interchange	Workplace	MRT	1 h 10 min

This morning, Danish left home at 07 55 and reached his workplace 10 minutes before his reporting time. Which travel options did he take?

- (1) A and C
 (2) A and D
 (3) B and C
 (4) B and D
14. In the figure, AOC and BOE are straight lines. $\angle AOB = 285^\circ$. Find $\angle EOD$.

- (1) 31°
 (2) 44°
 (3) 61°
 (4) 75°

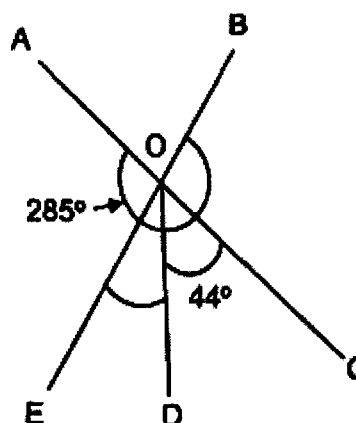

15. The bar graph shows the number of files sold from March to July.

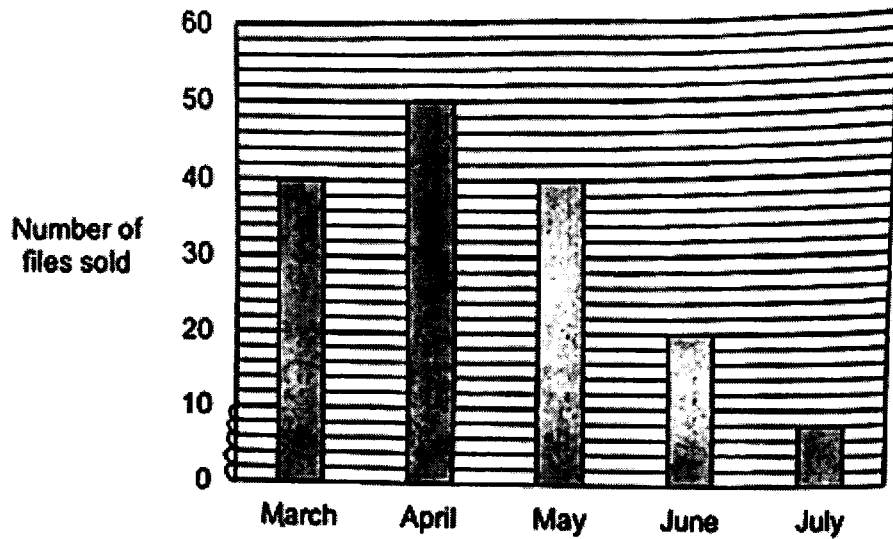

In which of the following months was the percentage change in the number of files sold the greatest?

- (1) March to April
- (2) April to May
- (3) May to June
- (4) June to July

- End of Booklet A -



PEI HWA PRESBYTERIAN PRIMARY SCHOOL
PRELIMINARY EXAMINATION

PRIMARY 6
MATHEMATICS PAPER 1
(BOOKLET B)

18 August 2023

Name: _____

Form Class / Register No. : 6R_____ / _____

Parent's Signature

Total time for Booklets A and B: 1h

INSTRUCTIONS TO CANDIDATES

1. Write your Name, Class and Register No. in the spaces provided above.
2. DO NOT turn over this page until you are told to do so.
3. Follow all instructions carefully.
4. Answer all questions.
5. Write all your answers in this booklet.
6. The use of calculator is **NOT ALLOWED**.

Marks (Booklet A) :	20
Marks (Booklet B) :	25
Total Marks (Booklets A and B) :	45

This booklet consists 8 printed pages, excluding the cover page.

Questions 16 to 20 carry 1 mark each. Write your answers in the spaces provided. For questions which require units, give your answers in the units stated. (5 marks)

Do not write
in this space

16. Find the value of $\frac{3}{8} \times \frac{4}{9}$

Ans: _____

17. Express 2.9% as a decimal.

Ans: _____

18. How much water is in the container?

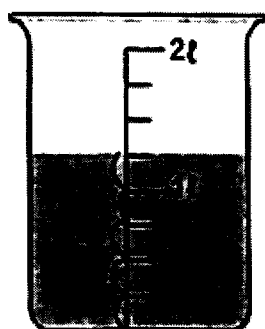

Ans: _____ ml

19. In the figure, ABCD is a trapezium and BCEF is a square. $\angle DCE = 203^\circ$. Find $\angle ABC$.

Do not write in this space

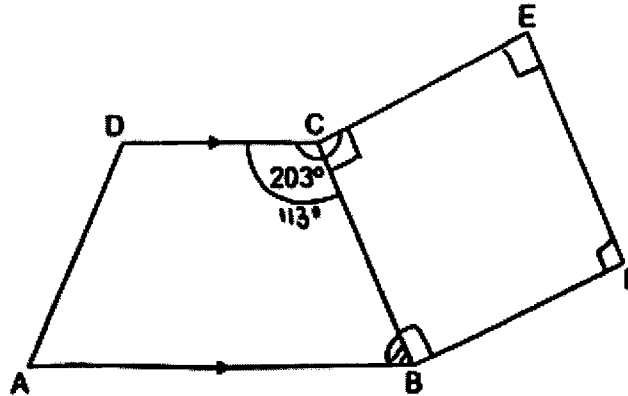

Ans: _____°

20. The picture graph shows the number of bags that were sold by a shop from Monday to Thursday.

Monday	☆☆☆☆
Tuesday	☆☆☆
Wednesday	☆☆☆☆☆☆
Thursday	☆☆☆☆
Each ☆ represents 2 bags.	

What was the average number of bags sold over the 4 days?

Ans: _____

Questions 21 to 30 carry 2 marks each. Show your working clearly and write your answers in the spaces provided. For questions which require units, give your answers in the units stated. (20 marks)

Do not write
in this space

21. (a) Simplify $12e + 10 - 4e - 7 + 3e$

Ans: (a) _____

(b) Find the value of $4n + \frac{3n-7}{2}$ when n is 5.

Ans: (b) _____

22. (a) Find the value of $8.92 - 3.50$

Ans: (a) _____

(b) Find the value of $7.21 + 70$

Ans: (b) _____

Do not write
in this space

23. A car travels 270 km on 30 l of petrol.

(a) How many kilometres can the car travel on 1 l of petrol?

Ans: (a) _____ km

(b) How much petrol is needed for the car to travel 180 km?

Ans: (b) _____ l

24. Ben had some marbles. The number of blue marbles was $\frac{1}{2}$ the number of red marbles. The number of red marbles was $\frac{4}{5}$ the number of green marbles.

(a) Find the ratio of the number of blue marbles to the number of red marbles to the number of green marbles.

Ans: (a) _____

(b) There were 42 blue and green marbles altogether. How many red marbles were there?

Ans: (b) _____

25. The figure ABCD shows two right-angled triangles ABC and ACD joined together at line AC. Find the shaded area AECF.

Do not write
in this space

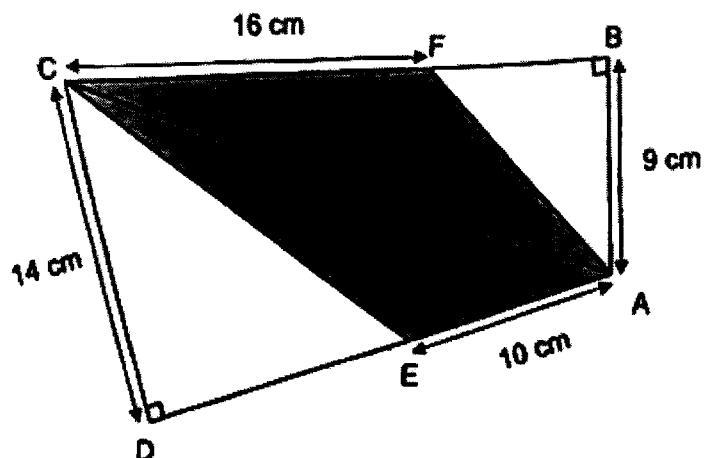

Ans: _____ cm²

26. The figure is made up of 3 identical rectangles. The perimeter of the figure is 60 cm. What is the area of 1 rectangle?

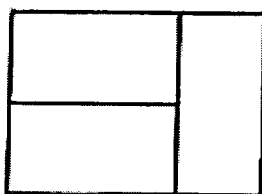

Ans: _____ cm²

27. The square grid shows the positions of A, B, C, D, E, F, G and H.

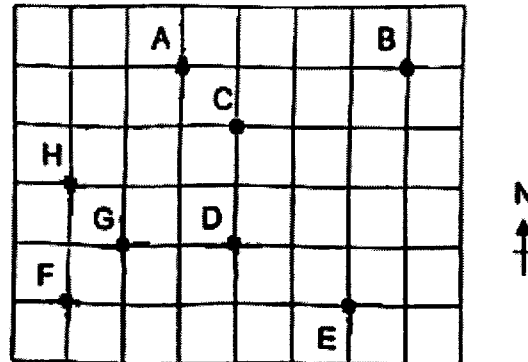

Do not write
in this space

- (a) In the square grid, point _____ is north-west of point G.

Ans: (a) _____

- (b) John is standing at one of the points in the square grid. He is facing point C. When he makes a $\frac{3}{4}$ - turn clockwise, he faces point G. Which point is he standing at?

Ans: (b) _____

28. A container of juice can fill either 35 bottles or 55 cups exactly. The capacity of each bottle is 60 ml more than each cup. What is the capacity of a cup?

Ans: _____ ml

29. Lina had \$800 in her wallet. She spent some money from January to May. The line graph shows the amount of money in her wallet at the start of each month.

Do not write in this space

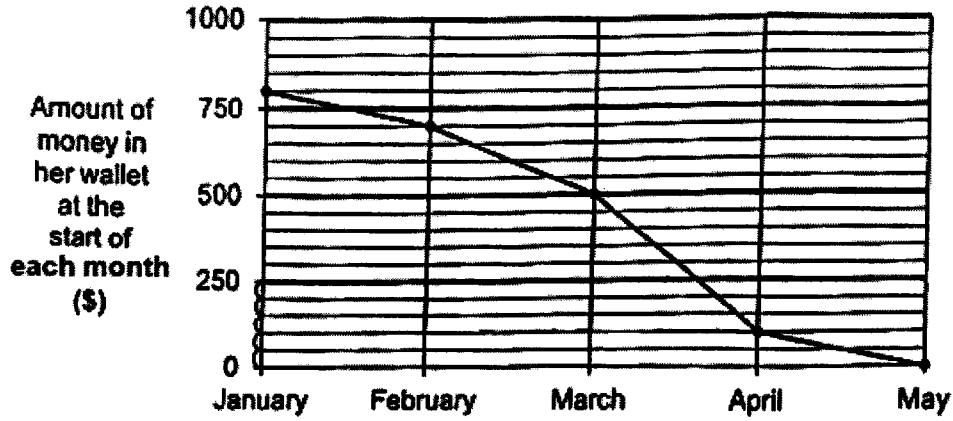

- (a) In which month did Lina spend half of the money she had at first?

Ans: (a) _____

- (b) The amount of money Lina spent in each month can be represented in the pie chart.

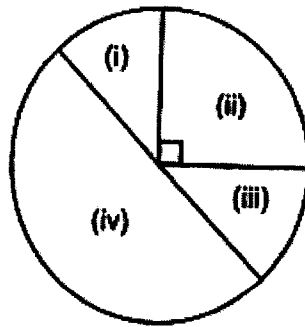

Complete the pie chart with the month that represents the amount of money Lina spent. Write J for January, F for February, M for March and A for April in the blanks below.

Ans: (b) (i) _____, (ii) _____, (iii) _____, (iv) _____



30. A triangle ABC is drawn on a square grid.

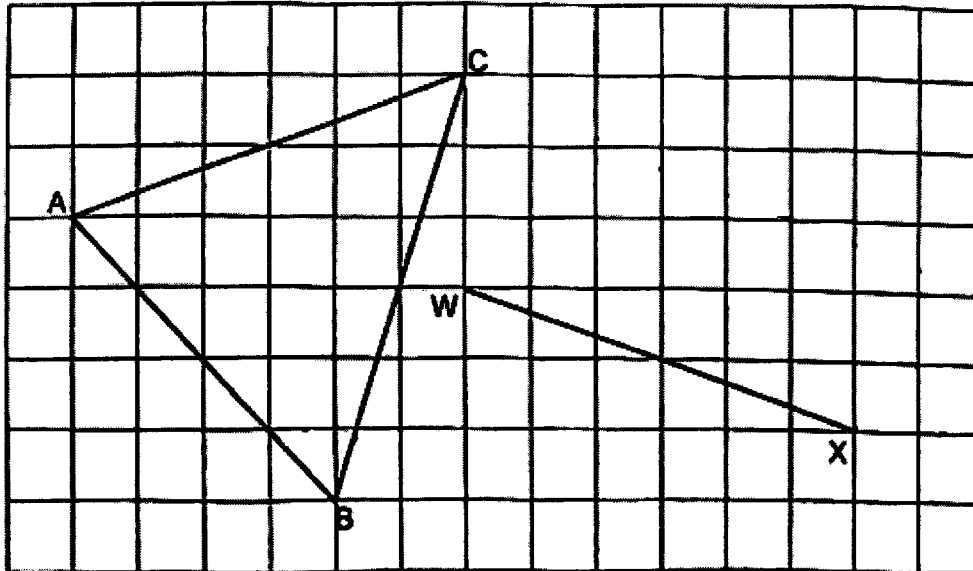

- (a) Measure and write down the size of $\angle ABC$.

Ans: (a) _____

- (b) Using the line WX, draw a parallelogram WXYZ such that it has the same perimeter as triangle ABC. Use a pencil to draw your diagram and label it clearly.

End of paper



PEI HWA PRESBYTERIAN PRIMARY SCHOOL
PRELIMINARY EXAMINATION

PRIMARY 6
MATHEMATICS
PAPER 2

18 August 2023

Name: _____

Parent's signature

Form Class / Register No. : 6R _____ / _____

Total time: 1h 30min

INSTRUCTIONS TO CANDIDATES

1. Write your Name, Class and Register No. in the spaces provided above.
2. DO NOT turn over this page until you are told to do so.
3. Follow all instructions carefully.
4. Answer all questions.
5. Write all your answers in this booklet.
6. The use of an approved calculator is expected, where appropriate.

Booklet A :		Booklet B :		Total:	45
				Paper 2 :	55
				Total Marks :	100

This booklet consists of 17 printed pages, excluding the cover page.

Questions 1 to 5 carry 2 marks each. Show your working clearly and write your answers in the spaces provided. For questions which require units, give your answers in the units stated. (10 marks)

1. Use all the digits 0, 4, 5, 9 to form
- (a) the largest number that is a multiple of 5.

Ans: (a) _____

- (b) the number that is closest to 5000.

Ans: (b) _____

2. Cubes A, B, C, D, E and F are used to build a solid.

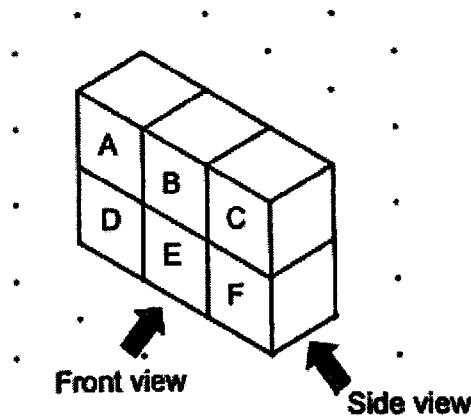

Name the cubes to be removed to have the same top, front and side views as shown below.



Top View

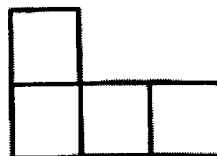

Front View



Side View

Ans: _____

Please do not write beyond this margin

Please do not write beyond this margin

Please do not write in the margin



3. The pie chart represents the sports played by some Primary 6 pupils. The number of pupils who played each sport is shown in the table.

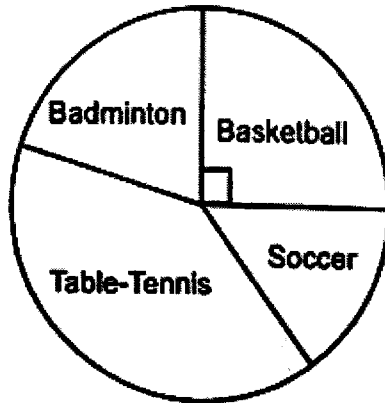

Sport	Number of Pupils
Soccer	?
Basketball	47
Badminton	38
Table-Tennis	75

How many pupils played soccer?

Ans: _____

4. At a fruit shop, $\frac{5}{8}$ of the fruits were apples and the rest were oranges. $\frac{2}{5}$ of the apples and 104 oranges were sold. Half of the total fruits at first were left. How many fruits were there at first?

Ans: _____

Please do not write in the margin

5. The figure shows part of a trapezium. The dotted line is the line of symmetry.

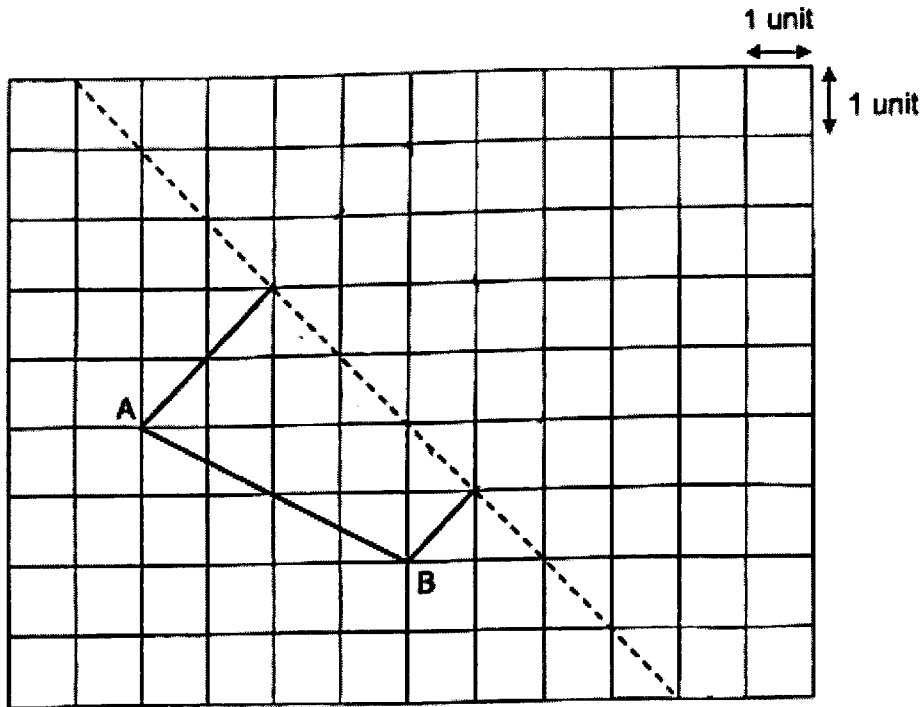

- (a) Draw on the square grid to complete trapezium ABCD. Use a pencil to draw your diagram and label it clearly.
- (b) What is the area of the trapezium?

Ans: (b) _____ square units

Please do not write beyond this margin

Please do not write beyond this margin

Please do not write in the margin



For questions 6 to 17, show your working clearly and write your answers in the spaces provided. The number of marks available is shown in brackets [] at the end of each question or part-question. (45 marks)

6. A car and a van were 532 km apart. At 10.40 a.m., the car and the van started to travel towards each other. The car travelled at 87 km/h while the van travelled at 65 km/h. Both vehicles did not change their speeds throughout.

- (a) What was the total distance travelled by both vehicles in an hour?

Ans: (a) _____ [1]

- (b) At what time would the two vehicles meet?
Leave your answer in 24-hour clock.

Ans: (b) _____ [2]

Please do not write beyond this margin

Please do not write beyond this margin

Please do not write in the margin



7. A shop was having a sale.

Sale		
$\$3y$  Dress	$\$y$  Shirt	$\$(y + 20)$  Shorts
Buy any 2 and get \$5 off. Buy any 3 and get \$10 off.		

- (a) Beth bought a dress and a shirt. How much did she pay altogether? Give your answer in terms of y in its simplest form.

Ans: (a) _____ [1]

- (b) Ann bought one of each item. She paid a total of \$140. Find the value of y .

Ans: (b) _____ [2]

Please do not write in the margin



Please do not write beyond this margin

Please do not write beyond this margin

8. There were 80 more boys than girls in a club. 10% of the boys went for a camp and the remaining number of pupils in the club became 1402 pupils. How many girls were there in the club?

Ans: _____ [3]

9. The figure shows a quarter circle ABC and a rectangle CDEF. The length of AC is 10 cm. The sum of the lengths of EF and ED is 14 cm.

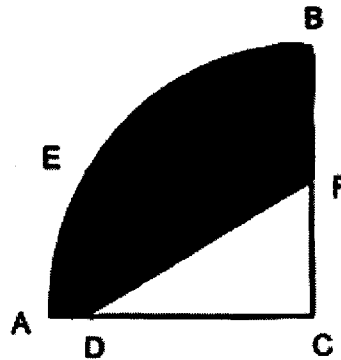

(Take $\pi = 3.14$)

- (a) Find the area of the quarter circle ABC.

Ans: (a) _____ [1]

- (b) Find the perimeter of the shaded part DABF.

Ans: (b) _____ [2]

Please do not write in the margin

Please do not write beyond this margin

Please do not write beyond this margin

10. The bar graphs show the number of books sold by shops A, B and C in 2020 and 2021. Shop A sold the same number of books in 2020 and 2021. The number of books sold is not shown on both scales.

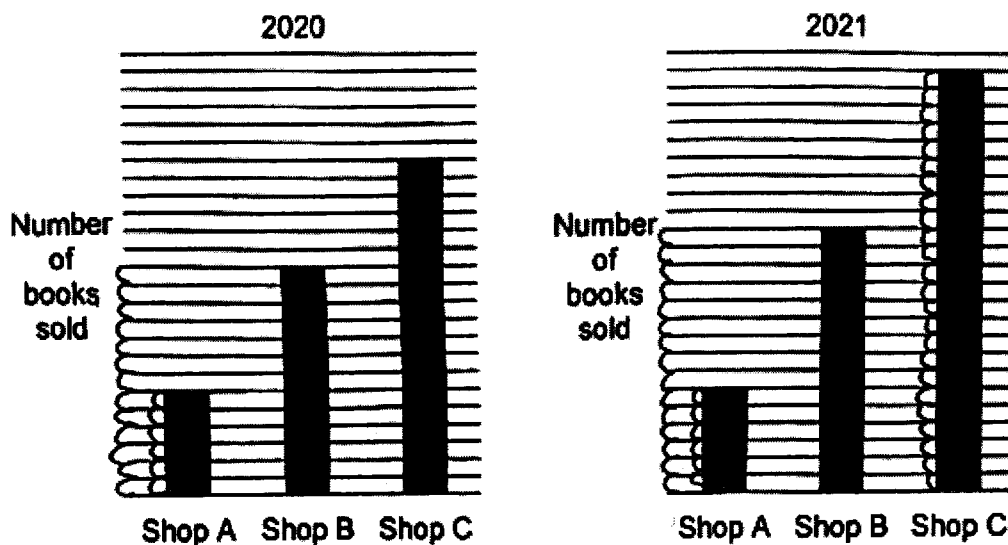

- (a) The total number of books sold by shop B in 2020 and 2021 was 420. How many books did shop A sell in the two years?

Ans: (a) _____ [1]

- (b) Shops B and C sold the same number of books in 2022. Shop C had a 25% decrease in the number of books sold from 2021 to 2022. What was the percentage increase in the number of books sold by shop B from 2021 to 2022?

Ans: (b) _____ [2]

Please do not write beyond this margin

Please do not write beyond this margin

Please do not write in the margin



11. Gopal uses cubes to form solids that follow a pattern. The first four solids are shown below.

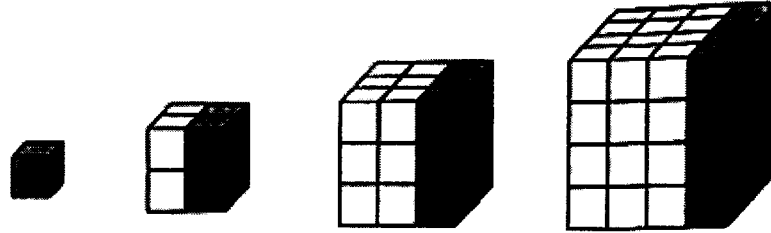

Solid 1 Solid 2 Solid 3 Solid 4

(a) Study the pattern and complete the table for solid 5.

Solid	Number of painted cubes	Number of unpainted cubes	Total number of cubes
1	1	0	1
2	4	4	8
3	9	18	27
4	16	48	64
5			125

[1]

(b) Which solid has 196 painted cubes?

Ans: (b) _____ [1]

(c) A total of 5832 cubes are used to build a solid.
How many unpainted cubes are used in the solid?

Ans: (c) _____ [2]

Please do not write beyond this margin

Please do not write beyond this margin

Please do not write in the margin



12. A shop sells big boxes and small boxes as shown.

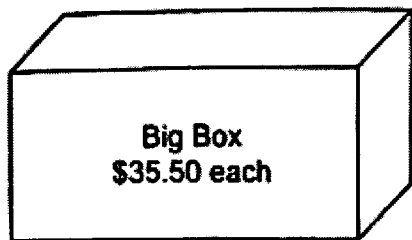

Raja and Hannah bought the same total number of boxes. Both of them bought some big boxes. Raja bought 37 small boxes while Hannah bought 9 small boxes.

- (a) Who paid more for the boxes?
Find the difference in the amount paid by Raja and Hannah.

Ans: (a) Name: _____

Amount: _____ [2]

- (b) Raja and Hannah spent less than \$3000 on the boxes altogether. What was the greatest possible number of big boxes Raja bought?

Ans: (b) _____ [2]

Please do not write in the margin

Please do not write beyond this margin

Please do not write beyond this margin

13. Mrs Fu spent $\frac{3}{7}$ of her money on 30 mangoes and some apples. The ratio of the cost of each mango to the cost of each apple was 5 : 3. She bought some more mangoes with $\frac{5}{8}$ of the remaining money and saved the rest of her money. She bought a total of 205 mangoes.

(a) How many apples did Mrs Fu buy?

Ans: (a) _____ [3]

(b) Mrs Fu used the same number of mangoes and apples she had to bake fruit tarts. In the end, the ratio of the number of mangoes left to the number of apples left was 1 : 6. How many apples did she use to bake the fruit tarts?

Ans: (b) _____ [2]

Please do not write in the margin



Please do not write beyond this margin

Please do not write beyond this margin

14. ABCD is a square and CDEF is a rhombus. EFG is a triangle. ECG is a straight line. $\angle EFG = 88^\circ$.

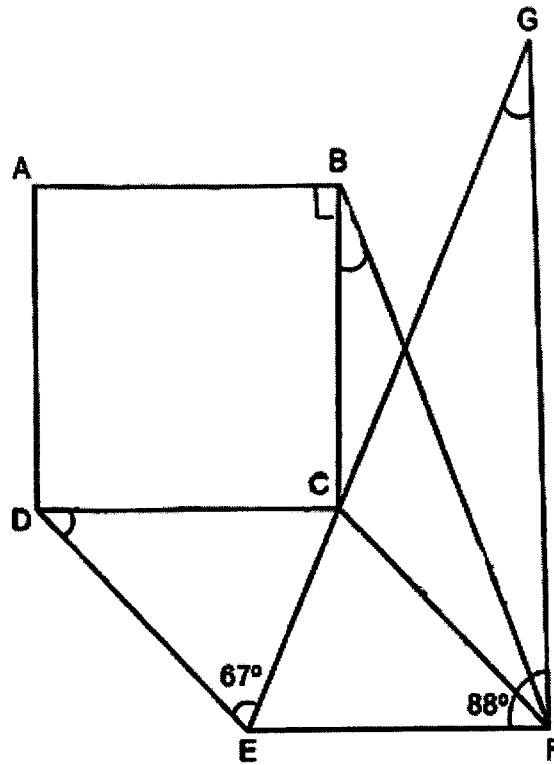

- (a) Find $\angle EDC$.

Ans: (a) _____ [1]

- (b) Find $\angle EGF$.

Ans: (b) _____ [1]

- (c) Find $\angle CBF$.

Ans: (c) _____ [2]

Please do not write in the margin

Please do not write beyond this margin

Please do not write beyond this margin

15. The diagram shows 2 tanks, X and Y, of different dimensions. X was empty while Y was filled with 25.2 l of water.

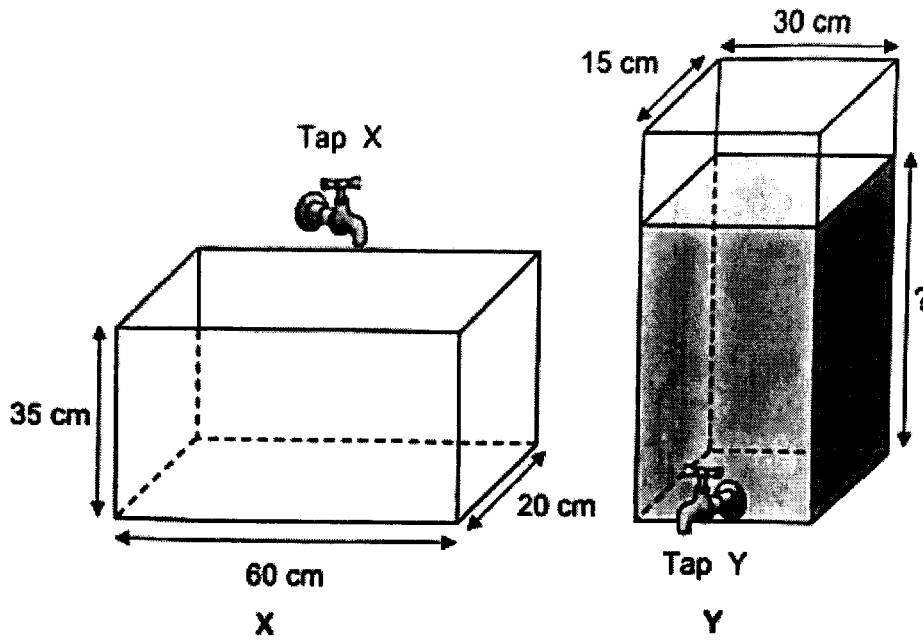

- (a) What was the height of the water level in Y?

Ans: (a) _____ [1]

- (b) At 9 a.m., water from Tap X flowed in at a rate of 7.2 l/min while water flowed out from Tap Y at a rate of 3.6 l/min. Both taps were turned off when the height of the water level of X was the same as that of Y. At what time were the taps turned off?

Ans: (b) _____ [3]

Please do not write beyond this margin

Please do not write beyond this margin

Please do not write in the margin



**BLANK
PAGE**

16. Sam had a trapezium ABCD and an equilateral triangle EFG. He folded the trapezium along the line DH to form a parallelogram HBCD. He then pasted the triangle over the parallelogram as shown.

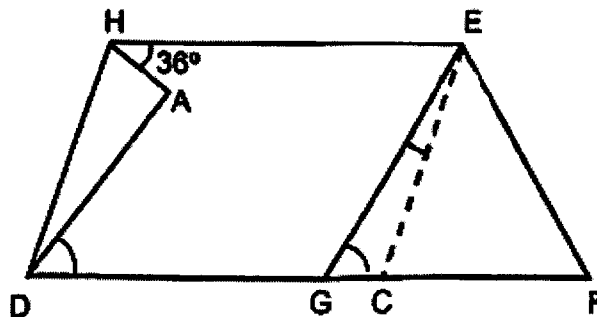
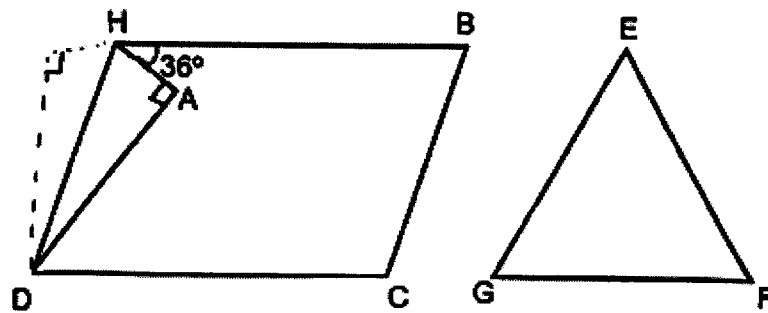
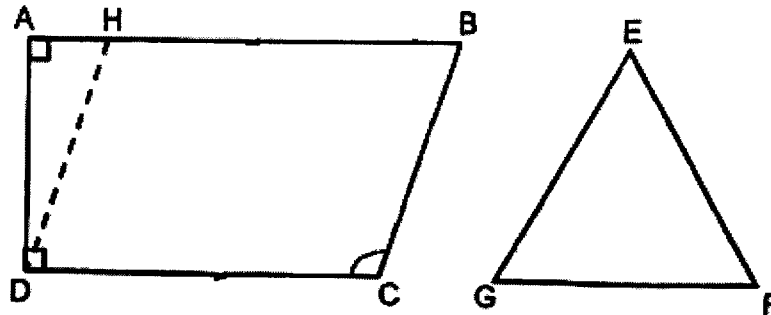

Please do not write beyond this margin

Please do not write beyond this margin

Please do not write in the margin

(a) Find $\angle ADG$.

Ans: (a) _____ [3]

(b) Find $\angle CEG$.

Ans: (b) _____ [2]

Please do not write beyond this margin

Please do not write beyond this margin

Please do not write in the margin



17. A company used two machines A and B with different printing rates to print stickers. The graphs below show the total number of stickers printed by each machine from 1 p.m.

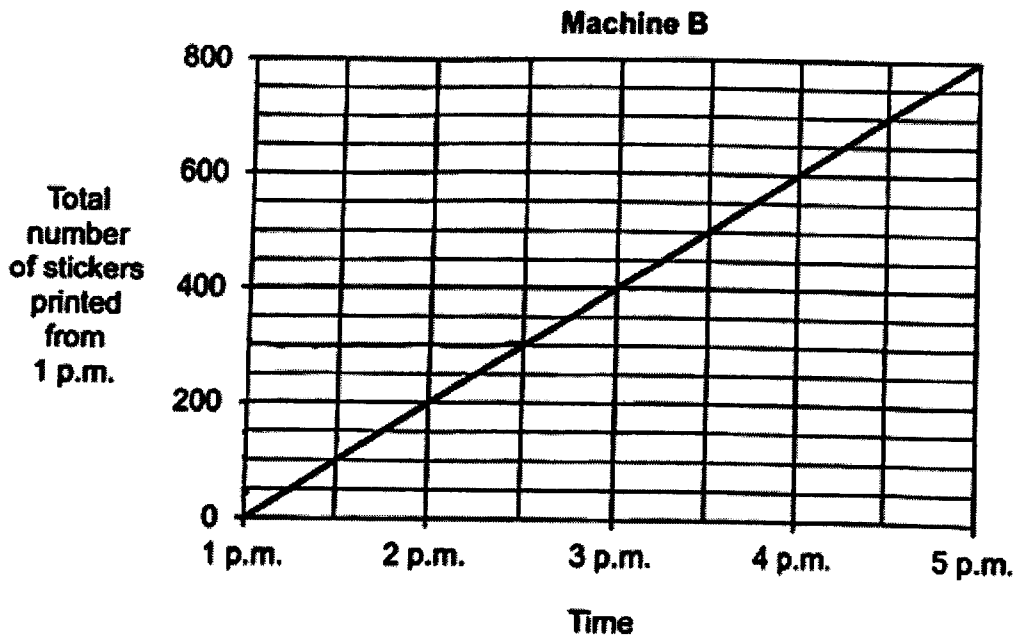
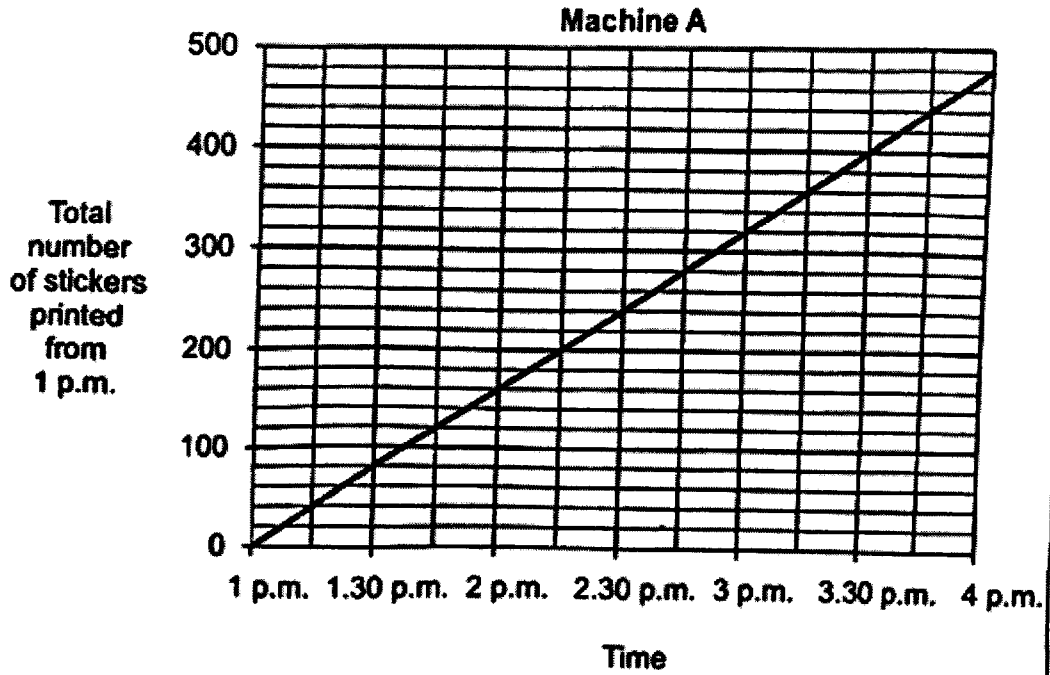

Please do not write beyond this margin

Please do not write beyond this margin

Please do not write in the margin

(a)

Statement	True	False	Not Possible to Tell
Machine B printed 40 more stickers than machine A in the first hour.			
Machine A took 30 minutes less than machine B to print 400 stickers.			
Machines A and B printed a total of 640 stickers in $1\frac{1}{2}$ hours.			

[2]

- (b) Both machines did not change their rates of printing throughout. When machine B had printed 800 stickers, how many stickers had machine A printed?

Ans: _____ [2]

Please do not write in the margin
End of paper



Please do not write beyond this margin

Please do not write beyond this margin

SCHOOL : PEI HWA SCHOOL
 LEVEL : PRIMARY 6
 SUBJECT : MATH
 TERM : 2023 PRELIM

PAPER 1 BOOKLET A

Q1	Q2	Q3	Q4	Q5	Q6	Q7	Q8	Q9	Q10
4	2	3	3	2	3	2	3	4	2

Q11	Q12	Q13	Q14	Q15
3	2	2	1	4

PAPER 1 BOOKLET B

Q16)	$\frac{3}{18}$
Q17)	0.029
Q18)	1250ml
Q19)	67°
Q20)	10
Q21)	a) $11e+3$ b) 24
Q22)	a) 5.42 b) 0.103
Q23)	a) 9km b) 20L
Q24)	a) 2:4:5 b) 24
Q25)	142cm ²
Q26)	72cm ²
Q27)	a) H b) D
Q28)	105ml

- Q29) a) March
 b) i)J ii)F, iii)A, iv)M

Q30)
 a)62
 °

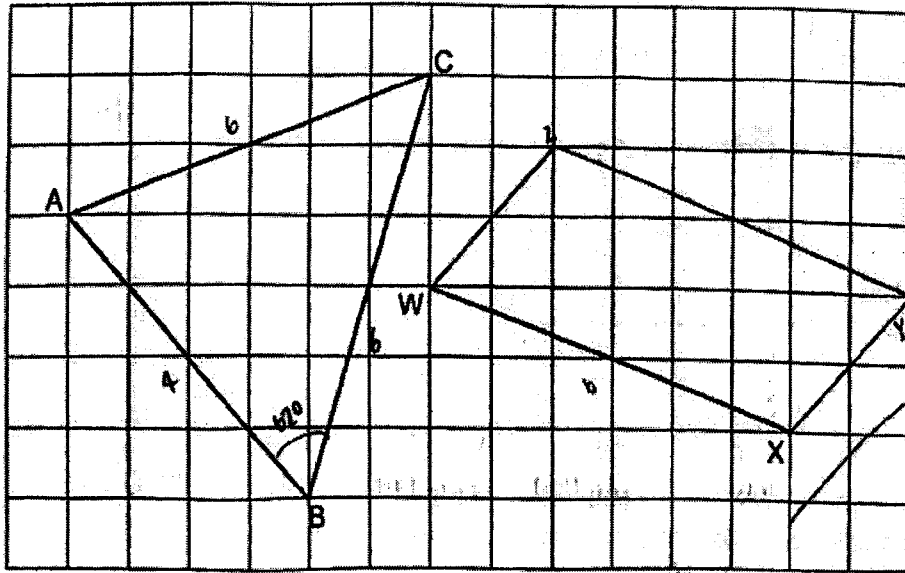

b)2

PAPER 2

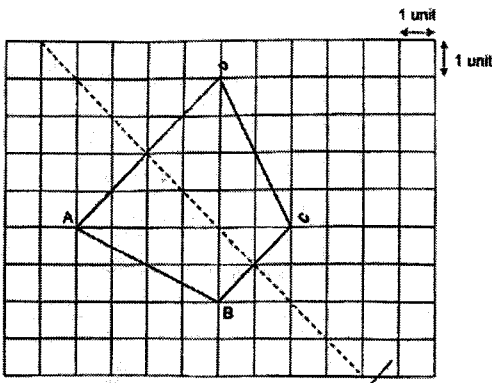
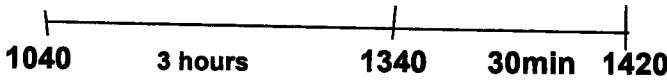
Q1)	<p>a)9540 b)5094</p>
Q2)	B+C
Q3)	28
Q4)	<p>$8 \div 2 = 4$ $4 - 3 = 1$ $1u = \text{left } (0)$ $104 \div 2 = 52$ $52 \times 8 = 416$</p>
Q5)	<p>a)</p>  <p>b) $9 \times 2 = 18$ square units</p>
Q6)	<p>a) $87 + 65 = 152\text{km}$</p> <p>b) $532 \div 152 = 3\frac{1}{2} = 3 \text{ hours } 30 \text{ min}$</p>  <p>Ans : 1420</p>

Q7)	<p>a) $\\$(4y-5)$ b) $140 + 10 = 150$ $150 - 20 = 130$ $130 \div 5 = 26$</p>
Q8)	<p>190% $\rightarrow 1402 + 80 = 1482$ 10% $\rightarrow 78$ 100% $\rightarrow 780$ $780 - 80 = 700$</p>
Q9)	<p>a) $\frac{1}{4} \times 3.14 \times 10 \times 10 = 78.5\text{cm}^2$ b) $\frac{1}{4} \times 3.14 \times 20 = 15.7$ $15.7 + 6 + 10 = 31.7\text{cm}$</p>
Q10)	<p>a) $13 = 15 = 28$ $420 \div 28 = 15$ $15 \times 12 = 180$</p> <p>b) $100 - 25 = 15$ $15 \times 24 = 360$ $360 \div 100 = 3.6$ $3.6 \times 75 = 270$ $15 \times 15 = 225$ $270 - 225 = 45$ $45/225 \times 100 = 20\%$</p>
Q11)	<p>a) 25 , 100, 125 b) 14 c) 5508</p>
Q12)	<p>a) Hannah b) $35.50 - 9.80 = 25.70$ $28 \times 25.70 = \\$719.69$ c) 21</p>
Q13)	<p>a) 300 b) 186</p>
Q14)	<p>a) $180^\circ - 67^\circ - 67^\circ = 46^\circ$ b) $180^\circ - 88^\circ - 67^\circ = 25^\circ$ c) $360^\circ - 90^\circ - 67^\circ - 67^\circ = 136^\circ$ $(180^\circ - 136^\circ) \div 2 = 22^\circ$</p>

Q15)	a) $25.2\text{L} = 25200\text{ml}$ $25200 \div 15 \div 30 = 56\text{cm}$ b) 9.04 a.m.
Q16)	a) 54° b) 12°
Q17)	a) True False False b) $480 - 160 = 320$

