

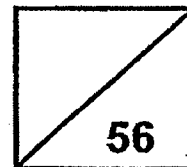

**Rosyth School
Preliminary Examination 2018
SCIENCE
Primary 6**

**Total
Marks:**



Name: _____

Class: Pr 6. _____ **Register No.** _____ **Duration:** 1 h 45 min

Date: 24 Aug 2018 **Parent's Signature:** _____

Booklet A

Instructions to Pupils:

- 1. Do not open the booklets until you are told to do so.**
- 2. Follow all instructions carefully.**
- 3. This paper consists of 2 booklets - Booklet A and Booklet B**
- 4. For questions 1 to 28 in Booklet A, shade the correct ovals on the Optical Answer Sheet (OAS) provided using a 2B pencil.**
- 5. For questions 29 to 40, give your answers in the spaces given in Booklet B.**

*** This booklet consists of 20 printed pages (including cover page).**

This paper is not to be reproduced in part or whole without the permission of the Principal.

Part I

For each question from 1 to 28, four options are given. One of them is the correct answer. Make your choice (1, 2, 3 or 4). Shade the correct oval (1, 2, 3 or 4) on the Optical Answer Sheet. (56 Marks)

1 Which of the following characteristic is found in insects, but not in other animals?

- (1) They lay eggs.
- (2) They have wings.
- (3) They have feelers.
- (4) They have three body parts.

2 The graph below shows the change in the population of zebras in a grassland habitat over a period of time. Zebras feed on grass only.

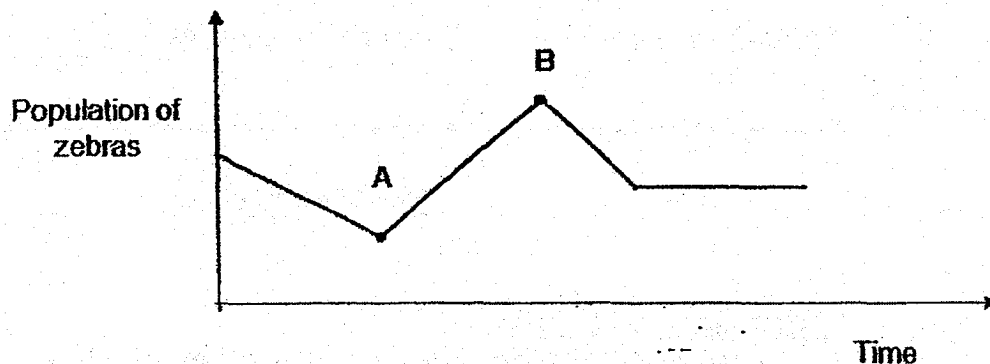

Which of the following events most likely could have led to the change in the zebra population from Point A to Point B?

- (1) There was a drought in the grassland.
- (2) There was an introduction of a new disease.
- (3) There was overeating of grass by animals in the grassland.
- (4) There was a decrease in the population of the zebra's predators.

3 Which of the following shows how the carbon dioxide is removed from a human body?

- (1) bloodstream → windpipe → lungs → nose
- (2) bloodstream → lungs → windpipe → nose
- (3) windpipe → lungs → bloodstream → nose
- (4) nose → windpipe → lungs → bloodstream

- 4 The following relationships were observed among five organisms, A, B, C, D and E living in a habitat.

C feeds on A, B and D.
 B feeds on A.
 E feeds on C.

Which one of the following is correct?

	Producer	Prey	Prey and predator	Predator
(1)	A,D	B	C	E
(2)	A	B,D	C	E
(3)	A,D	C	B	E
(4)	D	A,C	E	B

- 5 The diagram below shows a rotting log.

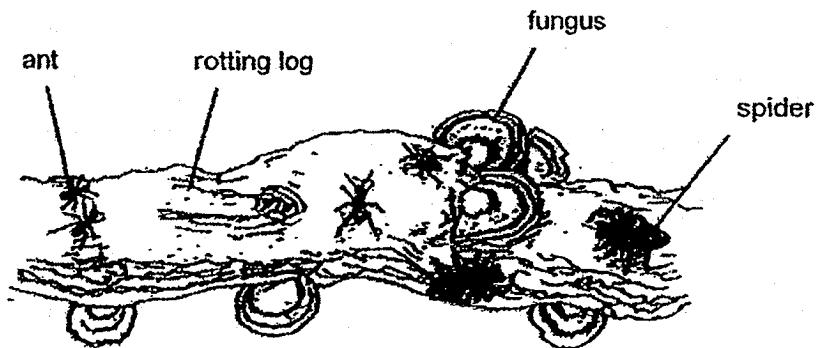

Based only on the diagram, which one of the statements is correct?

- (1) The population size of the fungus is two.
 (2) The rotting log is an example of a single plant population.
 (3) There is only one population of insect living on the rotting log.
 (4) There are two populations of organisms living on the rotting log.

- 6 A farmer has two different types of soil, G and H. Each soil was taken from two different layers, top or bottom soil.

He predicted that plants will grow more healthily in soil G while his friend predicted that plants will grow more healthily in the top soil of soil H.

Which of the following set-ups should the farmer use to provide a correct test for both their predictions?



(1)

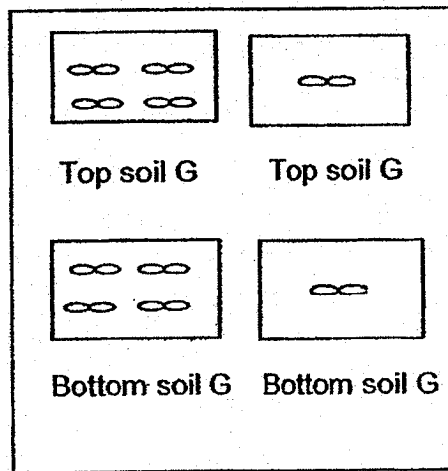

(2)

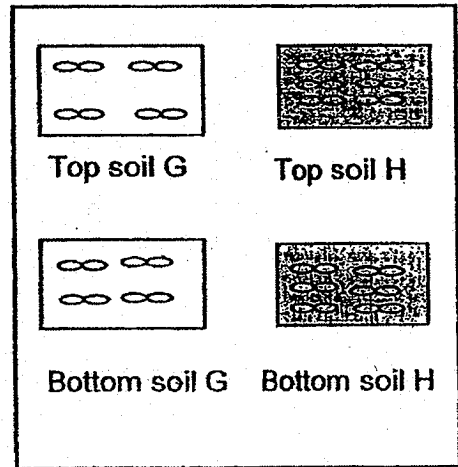

(3)

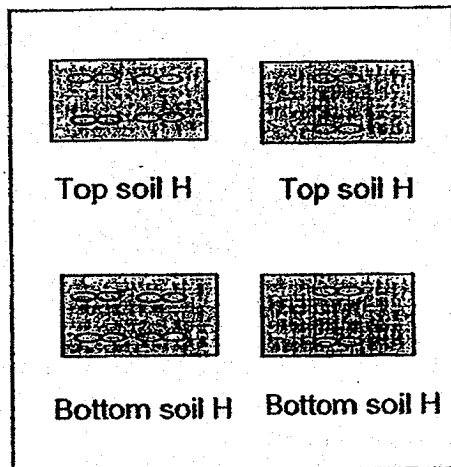

(4)

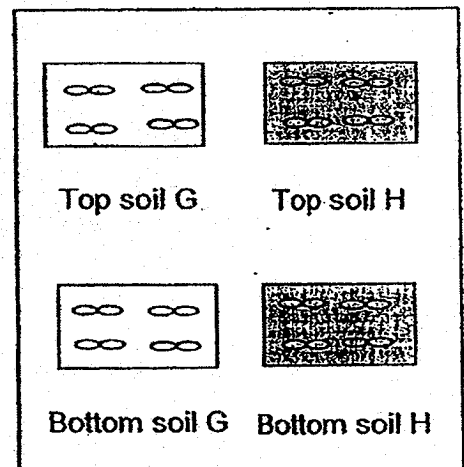

7 Which one of the following causes increased greenhouse effect?

- (1) Oil spill
- (2) Soil erosion
- (3) Deforestation
- (4) Global warming

8 Dennis wanted to find out if plant takes in water through its roots. Which one of the following should Dennis use as an experimental set-up?

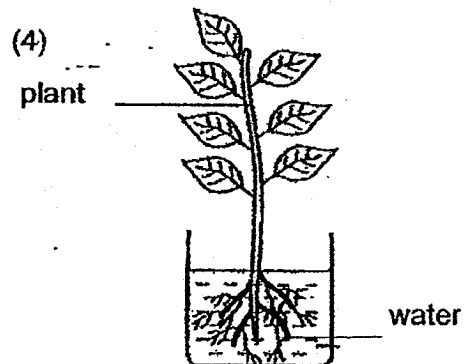
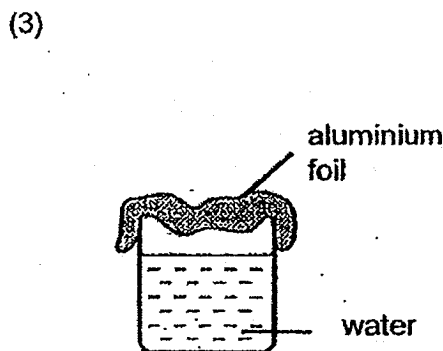
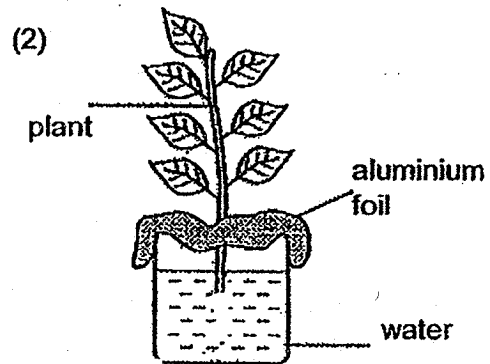
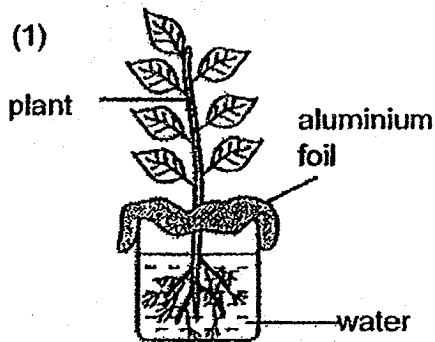

9 What is the function of cytoplasm in animal cell?

- (1) Controls cell activities
- (2) Controls inheritance from one generation to another
- (3) Controls the movement of substances within the cell
- (4) Controls the movement of substances in and out of the cell

- 10 Wei Liang prepared two set-ups, X and Y for an experiment. In Set-up X, he put a plant into a container of red coloured water and covered the plant with a plastic bag. In Set-up Y, he replaced the plant with a stick instead and covered it with a plastic bag. The two set-ups were placed in the same location.

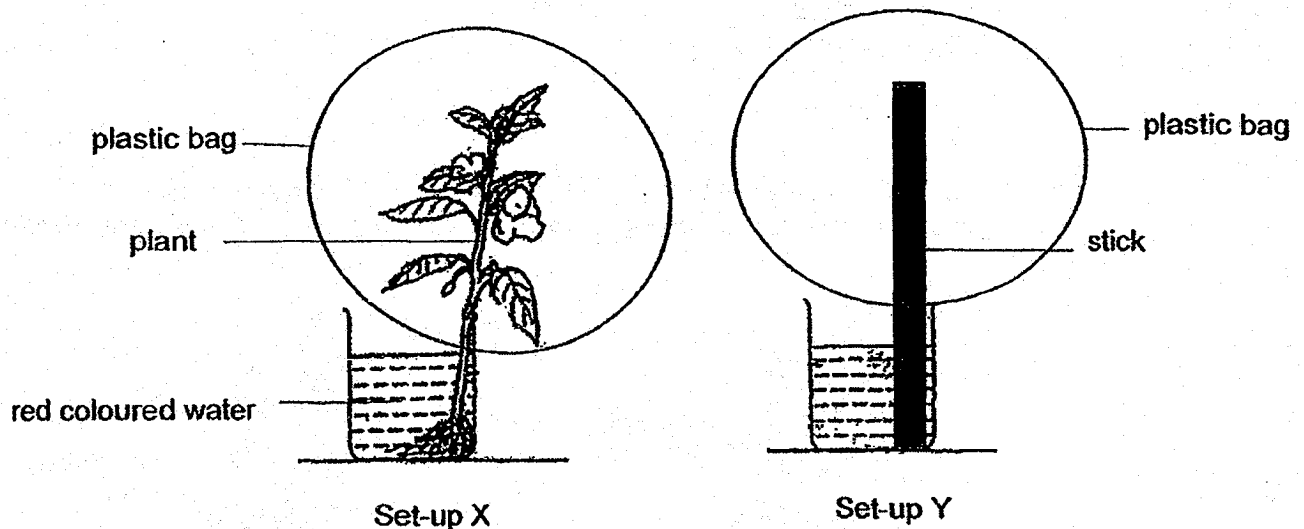

An hour later, the water level in Set-up X was less than before. Wei Liang also found tiny water droplets on the inner surface of the plastic bag in Set-up X but not in Set-up Y.

Based on Wei Liang's observation, what conclusion could he make from his experiment?

- (1) Water is absorbed through its roots.
- (2) Water in both containers is lost through evaporation.
- (3) Water droplets formed is due to the presence of the plant.
- (4) Water droplets formed is due to the presence of air in the plastic bag.

- 11 Study the diagram below which shows the movement of substances in the plant.

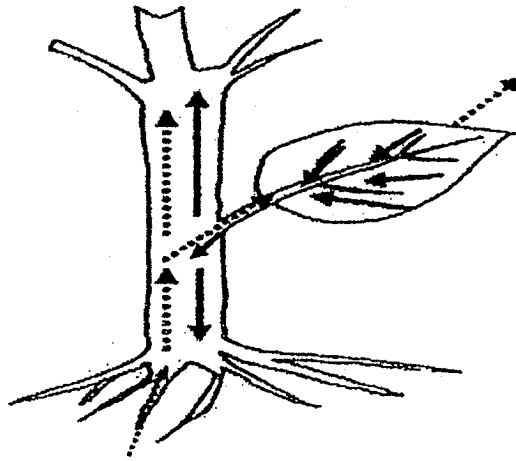

Which one of the following shows the correct movement of substances in the plant?

	—————→→
(1)	starch	water
(2)	sugar	water
(3)	food	oxygen
(4)	oxygen	carbon dioxide

12 The chart below shows the characteristics of different organisms J, K and L.

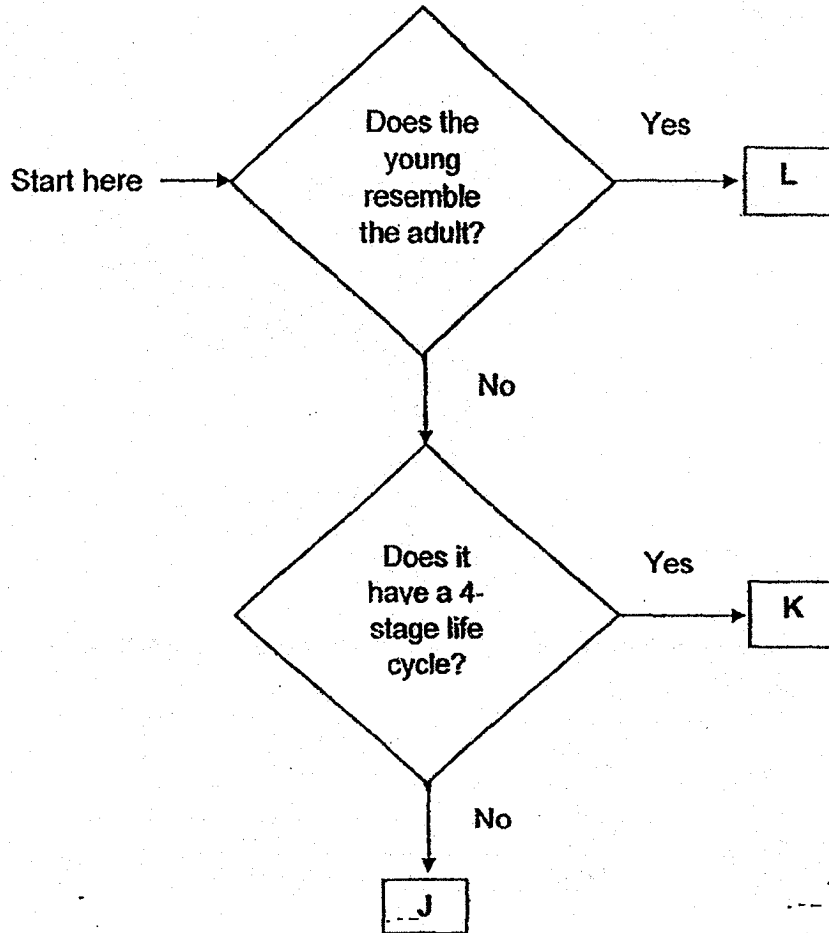

Which of the following represents the life cycle of organisms J, K and L?

	J	K	L
(1)	Butterfly	Cockroach	Chicken
(2)	Frog	Butterfly	Cockroach
(3)	Chicken	Butterfly	Mealworm Beetle
(4)	Frog	Cockroach	Chicken

- 13 Meng Li placed a plant in the dark for 48 hours and then partially covered one of the leaves with black paper. After doing so, he placed the plant under the sun for another 5 hours as shown below.

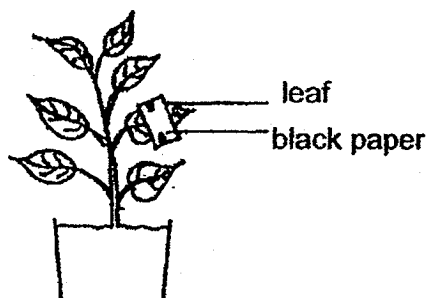

He tested the leaf for starch by using iodine solution and observed the leaf as shown below.

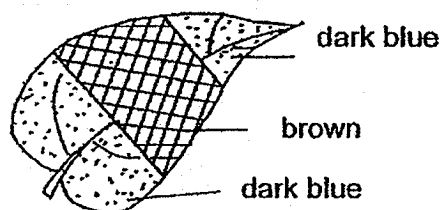

Which of the following can be deduced from the above experiment?

- A: Air is needed for photosynthesis.
- B: Sunlight is needed for photosynthesis.
- C: Chlorophyll is needed for photosynthesis

- (1) A only
- (2) B only
- (3) B and C only
- (4) A, B and C

14 Study the life cycle of a housefly.

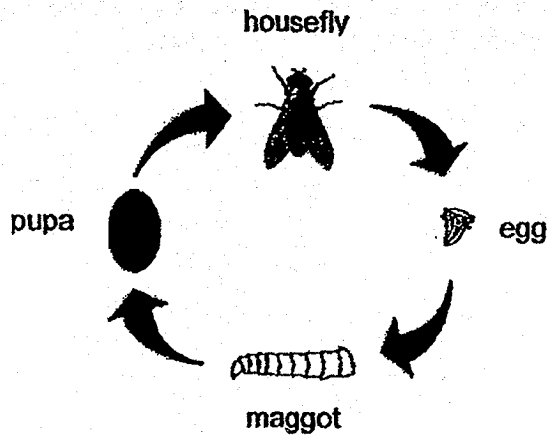

A beaker containing a piece of uncooked meat was left in a room for a week. After a week, maggots were observed on the meat as shown below.

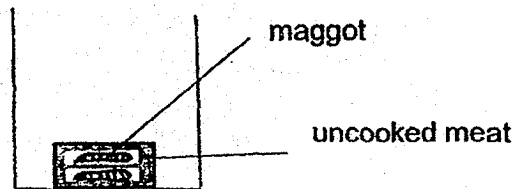

Edina wanted to set up the experiment which would show that the maggots did not come from the meat.

Which set-up should Edina use?

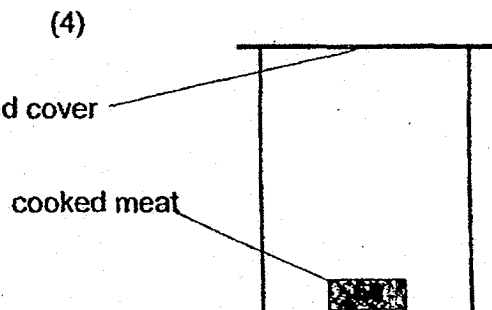
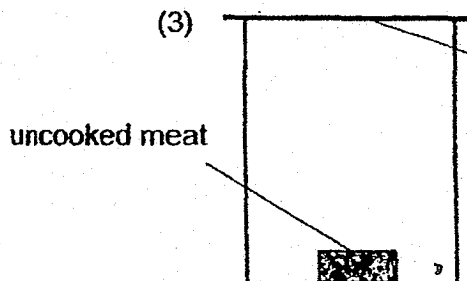
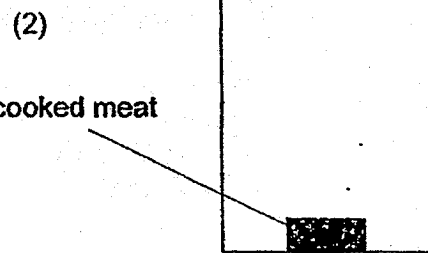
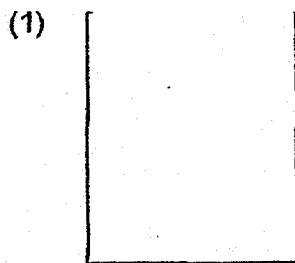

15 Jim noted down the properties of two objects, A and B.

He put a tick (✓) for the property that each object has in the table below.

property	A	B
It is fragile.	✓	
It is flexible.		✓
It is opaque.	✓	✓
It is able to sink in water.	✓	✓

Which one of the following best identifies objects A and B?

	A	B
(1)	metal ruler	rubber band
(2)	newspaper	plastic scissors
(3)	wooden pencil	plastic ruler
(4)	ceramic spoon	rubber boots

16 Bob placed an iron toy car on a board made from three different materials, X, Y and Z, which were glued together. He used a magnet to move the car from point A to point D. However, the car came to a stop at point C.

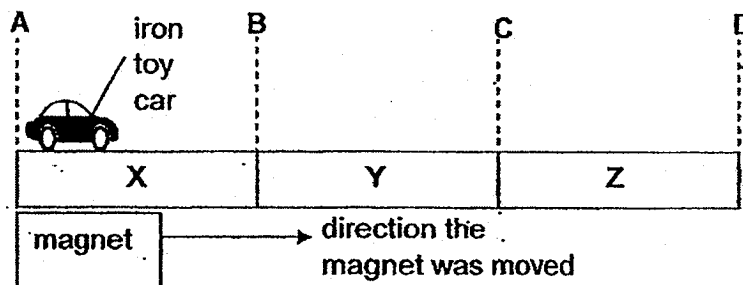

What could materials X, Y and Z be made of?

	X	Y	Z
(1)	iron	copper	plastic
(2)	glass	iron	steel
(3)	copper	plastic	steel
(4)	steel	iron	glass

- 17 Roy threw a ball and it landed in the roof gutter. To find the ball, he attached a mirror to a pole at Point Z.

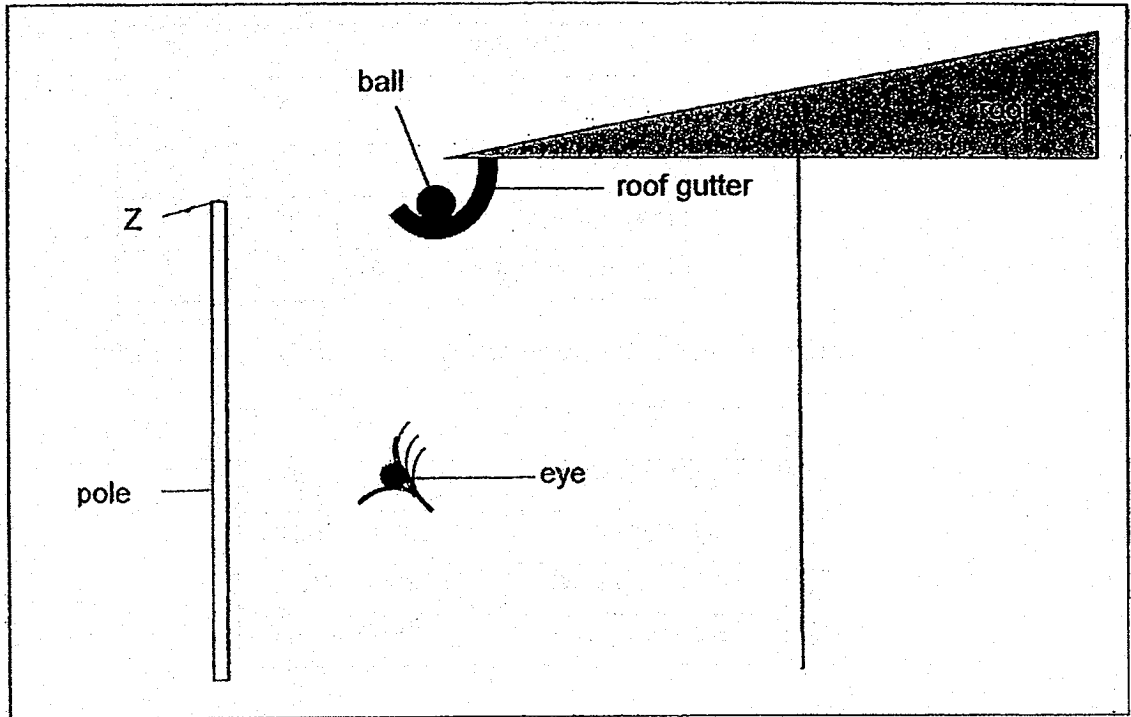

Which one of the following diagrams shows the correct position of the mirror that will allow Roy to see the ball in the gutter?

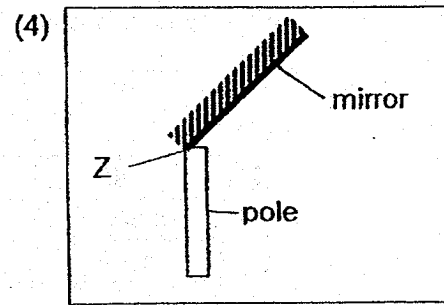
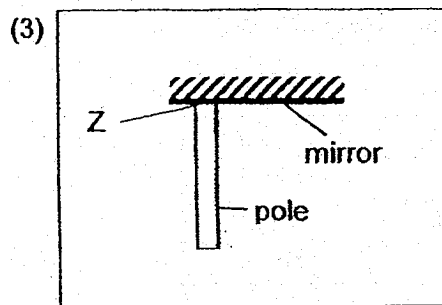
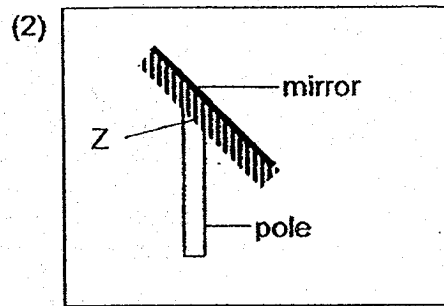
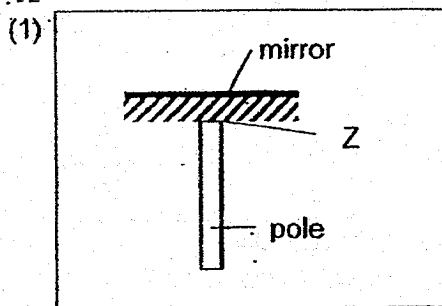

- 18 Martin shone a torch onto two objects, A and B, as shown in the diagram below. Objects A and B were placed at equal distance from the torch.

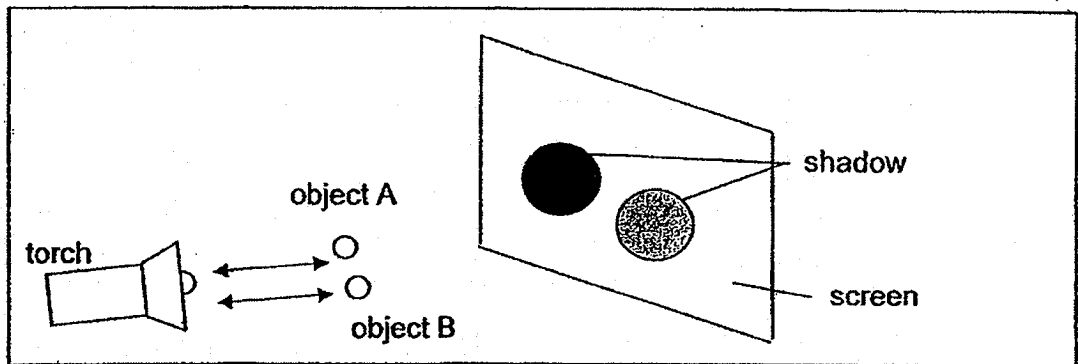

The shadows cast by objects A and B are of similar size but the shadow of object A is darker than the one cast by object B.

Martin wanted the shadow formed to be as shown below.

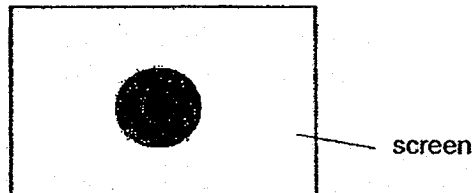

Which one of the following changes should he do before he aligns the objects in a straight line?

- (1) Move object A nearer to the torch
- (2) Move object A nearer to the screen
- (3) Move object B nearer to the screen
- (4) Move objects A and B nearer to the torch

- 19 Study the diagram below. When the plunger is pushed all the way in, all the air from the pump goes into the metal container.

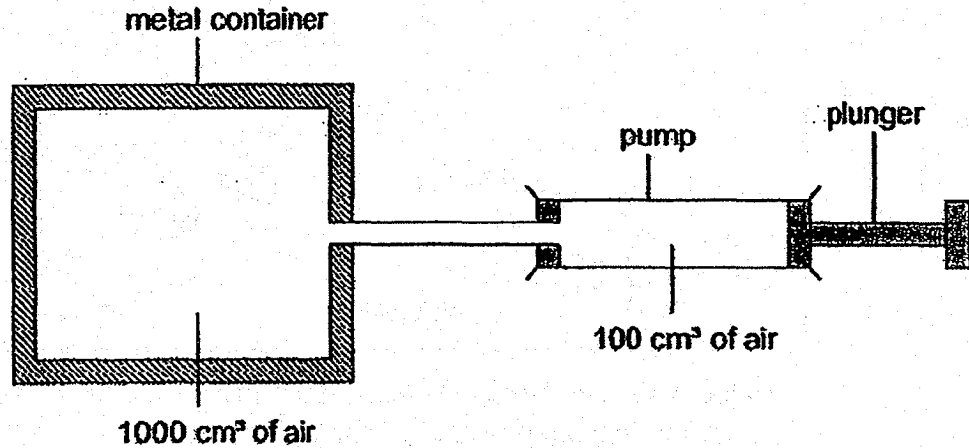

Which one of the following shows what happens to the volume and mass of air in the metal container when the plunger is pushed all the way in?

	Volume of air in the metal container	Mass of air in the metal container
(1)	increases	Increases
(2)	remains the same	remains the same
(3)	remains the same	increases
(4)	Increases	decreases

- 20 Ravi has three objects, A, B and C. He puts object A into a measuring cylinder containing some water. Then he puts object B and then followed by object C. The diagram below shows how the water level changes after each object is placed in.

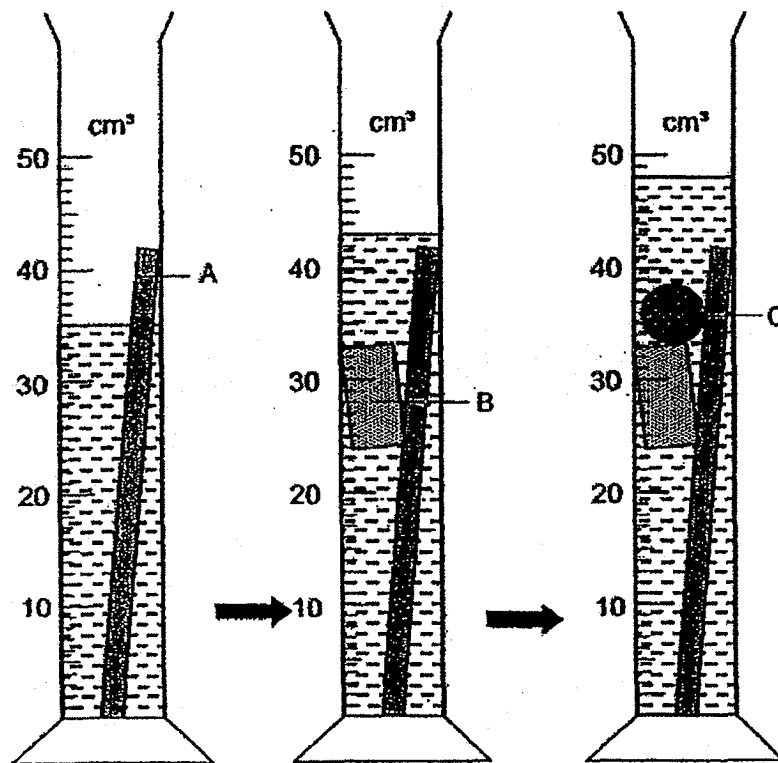

Using only information from the diagram above, Ravi will be able to find the volume of object(s) ___

- (1) C only
- (2) A only
- (3) B and C only
- (4) A, B and C

- 21 In the set-up below, a drop of red ink is placed in the glass tube connecting the two conical flasks, Y and Z. Each flask is then placed in a basin of water at different temperatures.

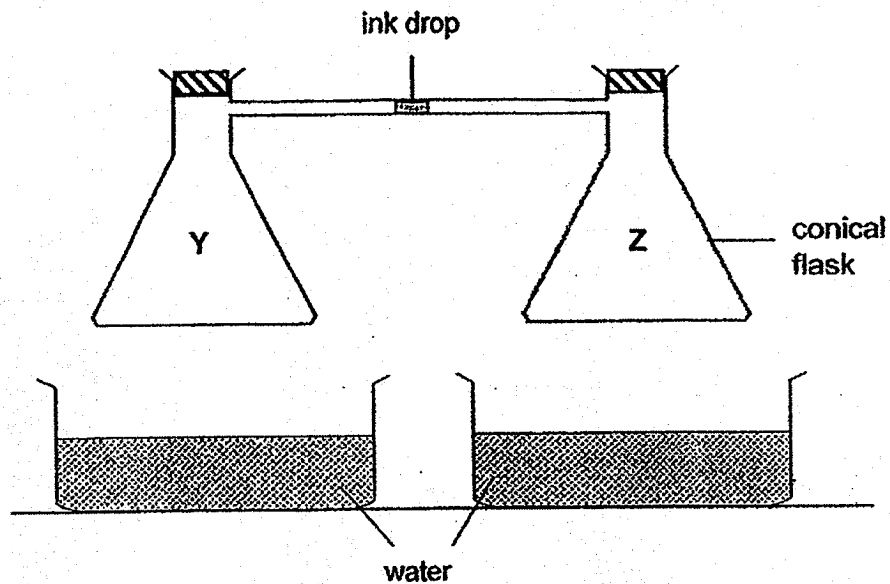

In which one of the following arrangements will the drop of red ink move the furthest from flask Z in the shortest time?

	Temperature of water flask Y is placed in _____	Temperature of water flask Z is placed in _____
(1)	water at 3°C	water at 90°C
(2)	water at 3°C	water at room temperature
(3)	water at room temperature	water at 90°C
(4)	water at room temperature	water at 3°C

- 22 Sue was given a test-tube of water as shown below.

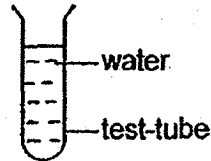

What should Sue do in order to allow the water in the test-tube to take a shorter time to evaporate?

- (1) Remove all fans at the location
 - (2) Put an ice cube into the test-tube of water
 - (3) Seal the mouth of the test-tube with plasticine
 - (4) Transfer all the water from the test-tube to a tray
- 23 Minnie opened the freezer door and observed white 'clouds' escaping from the freezer.

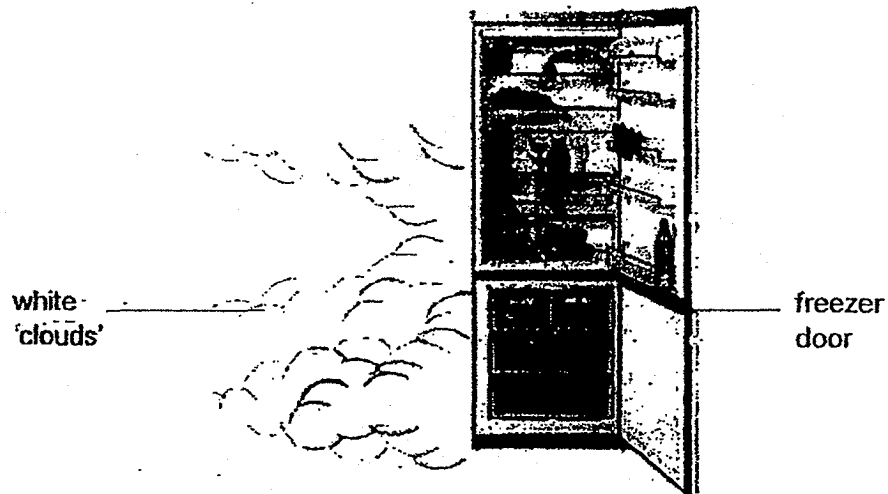

Which one of the following is a true statement about the white 'clouds' seen?

- (1) The 'clouds' seen is steam formed during the process of condensation.
- (2) Water droplets from in the refrigerator evaporated to form the 'clouds'.
- (3) Water vapour from the cold air lost heat to the warmer surrounding air and condensed to form the 'clouds'.
- (4) Warmer water vapour from surrounding air lost heat to the cold air and condensed to form the 'clouds'.

- 24 The diagram below shows an electric circuit with four identical bulbs, A, B, C and D, and four switches, S1, S2, S3 and S4.

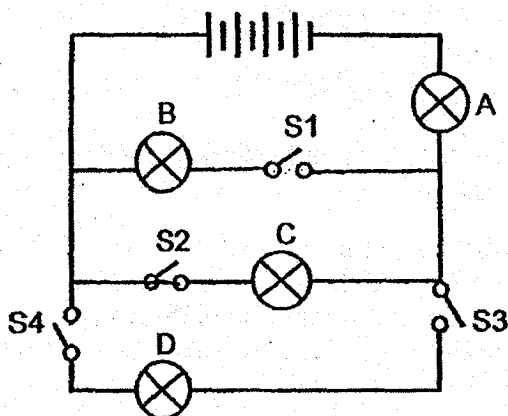

What is the least number of switches that must be closed to light up bulbs A and C?

- (1) 1
 - (2) 2
 - (3) 3
 - (4) 4
- 25 The circuit diagram below shows how the various components are connected together.

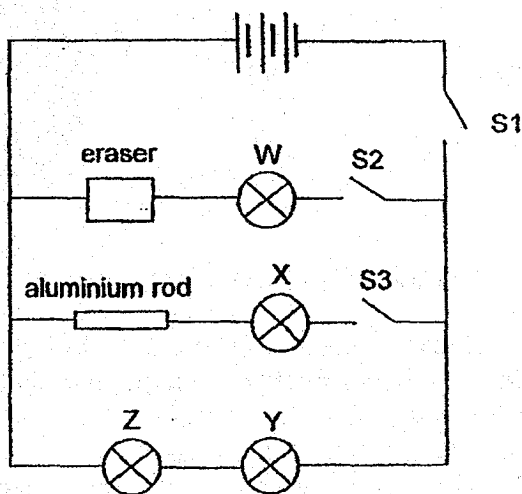

Which one of the following observations is correct?

- (1) When only S1 and S2 were closed, bulb W was lit.
- (2) When only S1 was closed, all the bulbs were lit.
- (3) When only S3 was closed, bulbs X, Y and Z were lit.
- (4) When only S2 and S3 were closed, none of the bulbs lit up.

- 26 The diagram below shows 4 cubes of equal mass supported in different ways. Cubes A and C are hung from a support while B and D are balanced on their support.

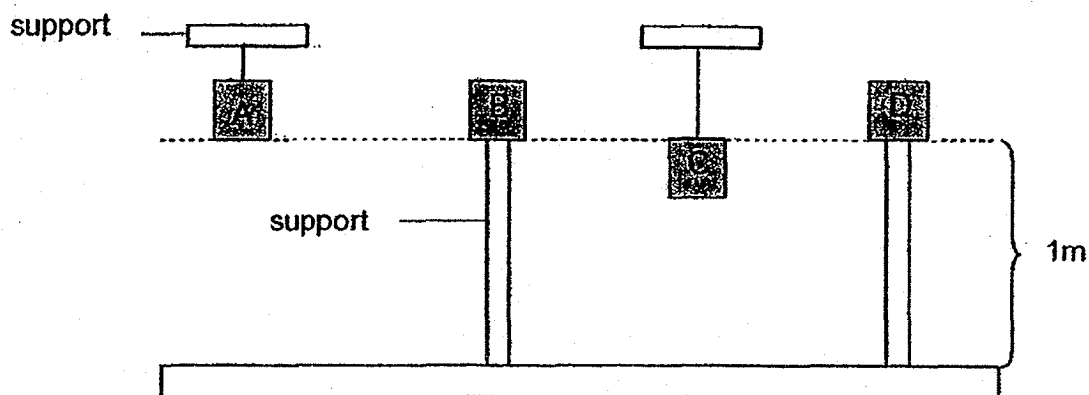

Which one of the following statements is true about the amount of gravitational potential energy the cubes possess?

- (1) A is equal to B
 - (2) A is greater than B
 - (3) C is greater than D
 - (4) All the cubes have the same amount
- 27 When Aziz jumped on the trampoline, he noticed that there was a force which pulled him downwards and then another force which pushed him upwards.

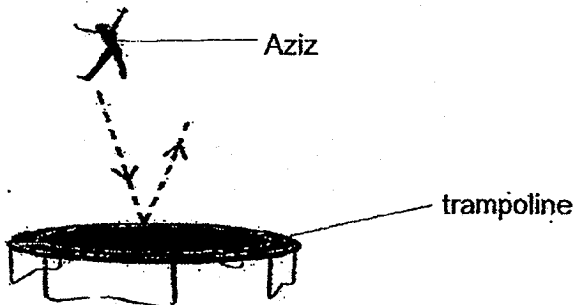

Identify the forces which pulled him downwards and pushed him upwards respectively.

	Force which pulled him downwards	Force which pushed him upwards
(1)	Elastic Spring Force	Magnetic Force
(2)	Gravitational Force	Gravitational Force
(3)	Gravitational Force	Elastic Spring Force
(4)	Frictional Force	Gravitational Force

- 28 Four identical balls, W, X, Y and Z, were hung from a pole using strings of different lengths as shown in the diagram below.

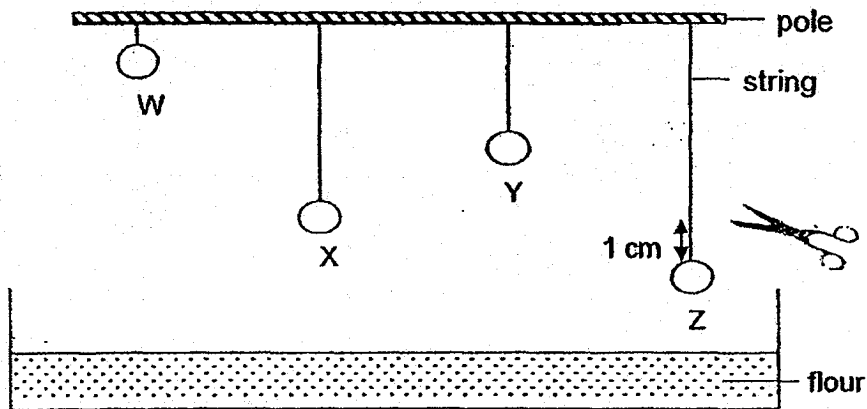

Each string was cut 1 cm above each ball. The balls landed in a container of flour placed directly below. Four dents of different depths were created in the flour by the four balls.

Which one of the following diagrams shows correctly the four dents in the flour made by the four balls respectively?

- (1)
- (2)
- (3)
- (4)



Rosyth School
Preliminary Examination 2018
SCIENCE
Primary 6

Total
Marks:

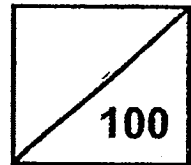

Name:

Class: Pr 6

Register No.

Duration: 1 h 45 min

Date: 24 Aug 2018

Parent's Signature:

Booklet B

Instructions to Pupils:

1. For questions 29 to 40, give your answers in the spaces given in Booklet B.

	Maximum	Marks Obtained
Booklet A	56 marks	
Booklet B	44 marks	
Total	100 marks	

* This booklet consists of 17 printed pages (including cover page).

This paper is not to be reproduced in part or whole without the permission of the Principal.

Part II

For questions 29 to 40, write your answers in the space provided. (44 Marks)

29 A group of scientists studied the mass of similar type of dead leaves at two places M and N. Process A took place and the mass of leaves decreased over a period of five weeks. The results are as shown below.

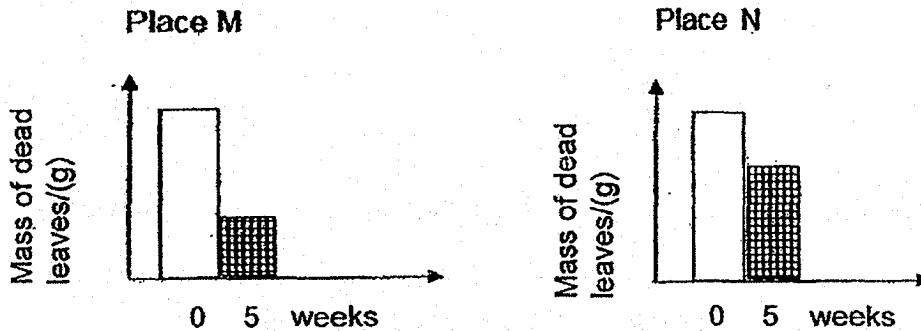

(a) Name the process A. [1]

The mass of dead leaves decreased in both places over the period of 5 weeks

(b) Explain how a physical factor in the environment has caused a difference in the decrease of mass of the dead leaves in the two places M and N. [2]

(c) Other than process A, evaporation could also cause the decrease in the mass of dead leaves. Explain why. [1]

30 David read about an animal P in his book.



(a) Animal P is a mammal. State a physical characteristic that helped to classify it as a mammal. [1]

Animal P lives near a river. The young of animal P are born in a burrow under the ground as shown below.



(b) Suggest why is it an advantage for survival of the young. [1]

Animal P spends most of its time in water. It usually keeps its feet above water as shown below. David predicted that this behaviour is to keep itself warm in a very cold water.

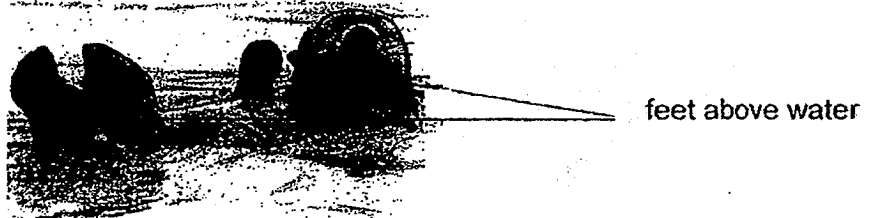

Question 30 is continued on page 4

To prove his prediction, David conducted an experiment using set-ups A and B as shown below. A and B are double glass beakers, A filled with air in-between while B is filled with water. Both beakers filled with hot water at 80°C as shown below.

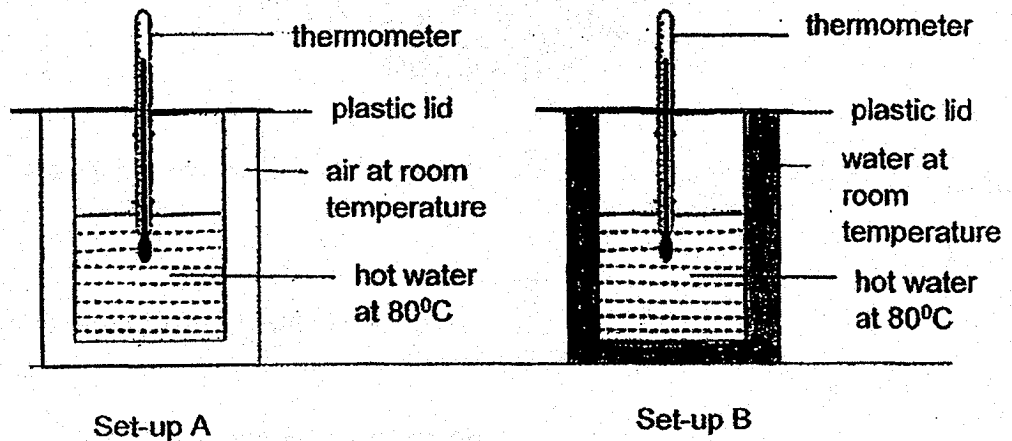

David measured the temperatures of the hot water in the beakers at different times and plotted his results in the graph shown.

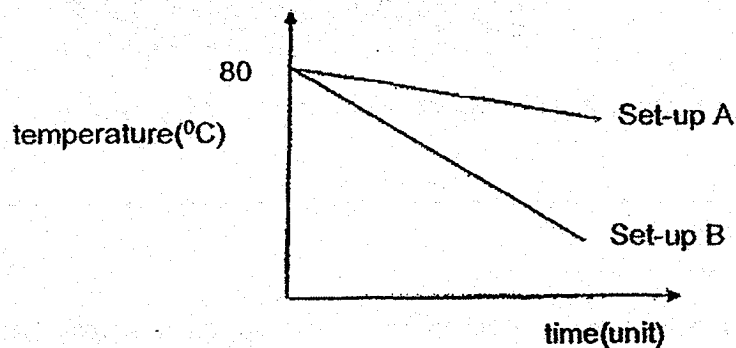

- (c) Based on the graph, what is the relationship between the temperature of hot water and time? [1]

- (d) Using the results, explain how animal P keeps itself warm by putting its feet above water [1]

31 Plant X floats on the surface of a pond as shown below.

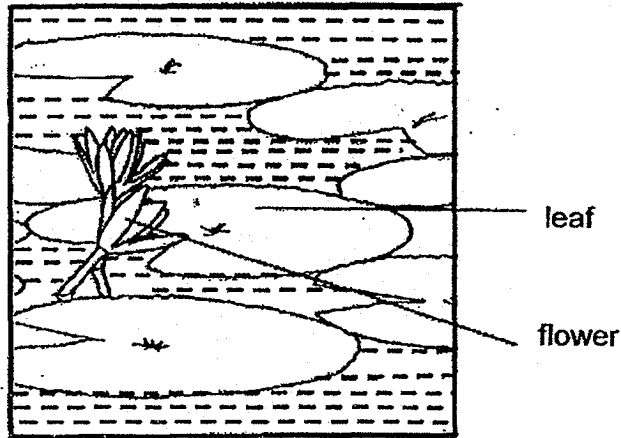

(a) Devi noticed that flowers of plant X were above the water. How does this characteristic help plant X in its reproduction? [1]

(b) Complete the boxes below to state the other part and process involved for flowers of plant X to become fruits. [2]

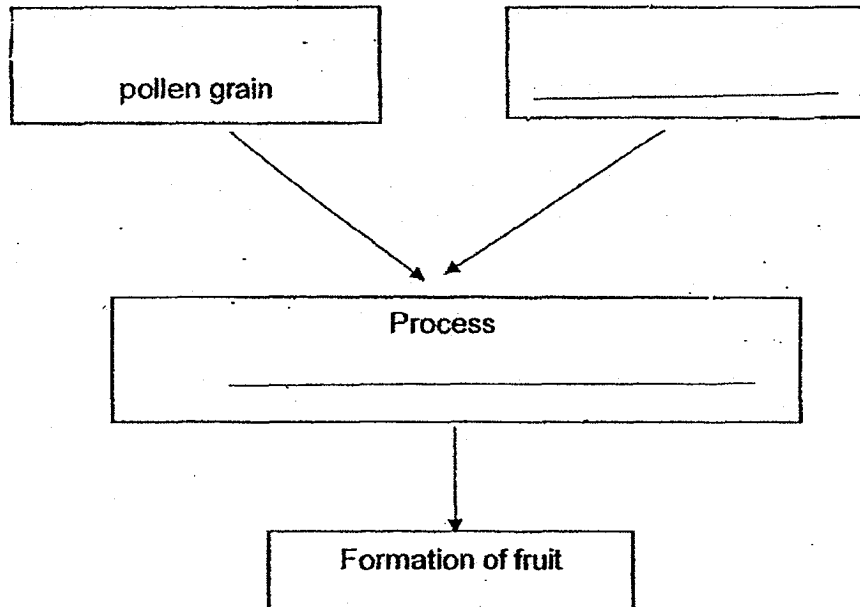

(c) Fruits help to protect the seeds inside. State another function of fruits. [1]

- 32 Wen Hui wanted to find out if oxygen is released by a water plant during photosynthesis. He set up an experiment as shown in the diagram below in a lit room.

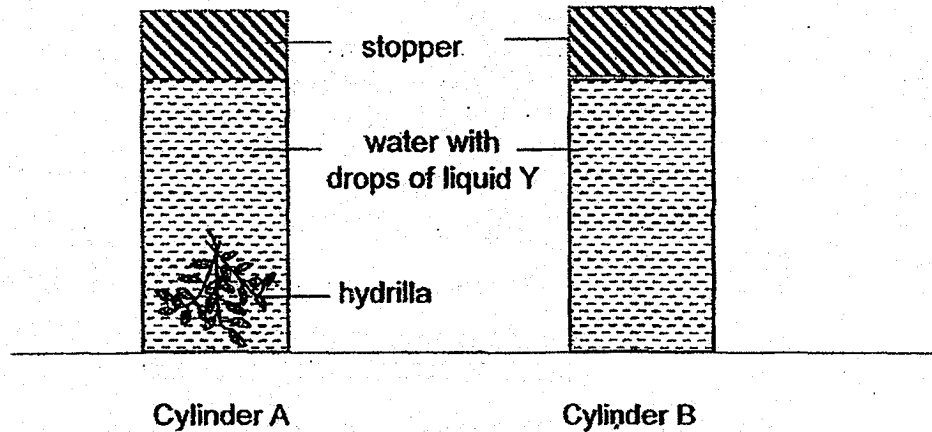

Liquid Y is used as an indicator of oxygen. It turns from blue to red when the amount of oxygen increases. The indicator was blue at the start of the experiment.

- (a) Why was the experiment conducted in a lit room? [1]

- (b) Wen Hui's friend said that Cylinder B was not needed for his experiment. Do you agree with his friend? Explain why. [1]

- 33 Rina measured the amount of undigested food in each part of a human digestive system just before it entered the next part. She wanted to show the comparison of undigested food between the mouth and gullet using a graph. She drew two graphs, X and Y, as shown below.

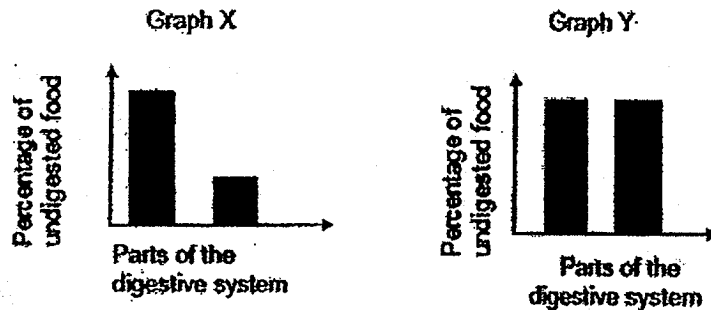

- (a) Which graph X or Y represents the comparison between the mouth and gullet correctly? Give a reason. [1]

- (b) Besides the mouth and small intestine, which other part of the human digestive system produces digestive juice? [1]

Study the food chain shown below.



Adult female insect M is always filled with fertilised eggs. The eggs are not digestible.

- (c) Using the information above, describe what would happen to the insect and the eggs in the bird's digestive system starting from the small intestine. The digestive system in the bird is similar in function to the human digestive system. [2]

Insect: _____

Eggs: _____

Birds feed on many insects M before migrating to another place.

- (d) How does Insect M benefit from this relationship? [1]

34 Recent studies have shown that there is a large amount of microscopic plastics known as micro-plastics in oceans.

(a) Name the type of pollution. State one way to reduce it. [2]

Study the food chain in a habitat.

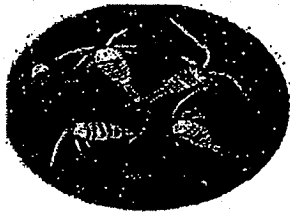

micro-plastics present alongside with microscopic organisms

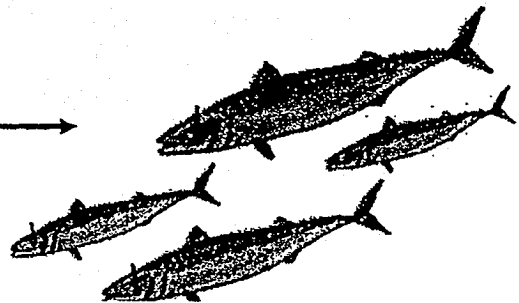

fish R feeds on the micro-plastics present alongside with microscopic organisms

Animal S lives in the same habitat as the fish. A marine scientist found micro-plastics in the stomach of animal S.

(b) State a possible relationship between the fish R and animal S in the above food chain. [1]

35 Reflective studs are used to mark roads in unlit areas as shown below.

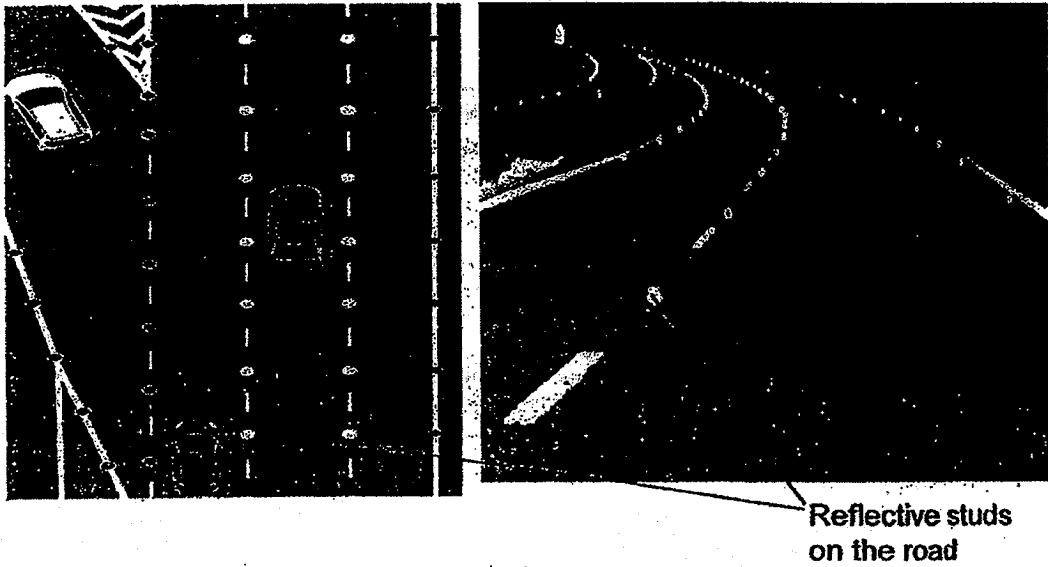

Ahmad conducted an experiment with four different materials, A, B, C and D. He used a light sensor to determine the amount of light that was reflected by the materials from the light source at various distance. He recorded the results in the graph below.

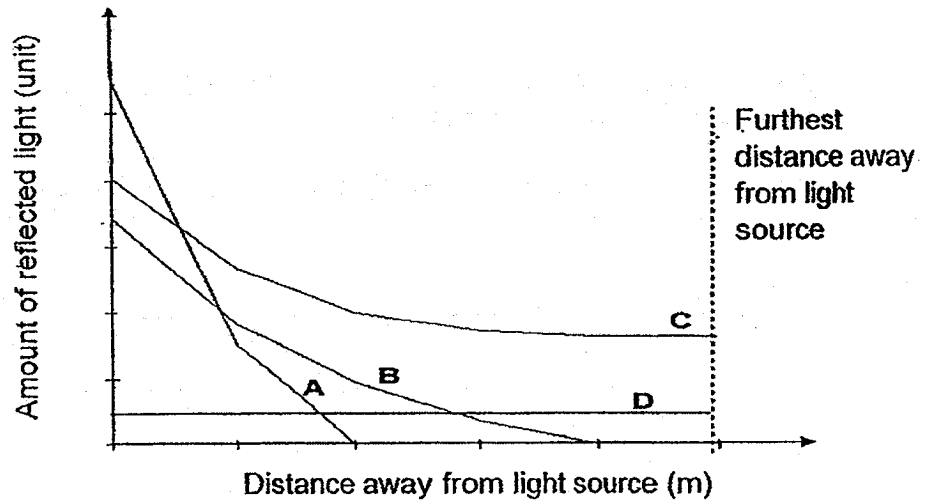

Question 35 is continued on page 11

- (a) Using the results, which material is most suitable for making the reflective studs? Explain why. [2]

- (b) Draw the pathway of light using arrows (→) to show how light travels to enable driver of a car to see the lit reflective stud on the road in the diagram below. [1]

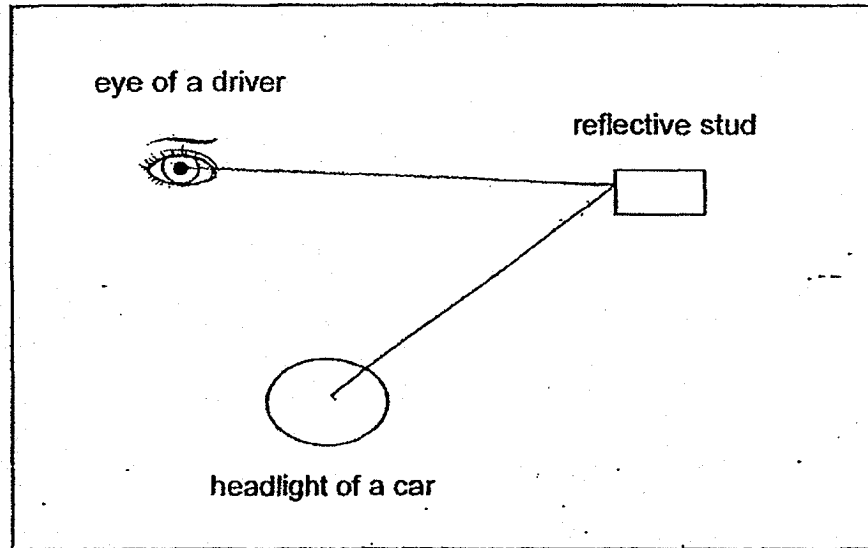

- 36 Jane wanted to conduct an experiment to find out if the surface area of a block of frozen meat in contact with material A affects its rate of melting to defrost the meat.

In her experiment, she used two similar frozen meat blocks and two similar trays of Material A. Material A is a good conductor of heat. She left both set-ups by the window and recorded the time taken for each frozen meat block to defrost completely.

The possible set-ups of her experiment are shown below.

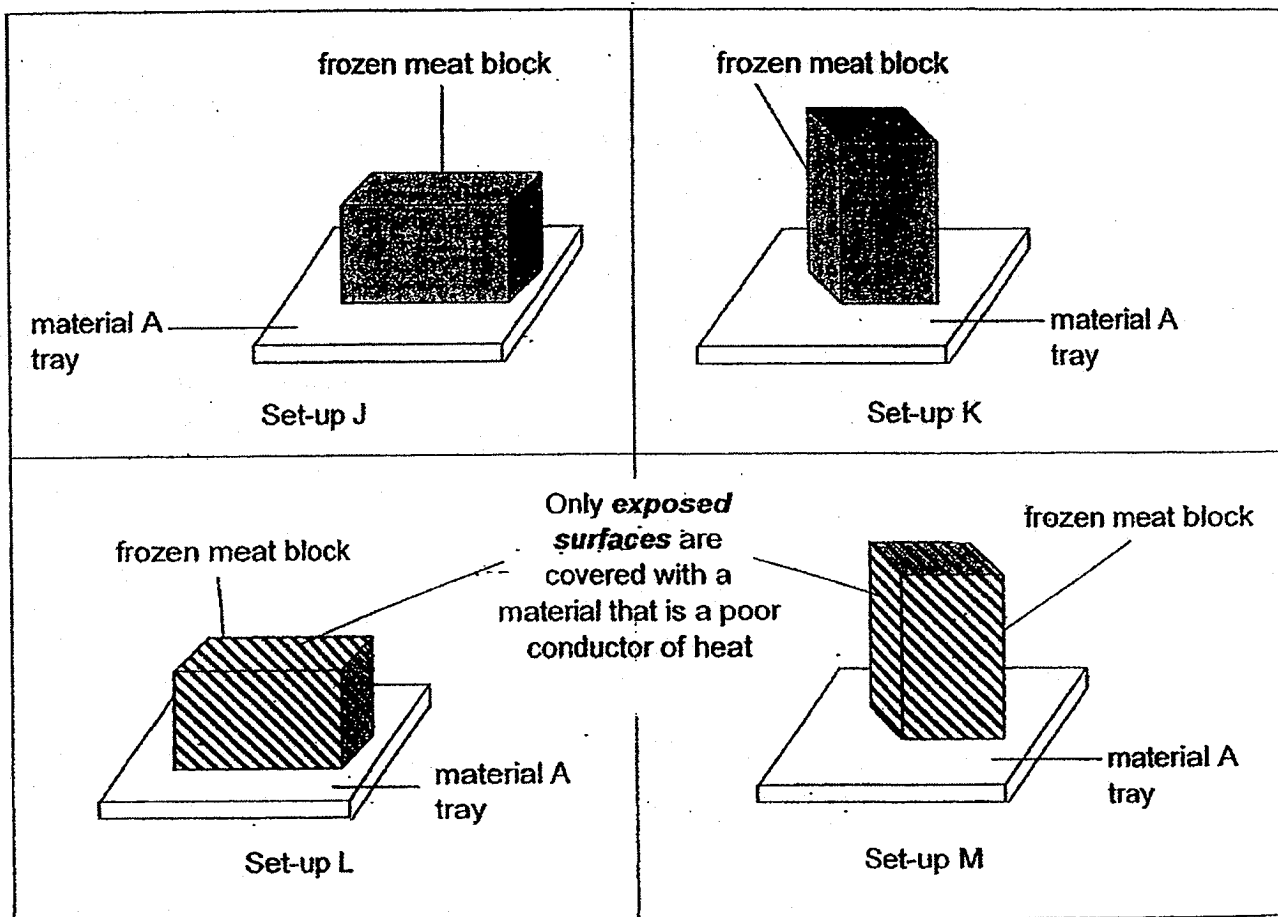

- (a) Which two set-ups, J and K or L and M should Jane use to carry out a fair experiment? [1]

Set-ups _____ and _____

Question 36 is continued on page 13

(b) Explain your choice in (a). [2]

(c) Suggest a material that can be used to cover the exposed surface areas of frozen meat blocks in set-ups L and M. [1]

(d) Jane then carried out another experiment to determine how well heat is conducted through tray materials A and B. She obtained the results as shown in the table below.

Material of tray	Time taken for ice block to melt completely / min
Material A	56
Material B	34

Based on the results shown above, what conclusion can Jane make about how materials A and B conduct heat? [1]

- 37 A beaker of solid substance W was heated on a stove till it melted at B. Heating continued for some time and then it was removed from the stove to cool on a table. The graph below shows the change of temperature of substance W over the period of time.

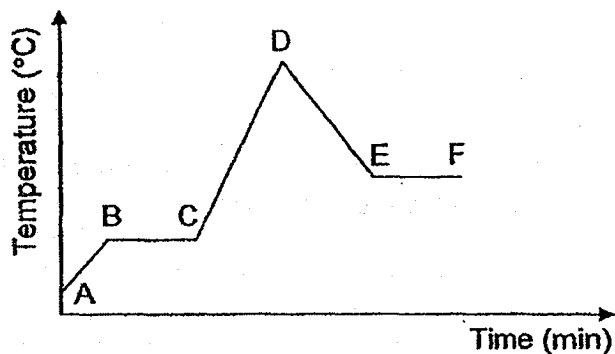

Based on the information above, put a tick (✓) in the correct box for each statement.

[4]

	True	False	Not possible to tell
(a) From points B to C, substance W is gaining heat.			
(b) At D, substance W reaches its boiling point.			
(c) Substance W takes the shape of the beaker from points D to E.			
(d) From points E to F, substance W loses heat and freezes.			

- 38 The diagram below shows a circuit. The table shows what happens to the light bulb when four different rods A, B, C and D are connected one at a time to the contact points X and Y.

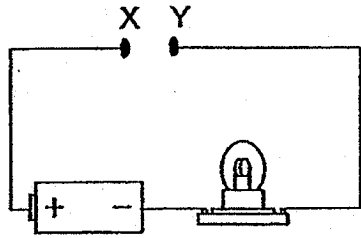

Rod that connects X and Y	Did the bulb light up?
A	yes
B	no
C	no
D	yes

- (a) What can be said about the rods A, B, C and D from the results above? [2]

In another experiment, the same four rods A, B, C and D were placed at different positions S1, S2, S3 and S4 in the following circuit.

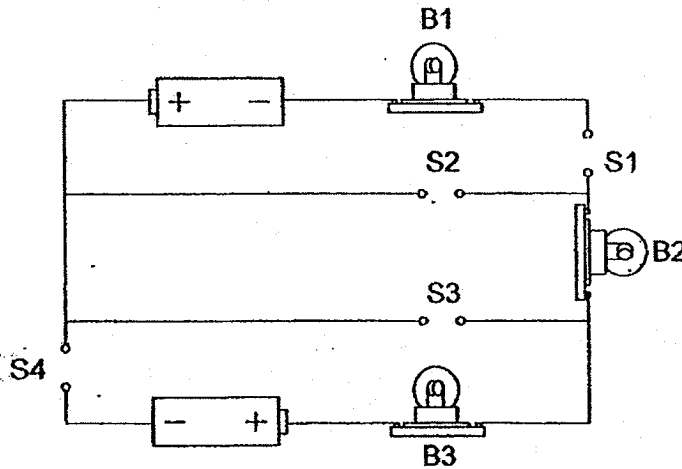

- (b) Complete the following table. Put a tick (✓) in the box to show that the bulb lit up. [1]

Position where each rod was placed				Bulbs		
S1	S2	S3	S4	B1	B2	B3
rod B	rod D	rod C	rod A			

- 39 The diagram below shows a water turbine found in a hydroelectric power station. When the tap is turned on, water flows down from the water pipe and gushes out through the nozzle. The gushing water in turn causes the blades of the turbine to spin which then generates electricity in the generator.

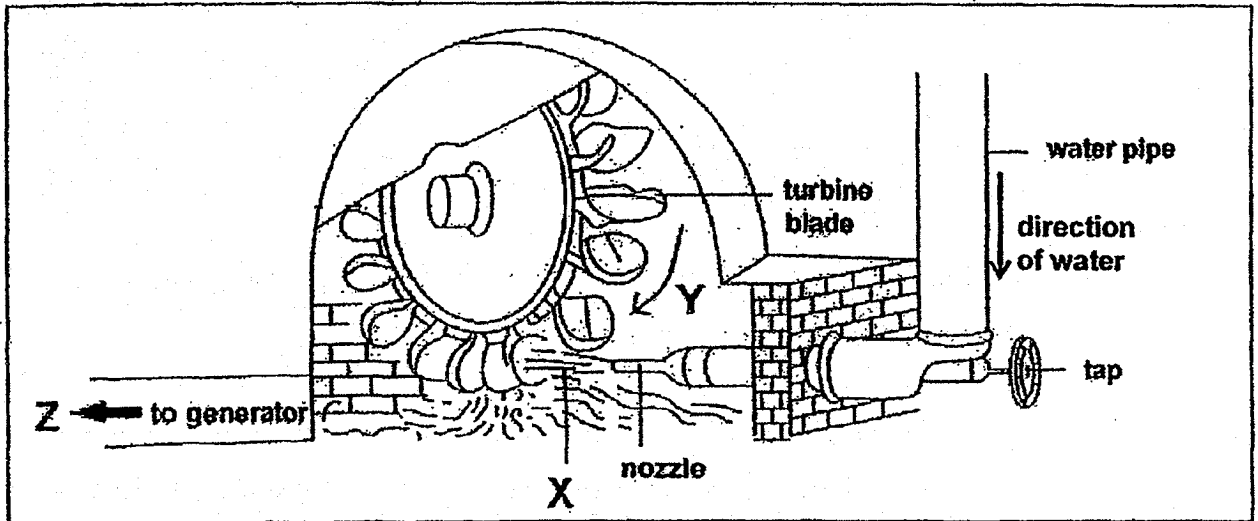

- (a) State the useful energy changes that take place in the set-up above to generate electrical energy. [1]

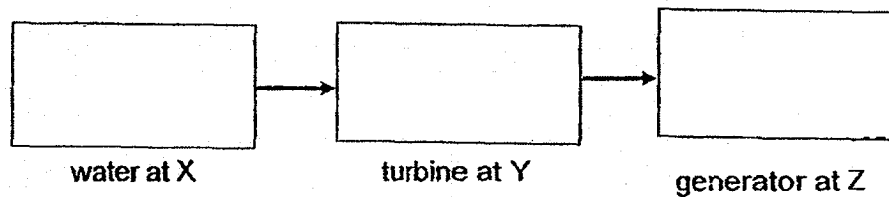

- (b) Draw the graph to show the relationship between the speed of water (unit/min) that passes through the pipe and the rate of spinning turbine (unit/min). [1]

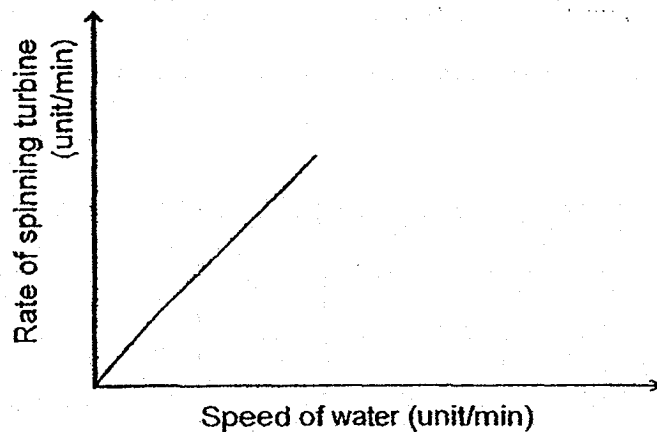

40 The diagram below shows a floating dining table.

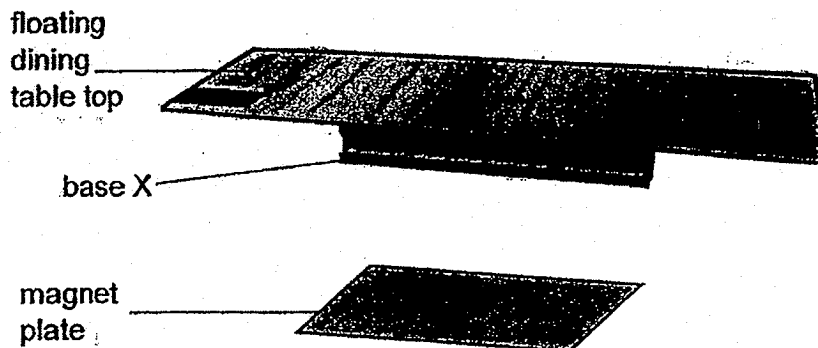

The floating dining table consists of a magnet plate on the floor and a special base X. Base X must be present in order for the table top to float.

(a) Identify what base X is. [1]

(b) Describe how the dining table is able to float. [2]

It is not recommended to place items with a total mass of greater than 150kg on the table top as it will not be able to float.

(c) Why does the dining table not float when the mass placed on it is greater than 150 kg? [1]

(d) Suggest a way that would allow the table top to float while holding items with a mass greater than 150kg.

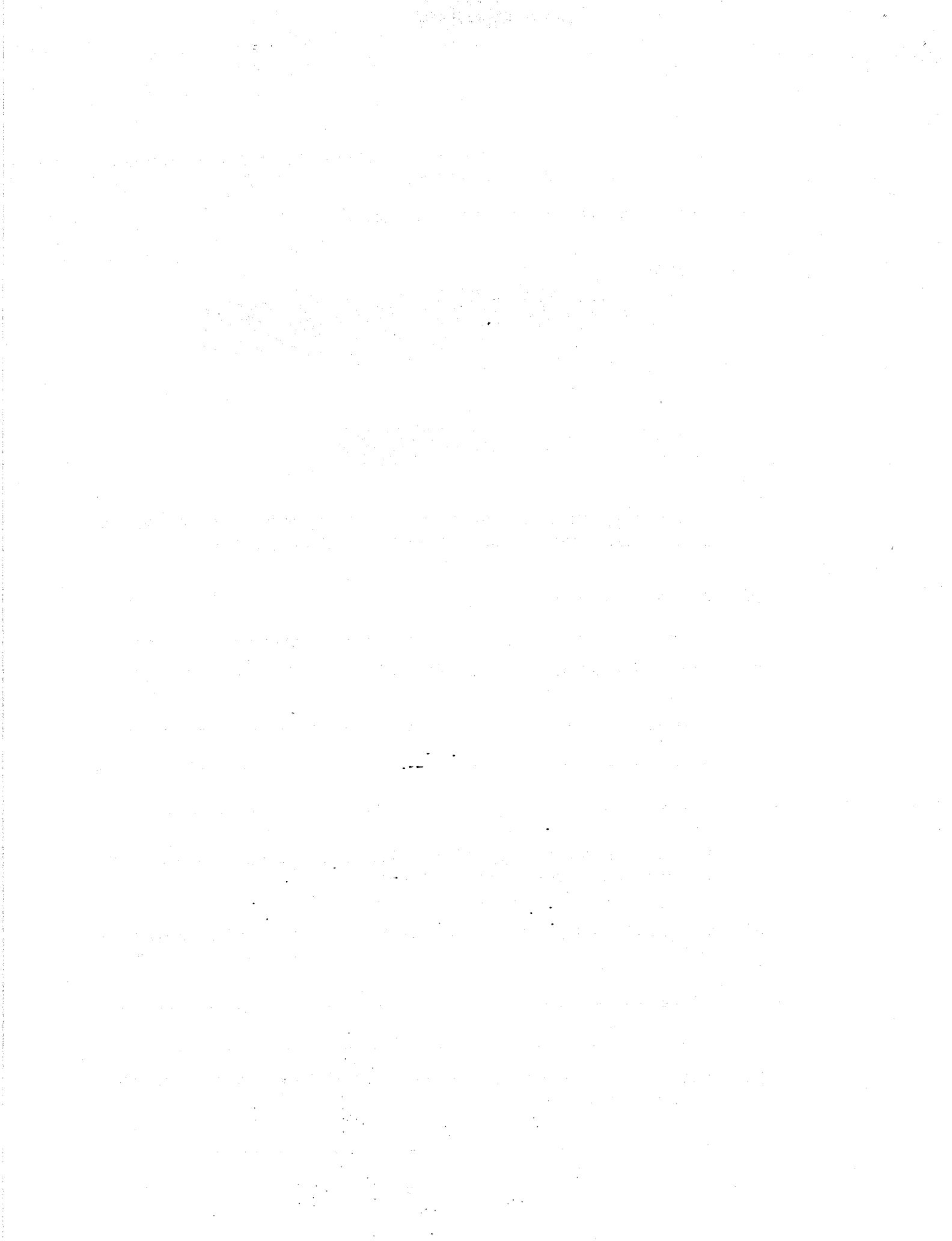

YEAR : 2018
LEVEL : PRIMARY 6
SCHOOL : ROSYTH SCHOOL
SUBJECT : SCIENCE
TERM : PRELIMINARY EXAMINATION

BOOKLET A

Q1	4	Q2	4	Q3	2	Q4	1	Q5	3
Q6	4	Q7	3	Q8	2	Q9	3	Q10	3
Q11	2	Q12	2	Q13	2	Q14	3	Q15	4
Q16	3	Q17	4	Q18	2	Q19	3	Q20	1
Q21	1	Q22	4	Q23	4	Q24	1	Q25	4
Q26	1	Q27	3	Q28	1				

BOOKLET B

Q29a) Decomposition

Q29b) Place M may have contained more moisture than Place N, causing the leaves to decompose faster, hence the difference in mass of dead leaves in both places.

Q29c) The dead leaves contain water that contributes to overall mass. The water in the leaves can gain heat from the surroundings and then evaporate, causing the leaves to lose the water, and the mass of it.

Q30a) It has hair.

Q30b) It is harder for the predators of the young of animal P to find them and feed on them.

Q30c) As the time increases, the temperature of hot water in set-ups A and B decreases.

Q30d) The temperature of hot water in set-up B was cooler than that of set-up A at the end of the experiment. This shows that water is a better conductor of heat than air. So by putting its feet above water, it will lose heat to the water at a slower rate, allowing P to keep itself warm.

Q31a) The flowers will be more visible to animal pollinators if above water, allowing pollination to occur more frequently.

Q31b) Ovule, Fertilisation

Q31c) To help disperse the seeds.

Q32a) This allows photosynthesis to take place as the plant needs light to do so.

Q32b) No. Cylinder B is a control set-up that will confirm that the only variable affecting the colour of liquid Y is the occurrence of photosynthesis.

Q33a) Y. It shows that the percentage of undigested food that left the mouth and gullet remained the same. Digestion does not occur in the gullet, hence Y is correct.

Q33b) Stomach.

Q33c) The insect will be digested and broken down into simpler substances and then absorbed by the small intestines into the bloodstream.

The eggs will be passed into the large intestines and then passed out along with the bird droppings as they are not digestible.

Q33d) Migration helps to disperse the eggs to further places, ensuring more space covered. This gives the eggs more food to survive.

Q34a) Water pollution. Do not throw litter into the sea.

Q34b) Animal S is the predator of fish R.

Q35a) Material C. Material C showed it reflected the most amount of light from the furthest distance. This is ideal because it means that drivers can notice the reflected lights from far away and this will ensure better road safety.

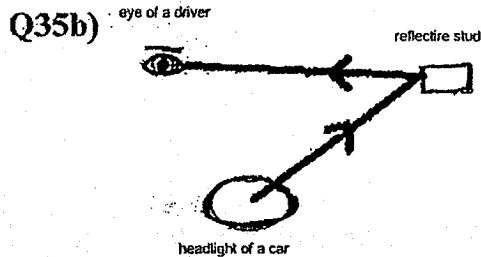

Q36a) Set-ups L and M

Q36b) By choosing both set-ups, the only variable affecting the result is the surface area of the block in contact with A. The exposed surface areas are covered with a poor conductor of heat to ensure most heat gain is largely due to the surface area in contact with A. This perfectly represents the objective.

Q36c) Rubber

Q36d) B is a better conductor of heat than A.

Q37) a: True

b: Not possible to tell

c: True

d: False

Q38a) A and D are conductors of heat but B and C are not.

Q38b) Bulbs B2 and B3

Q39a) kinetic energy \rightarrow kinetic energy \rightarrow Electrical energy

Q39b)

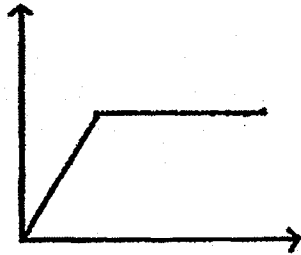

Q40a) Magnet

Q40b) Base X is a magnet with its like poles facing the magnet. Since like poles repel, base X was repelled by the magnet plate, and the magnetic force is stronger than the gravitational pull, allowing the table to float.

Q40c) When 150kg is added to the table, the magnetic force is unable to overcome the gravitational pull as the gravitational force has increased due to additional mass.

Q40d) Replace the current magnet with a stronger one.