

ANGLO-CHINESE SCHOOL
(JUNIOR)



SEMESTRAL ASSESSMENT 2 (2012)
PRIMARY 5

SCIENCE

BOOKLET A

Tuesday

30 Oct 2012

1 hour 30 minutes

Name : _____ ()

Class : P5 _____

INSTRUCTIONS TO PUPILS

DO NOT TURN OVER THE PAGES UNTIL YOU ARE TOLD TO DO SO

Follow all instructions carefully.

There are 25 questions in this booklet.

Answer **ALL** questions.

INFORMATION FOR PUPILS

The total marks for this booklet is 50.

The total time for Booklets A and B is 1 hour 30 minutes.

This question paper consists of 14 printed pages. (Inclusive of cover page)

For each question from 1 to 25, four options are given. One of them is the correct answer. Make your choice (1, 2, 3 or 4). Shade your answer on the Optical Answer Sheet.

(50 marks)

1 Aaron wanted to find out which material, glass or plastic, was harder. He then used two identical objects made of the two different materials to carry out the test. Which of the following should he do to test the hardness of the materials?

- (1) Bend the objects.
- (2) Scratch the objects with a nail.
- (3) Drop the objects from a height.
- (4) Place the objects in a tank of water.

2 Which of the following is **not** true of fungi?

- (1) Fungi grow in humid places.
- (2) Fungi reproduce by spores and seeds.
- (3) Fungi feed on plants and animals, dead or alive.
- (4) Fungi break down their food into substances that they can absorb

3 Andrew listed the similarities between the life cycle of a butterfly and a housefly.

- A Their young eat a lot at the pupa stage.
- B They have the same number of stages.
- C Their young look different from their adult.
- D Their young live in a different environment from their parents.

Which statement(s) is/are correct?

- (1) A and C only
- (2) B and C only
- (3) B and D only
- (4) A, C and D only

4 Which of the following is/are true about snow, water and/or steam?

- A All have definite volume.
- B Snow has definite shape.
- C They are in different states of matter.
- D Steam and water are in the same state.

- (1) A and C only
- (2) B and C only
- (3) A, B and D only
- (4) B, C and D only

- 5 Arthur places Cube Z into Beaker Y, filled with Liquid X, as shown in the diagram below.

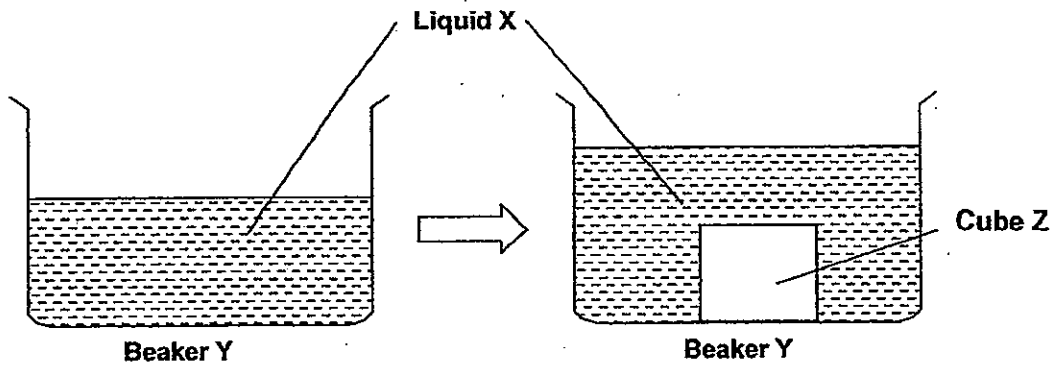

Based on the experiment above, Arthur listed the following observations.

- A Cube Z has a definite shape.
- B Cube Z has no definite mass.
- C Liquid X has no definite shape.
- D Liquid X has a definite volume.

Which of his observations is/are correct?

- (1) A and C only
 - (2) B and D only
 - (3) A, C and D only
 - (4) A, B, C and D
- 6 The diagram below shows some parts of a flower.

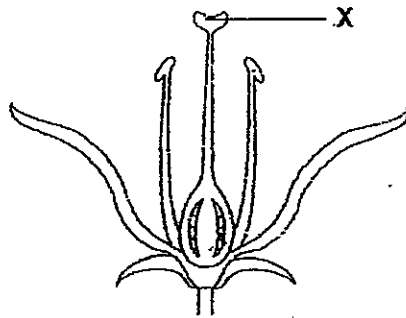

What is the function of the part labelled 'X'?

- (1) Helps to attract birds or insects for pollination.
- (2) Contains ovules where each ovule will develop into a seed
- (3) Protects the seed from the insects as it develops into a fruit.
- (4) Allows pollen grains to land on it for pollination to take place.

7 The following shows some characteristics of a child.

- A Dimples
- B Curly hair
- C Long finger nails
- D Detached ear lobe

Which of the characteristics could the child have inherited from his/her parents?

- (1) C and D only
- (2) A, B and C only
- (3) A, B and D only
- (4) A, B, C, D

8 The diagram below shows the human reproductive parts.

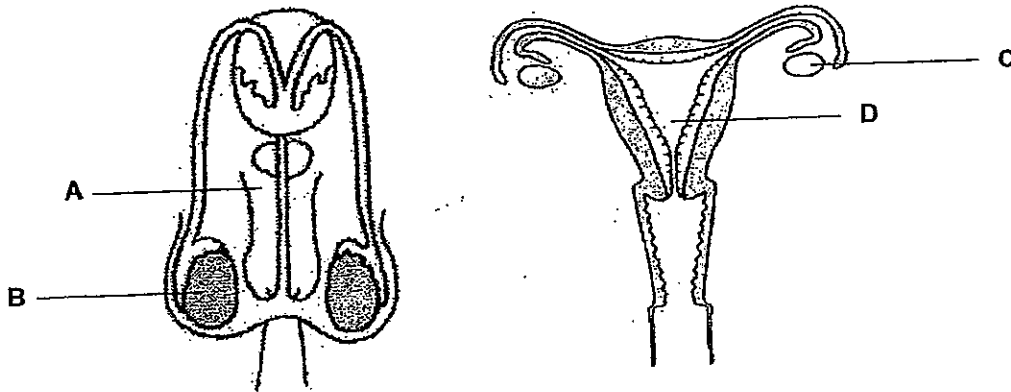

Which parts of the systems produce the reproductive cells?

- (1) A and C only
- (2) A and D only
- (3) B and C only
- (4) B and D only

9 Brandon wanted to help his family to reduce the water consumption at home. Below are the observations of the activities carried out by his family members.

- Mother: Water used to wash the vegetables was used to water the plants.
- Brother: Used a pail of water to clean his bicycles and soccer boots.
- Sister: Used the washing machine to wash a pair of jeans.
- Father: Washed the car with a hose.

Who did not help to conserve water at home?

- (1) Father and Sister
- (2) Mother and Sister
- (3) Brother and Father
- (4) Mother and Brother

- 10 A beaker of ice cold water was placed on a table in an air-conditioned room for one hour. Which of the following will take place during that period of time?

- A The water loses heat
- B Evaporation will take place.
- C The temperature of water remains the same.
- D Water droplets will form on the outer surface of the beaker.

- (1) A and C only
- (2) A and D only
- (3) B and C only
- (4) B and D only

- 11 Tim attached Magnet A to a spring and let it hang as shown in Diagram 1. He then placed Magnet B directly below Magnet A as shown in Diagram 2 below.

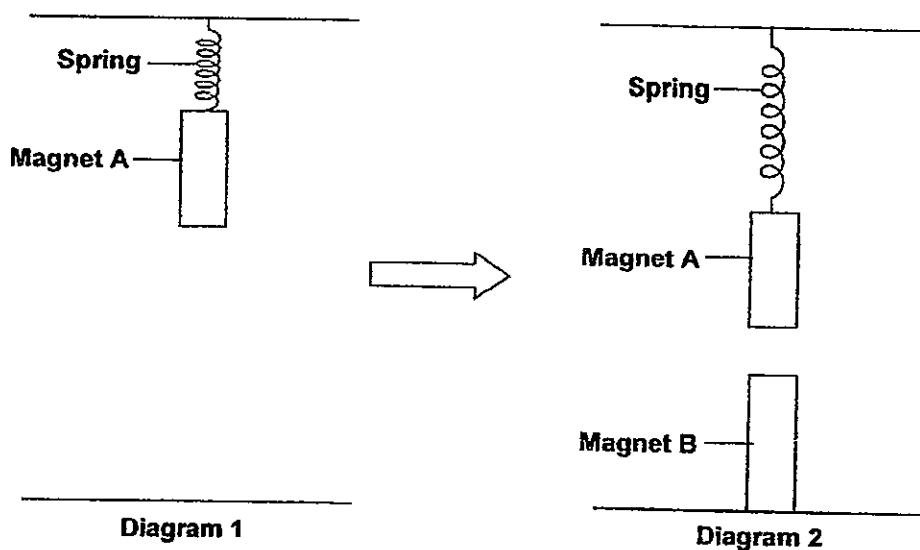

Which of the following could be the reason for the spring to stretch in Diagram 2?

- (1) Magnet B repels Magnet A.
- (2) The mass of Magnet A increased.
- (3) Magnet A is attracted to Magnet B.
- (4) Magnet A is a stronger magnet than Magnet B.

- 12 Four pupils set up their own experiment to compare the rates of evaporation of two different liquids, X and Y.

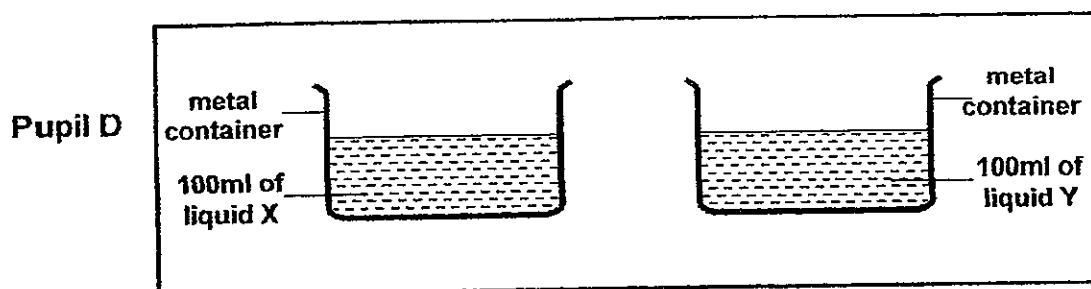
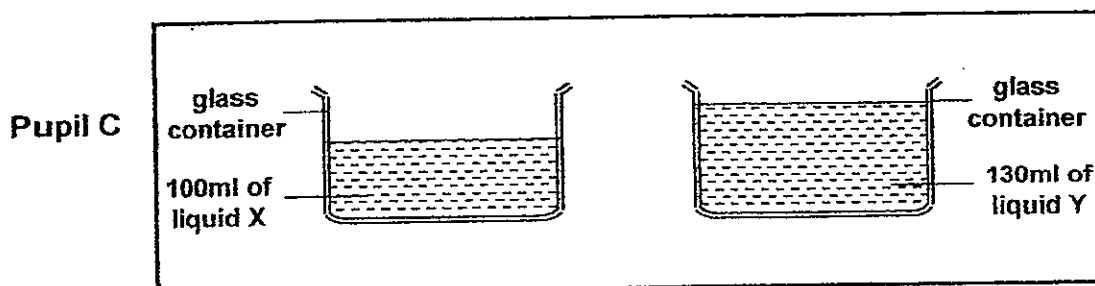
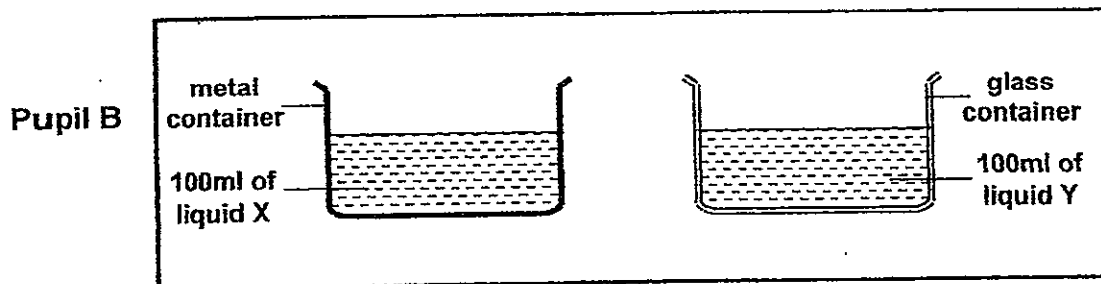
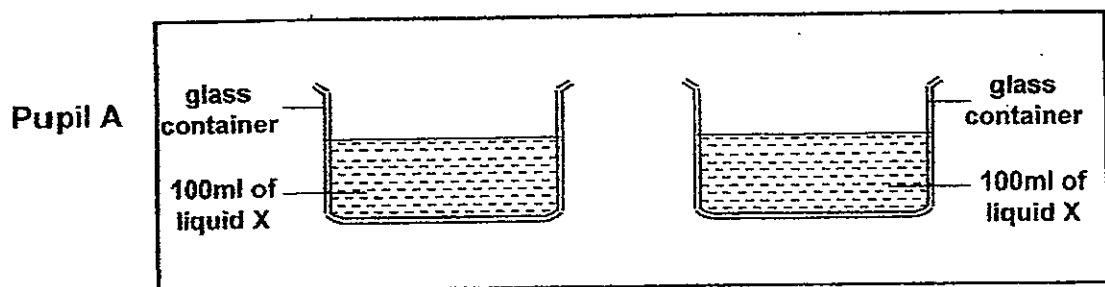

Which of the above pupils' set-ups will not give a fair test?

- (1) A and D only
- (2) B and C only
- (3) A, B and C only
- (4) B, C and D only

13 Byron set up an experiment as shown below.

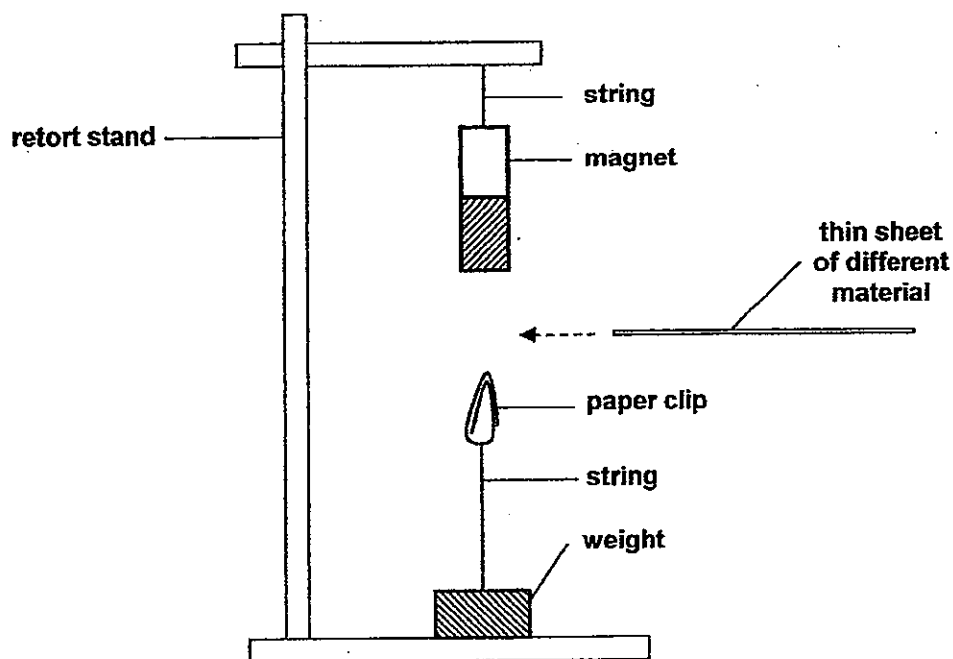

He had 2 thin sheets made of different materials, R and S. He moved each sheet of material directly under the magnet and observed what happened to the paper clip. He recorded his observation in the table below.

Thin sheet of material	Observation
R	Paper clip remains attracted to the magnet
S	Paper clip drops

He made the following conclusions based on the results obtained.

- A S must be a magnet
- B S can be magnetized
- C R is a non-magnetic material

Which of the above conclusions is/are definitely true?

- (1) C only
- (2) A and B only
- (3) B and C only
- (4) A, B and C

14 The flow chart shows parts of a body system.

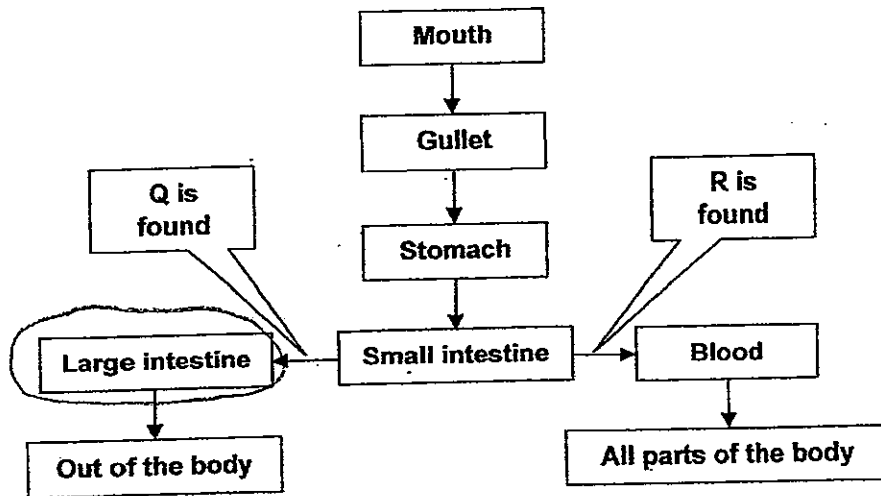

What do Q and R represent?

	Q	R
(1)	Carbon dioxide	Undigested food
(2)	Carbon dioxide	Oxygen
(3)	Undigested food	Digested food
(4)	Oxygen	Undigested food

15 Study the 4 different cells that are shown below.

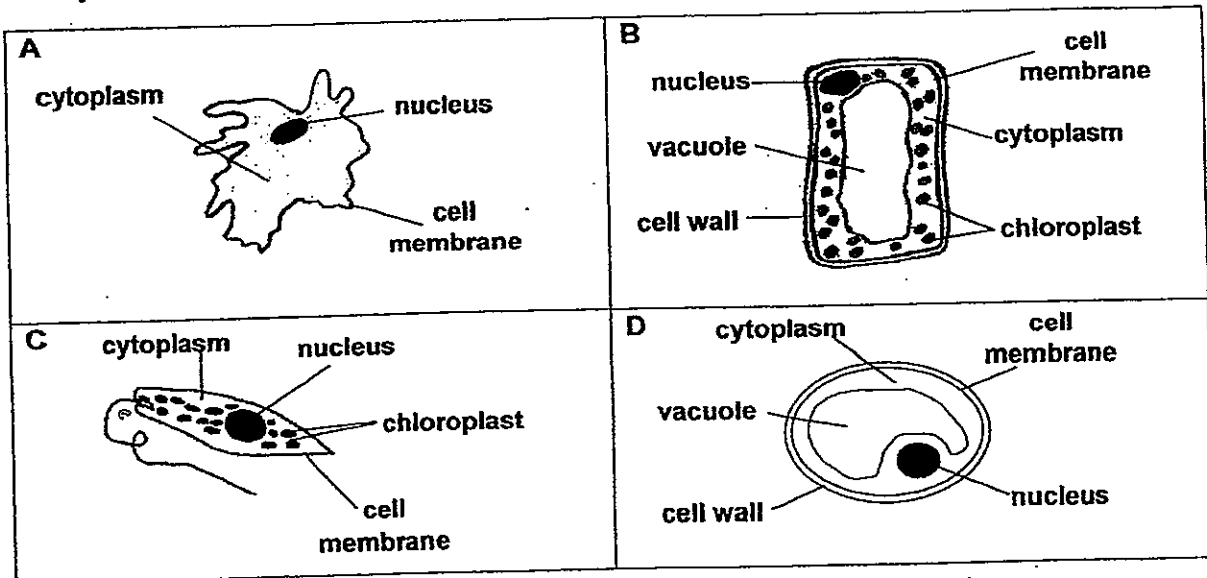

Which of the following is correct about the cells?

	Contains genetic information	Able to photosynthesize
(1)	A, D	A, B
(2)	B, C	A, C, D
(3)	A, B, C, D	B, C
(4)	A, B, C, D	B, C, D

105

16 A plastic pot with a plant was placed under a lamp as shown in the diagram below.

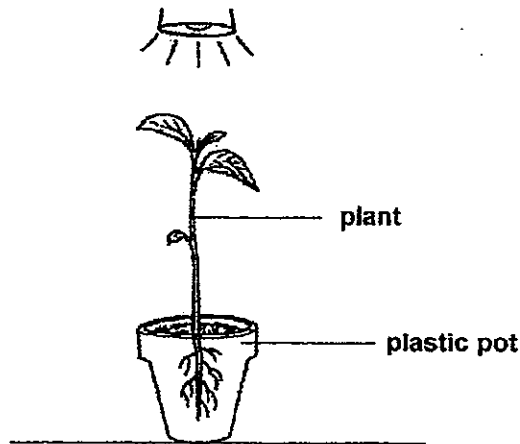

The pot was accidentally knocked over and left that way for two weeks. Which of the following shows how the plant will grow at the end of two weeks?

(1)

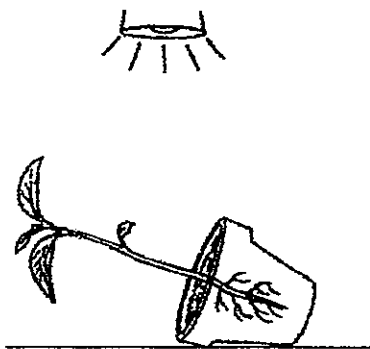

(2)

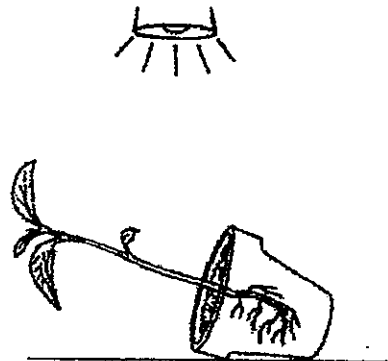

(3)

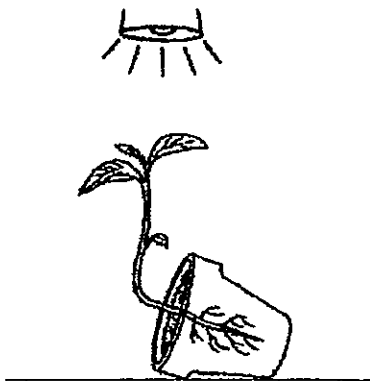

(4)

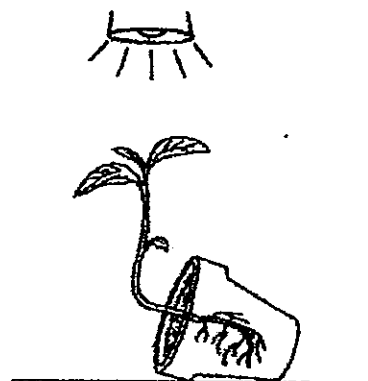

(3)

17 Ben removed part of the stem of a plant, together with the phloem, as shown in the diagram below. He left the plant in the garden and watered it daily.

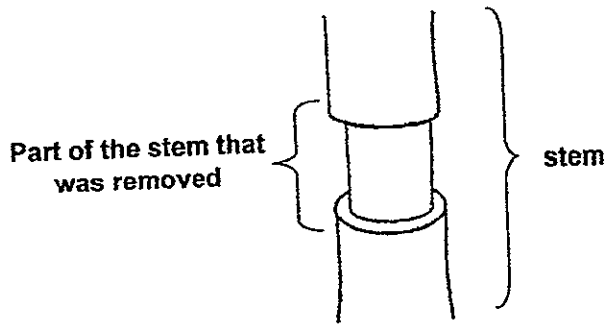

Which of the following diagrams shows how the stem of the plant will look like after a few days?

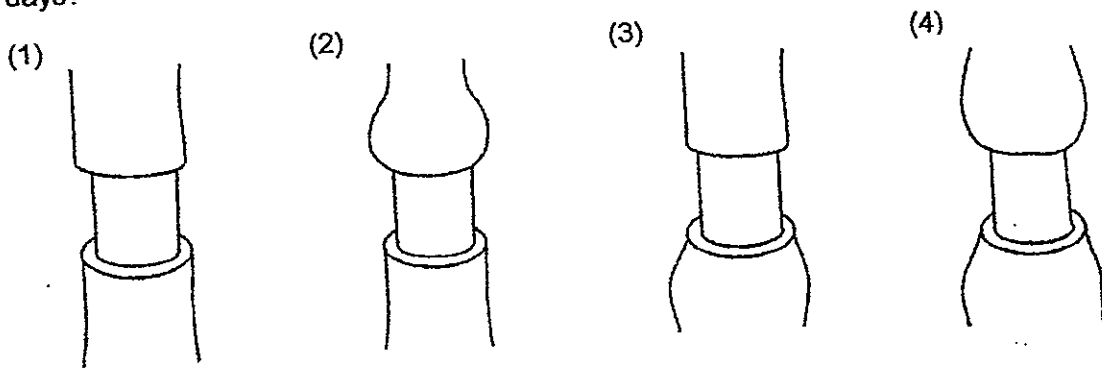

18 The diagram below shows the human respiratory system.

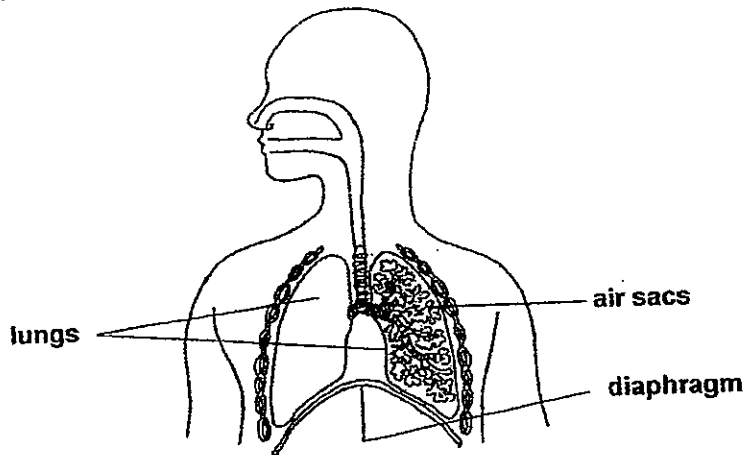

When we breathe in, the diaphragm _____ while our lungs _____.

	Diaphragm	Lungs
(1)	moves upwards	expand
(2)	moves downwards	contract
(3)	moves upwards	contract
(4)	moves downwards	expand

19 Four circuits were connected with bulbs and buzzers as shown below. In which two circuits will the buzzer ring the loudest?

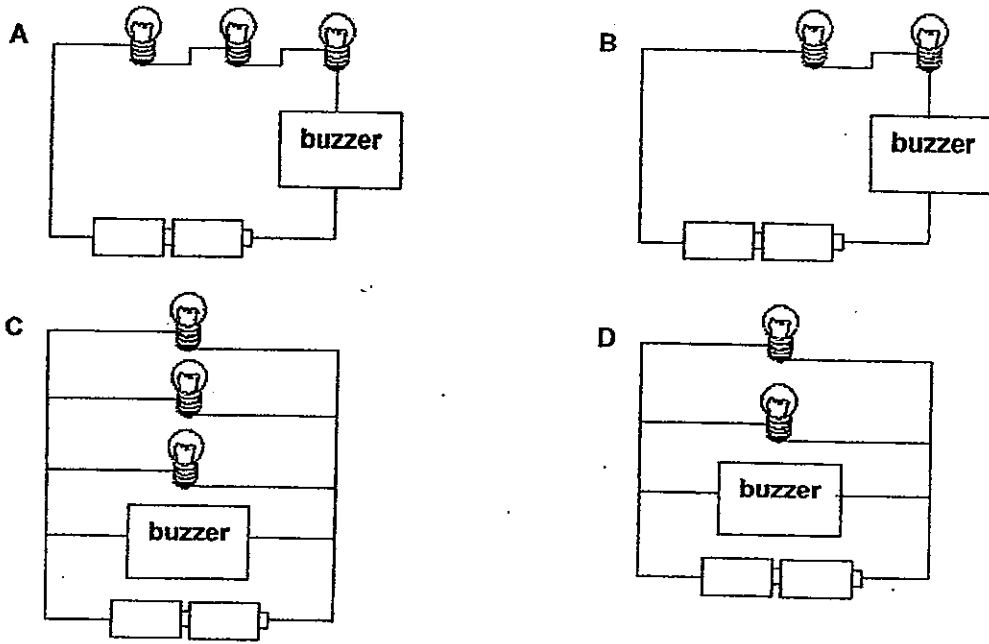

- (1) A and B
- (2) A and C
- (3) B and C
- (4) C and D

20 Alan used a circuit tester to test a circuit card. The results are shown in the table below.

Points on card connected to circuit tester	Does the bulb light up?
A and C	Yes
A and D	No
B and C	Yes
B and D	No
A and D	No

Which of the following circuit card was tested?

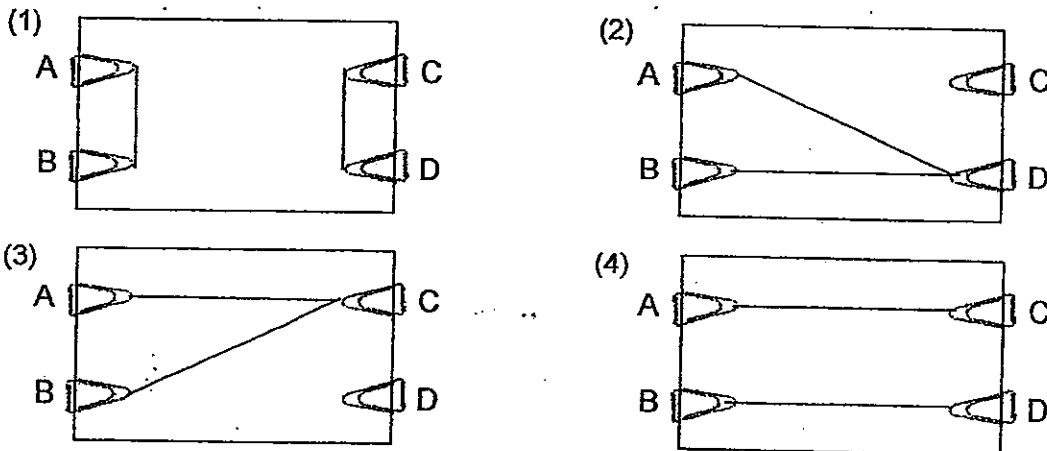

(3)

- 21 Dan placed two identical pots, A and B, on two metal plates of the same material but different surfaces. The pots contained the same amount of water at room temperature. The metal plates were heated from below.

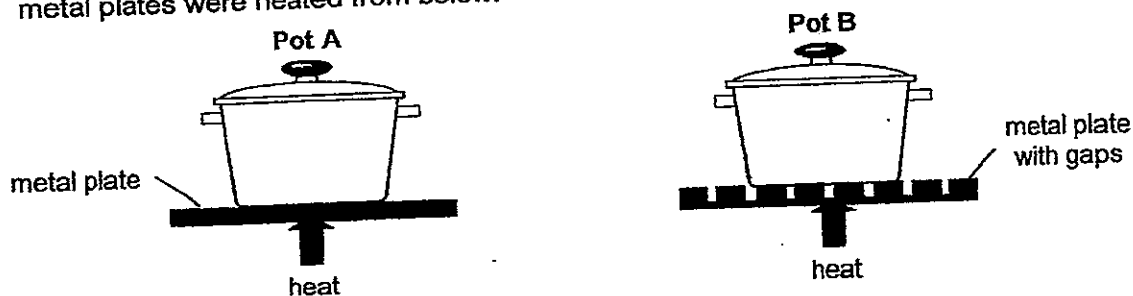

Which of the following reasons correctly explains why the water in that pot boils first?

	Pot	Reason
(1)	A	There is no gap in the metal plate so more heat is lost to the surroundings of the pot.
(2)	B	The gaps in the metal plate trap more heat that is transferred to the pot.
(3)	A	There is a greater surface area of contact between the metal plate and the pot, therefore more heat is transferred to the pot in a shorter time.
(4)	B	There is a smaller surface area of contact between the metal plate and the pot, therefore more heat is transferred to the pot in a shorter time.

- 22 Jim set up an experiment as shown below. He lighted the candle and observed that the pinwheel started to spin after a short while.

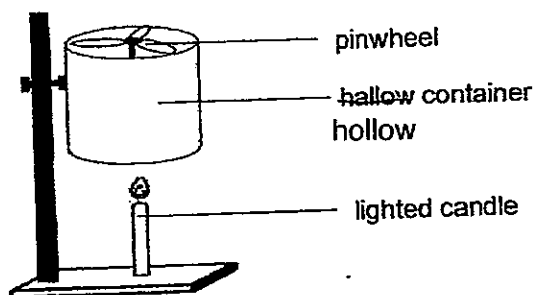

Which of the following shows the energy conversion that took place from the time the candle was lit till the pinwheel spun?

- (1) heat energy \rightarrow kinetic energy
- (2) potential energy \rightarrow heat energy + kinetic energy
- (3) chemical potential energy \rightarrow kinetic energy + light energy \rightarrow kinetic energy \rightarrow kinetic energy
- (4) chemical potential energy \rightarrow heat energy + light energy \rightarrow heat energy \rightarrow kinetic energy \rightarrow kinetic energy

- 23 Wei Zhi took a spring as shown below. He measured and recorded the original length as 10 cm.

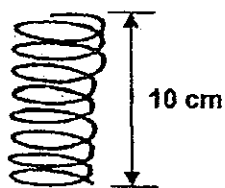

He used the spring to carry out a few experiments as shown below. Which of the experiments demonstrates that the spring has elastic potential energy?

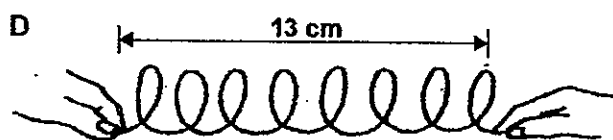
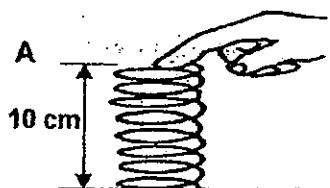

- (1) A and C only
 (2) B and D only
 (3) B, C and D only
 (4) A, B, C and D ~~X~~
- 24 Ali wanted to investigate if the mass of an object affects the amount of energy it possesses.

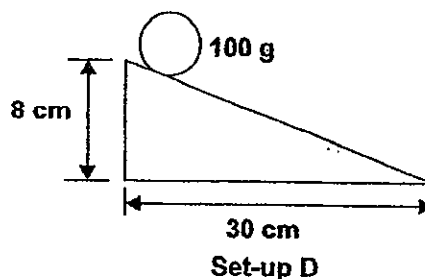
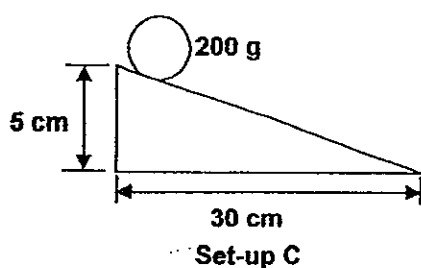
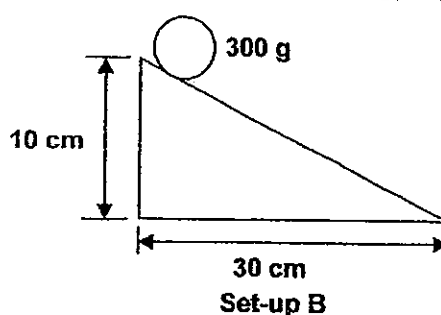
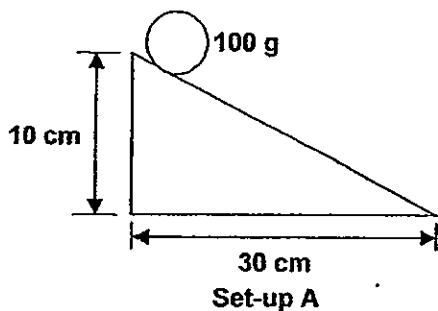

Which of the following set-ups should he use in his experiment?

- (1) A and B only
 (2) A and D only
 (3) B and C only
 (4) C and D only

25 Sam set up the experiment as shown below.

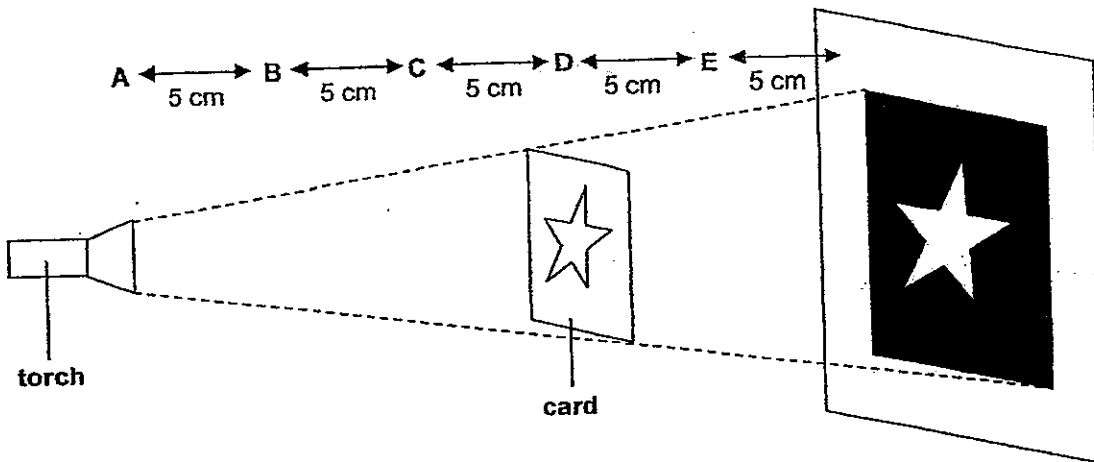

At which two positions, A, B, C, D and E, should Sam place the torch and card in order to increase the size of the shadow on the screen?

	Position of torch	Position of card
i	C	D
ii	A	E
iii	B	C
iv	A	B

- (1) ii only
 (2) i and ii only
 (3) iii and iv only
 (4) i, iii and iv only

ANGLO-CHINESE SCHOOL
(JUNIOR)



SEMESTRAL ASSESSMENT 2 (2012)
PRIMARY 5

SCIENCE

BOOKLET B

Tuesday

30 Oct 2012

1 hour 30 minutes

Name : _____ ()

Class : P5 _____

INSTRUCTIONS TO PUPILS

DO NOT TURN OVER THE PAGES UNTIL YOU ARE TOLD TO DO SO

Follow all instructions carefully.

There are 14 questions in this booklet.

Answer **ALL** questions.

INFORMATION FOR PUPILS

The number of marks is given in brackets [] at the end of each question or part question.

The total marks for this booklet is 40.

The total time for Booklets A and B is 1 hour 30 minutes.

This question paper consists of 12 printed pages. (Inclusive of cover page)

BOOKLET A	/ 50
BOOKLET B	/ 40
TOTAL	/ 90
Parent's signature/ Date:	

For questions 26 to 39, write your answers in this booklet.

The number of marks available is shown in the brackets [] at the end of each question or part question. (40 marks)

26 Study the flow chart below.

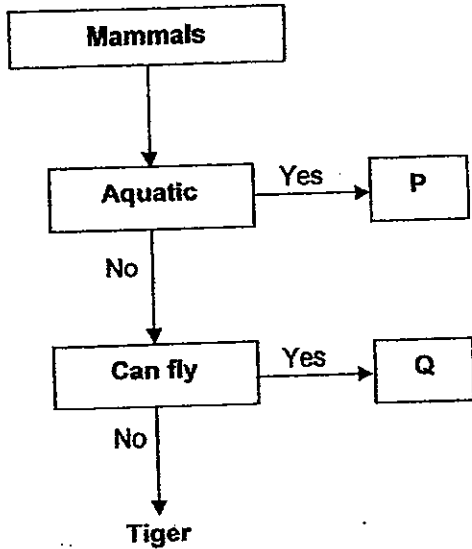

(a) Based on the flow chart, what can P and Q be? [1]

P: _____

Q: _____

(b) Besides giving birth to their young alive, what are two other characteristics of mammals shared between P and Q? [1]

(Go on to the next page) 113

SCORE	2
-------	---

27 In an experiment, Tom wants to find the volume of a stone. He has the following:

1. A stone.
2. A beaker filled with 50 cm^3 of water.
3. An empty beaker with a capacity of 100 cm^3 .

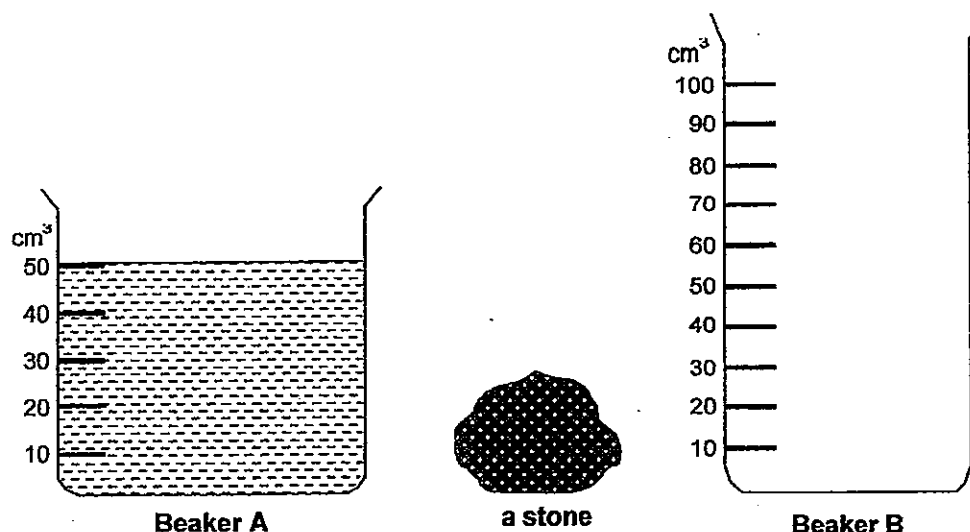

- (a) Select the correct four steps that Tom should take to find the volume of the stone. Order the steps by writing 1, 2, 3 and 4 in the correct boxes below. [1]

Step	Description
	Put the stone into Beaker A and measure the volume.
	Pour all the water in Beaker A into Beaker B.
	Put the stone into Beaker B.
	Add the volume of water in Beaker A and the volume of stone.
	Measure the volume of water and stone in Beaker B.
	Subtract the volume of water that was in Beaker A from the volume of water and stone in Beaker B.

- (b) Based on the experiment, what can you infer about the property of solid? [1]

(Go on to the next page)

SCORE	2
-------	---

28 The pictures below show the locations of three types of fruit trees, A, B and C, on an island 2 years ago and at the present.

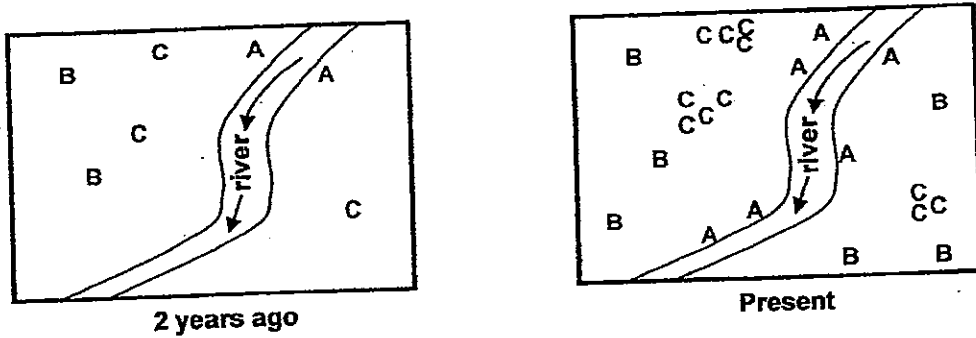

(a) Complete the table below with the possible method of dispersal for the fruits of fruit trees B and C. [1]

Type	Dispersal Method
B	
C	

(b) State two characteristics of the fruits of fruit tree A. [1]

(c) Explain why plants need to disperse their seeds. [1]

29 The diagram shows part of the circulatory system of an animal.

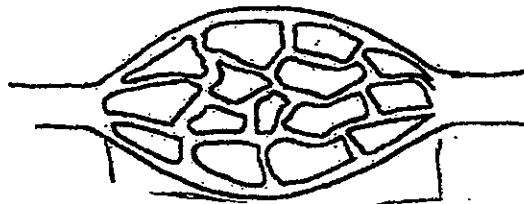

(a) On the diagram, indicate and label the capillaries. [1]

(b) Besides carbon dioxide and oxygen, name two other substances that are transported in the circulatory system of animals. [1]

(c) Which parts of a plant performs the same function as the circulatory system in animals. [1]

(Go on to the next page) 115

SCORE	
	6

30 The diagram below shows two stages in the process of human sexual reproduction.

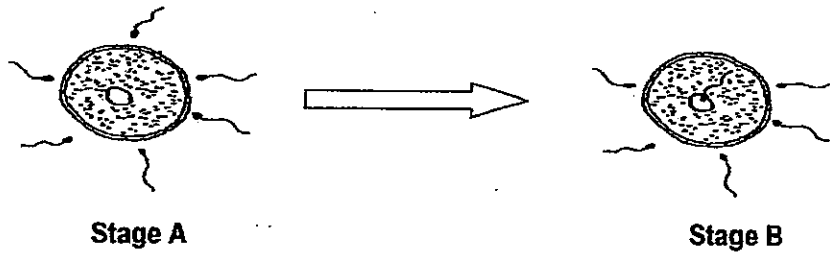

(a) Name the process at Stage B. [1]

(b) What will happen to the egg cell after Stage B? [1]

(c) The umbilical cord connects the developing baby to the mother. Name two substances that are transported through it? [1]

31 Calvin placed a healthy plant in a beaker of blue coloured water as shown in the diagram below. He poured a layer of oil into to the beaker of water.

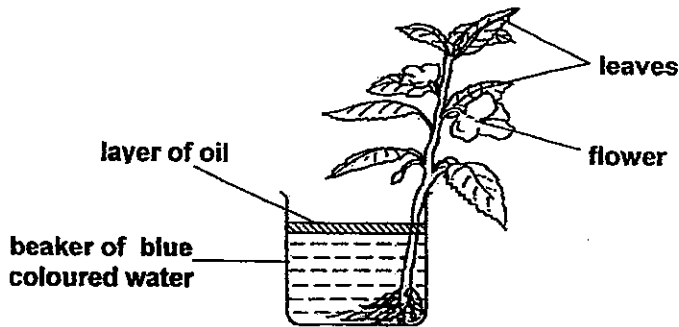

(a) What changes would he observe after four days? [1]

(b) What is the purpose of the layer of oil in the set-up? [1]

(c) What was the aim of Calvin's experiment? [1]

(Go on to the next page)

32 Craig created a simple set-up to represent a water cycle.

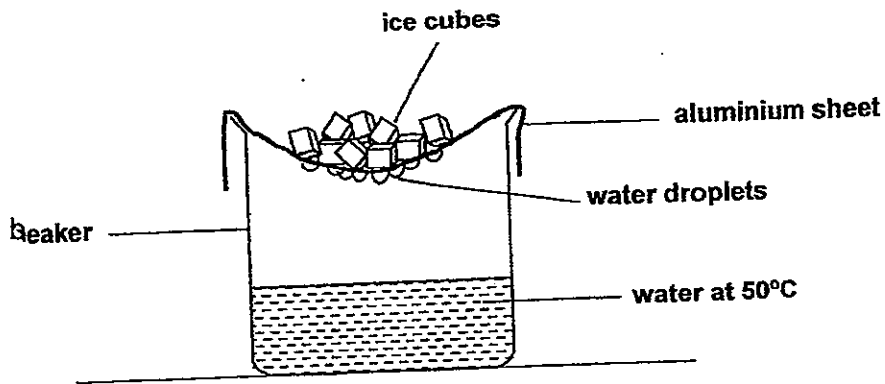

(a) Why did he place ice cubes on the aluminium sheet? [1]

(b) Describe how the water droplets formed under the aluminium sheet? [1]

Craig repeated the experiment but replaced the water in the beaker with boiling water.

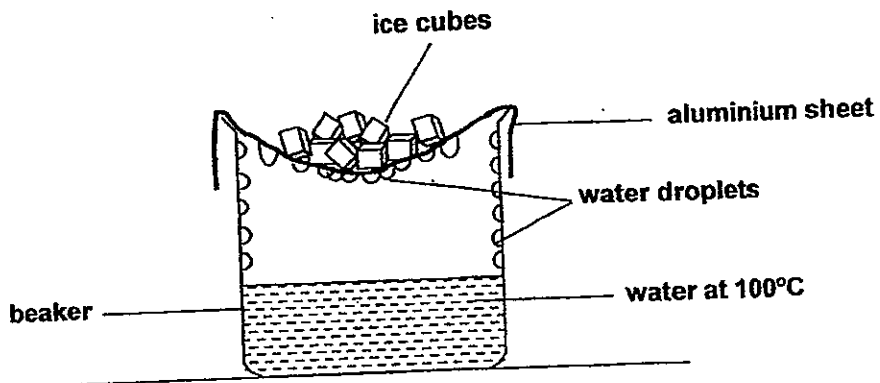

(c) There were more water droplets under the aluminium sheet and some water droplets also formed on the inner side of the beaker. Explain why this happened. [1]

(Go on to the next page) 117

SCORE	3
-------	---

33 Based on a recent study, a factory was found to have illegally discharged chemicals into a river where organisms Q and R were found. The chemical dumping was done from the year 2004 to 2006. During that period, it was found that organism Q was badly affected by the chemicals while organism R was not affected by it.

- (a) On the graph below, draw and label the line graphs to show the changes in the number of organism Q and R from the year 2002 to 2010. [2]

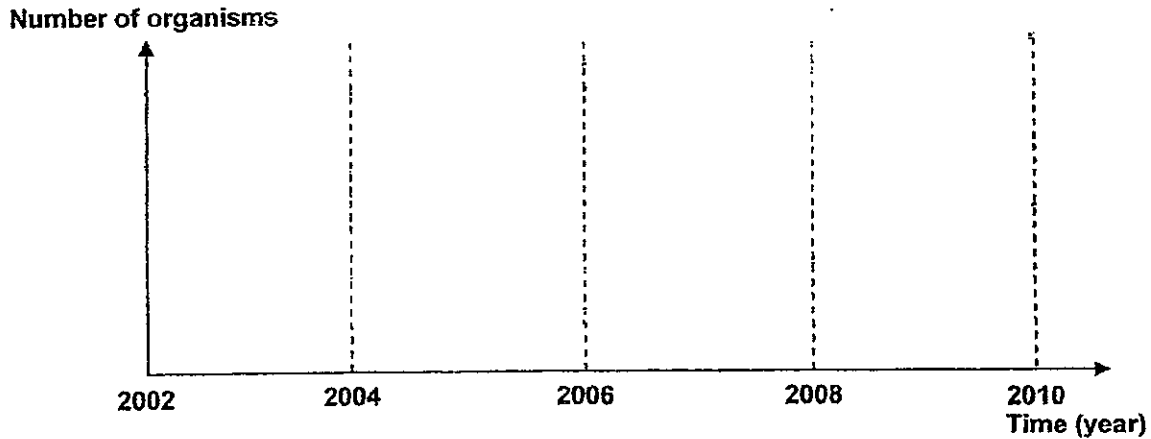

- (b) Besides chemical dumping, state two other possible activities that can cause water pollution. [1]

34 Jinghao has a plate of iron filings and sawdust mixture. He wants to separate the iron filings from the sawdust and place the iron filings on Plate X.

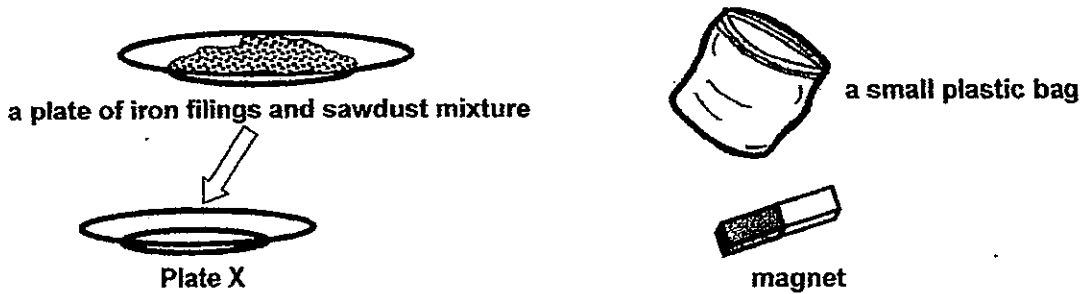

- (a) With the given materials, a magnet and a small plastic bag, how can he place the iron filings onto Plate X? [2]

- (b) Name the characteristic of magnet shown in (a). [1]

(Go on to the next page)

SCORE	/
	6

35 Study the diagram below.

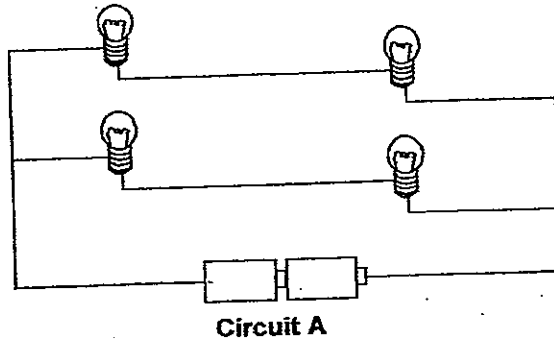

(a) How many bulbs would remain lit when one of the bulbs in the circuit blows? [1]

(b) Draw a circuit diagram below to show how the four bulbs can be connected so that they can be switched on and off individually. The batteries have been drawn for you. [1]

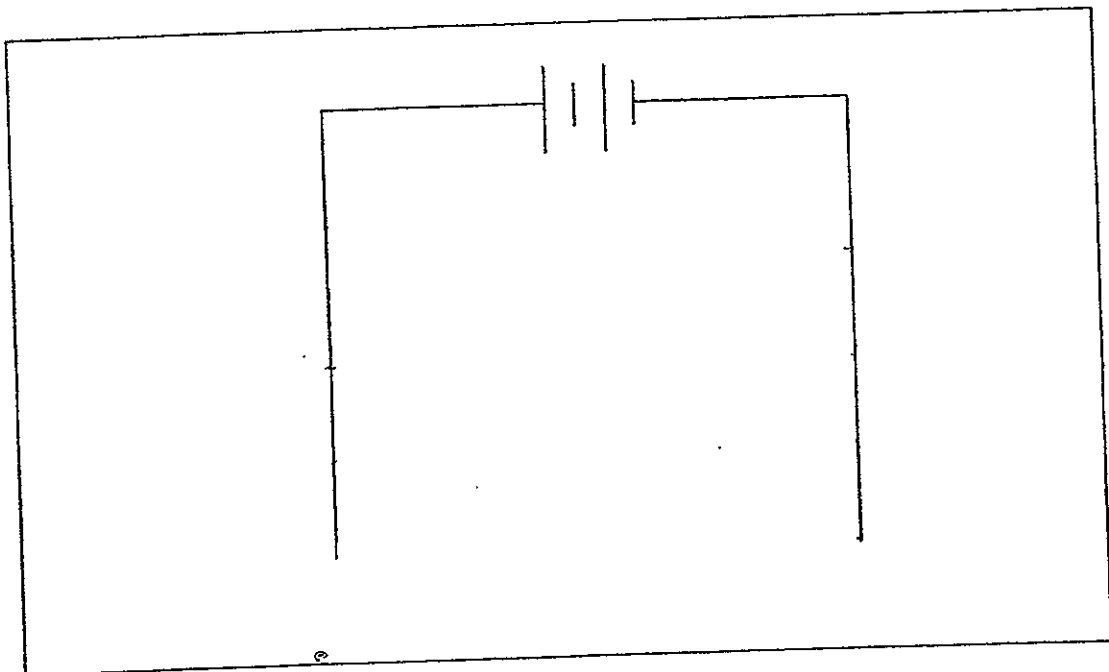

(c) Name another advantage of the circuit diagram that you have drawn in (b) as compared to Circuit A. [1]

SCORE	3
-------	---

36 In the circuit below, four bulbs, B1, B2, B3 and B4 and four switches, S1, S2, S3 and S4 are connected to two identical batteries.

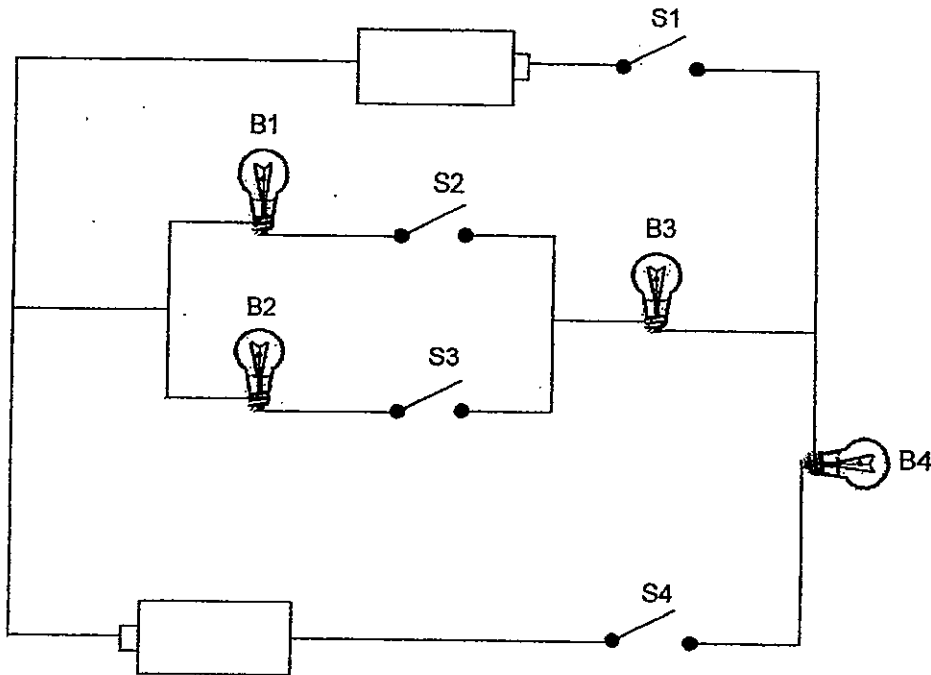

(a) In the table below, put a tick (✓) in the correct boxes to show that a bulb lights up when the switches are opened and closed in the following combinations. [1]

Switches				Bulb lights up			
S1	S2	S3	S4	B1	B2	B3	B4
closed	closed	closed	open				
closed	open	closed	open				

b) In the table below, write the letter "O" for opened or "C" for closed for each switch if the bulb(s) light up based on the following combinations. [1]

Switches				Bulb lights up			
S1	S2	S3	S4	B1	B2	B3	B4
							✓
					✓	✓	✓

(c) How are bulbs B1 and B2 arranged with respect to bulb B3 in the circuit? [1]

(Go on to the next page)

SCORE	3
-------	---

37 Chris conducted the experiment shown in the set-up below.

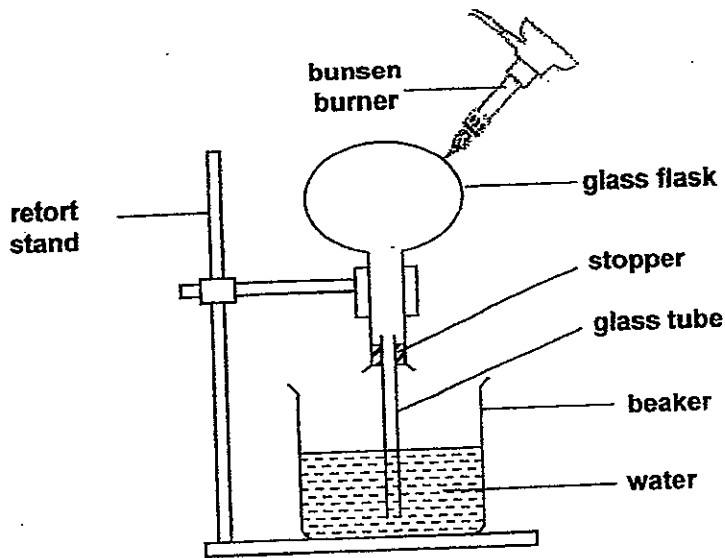

He heated the flask with a bunsen burner. After two minutes, he observed a few bubbles in the beaker of water.

(a) Explain how the bubbles in the beaker of water formed. [2]

(b) What can Chris do to the set-up to increase the number of bubbles formed in the beaker of water? [1]

(Go on to the next page)

SCORE	3
-------	---

38 The diagram below shows a ball at 4 different positions immediately after it was released from the top of the ramp.

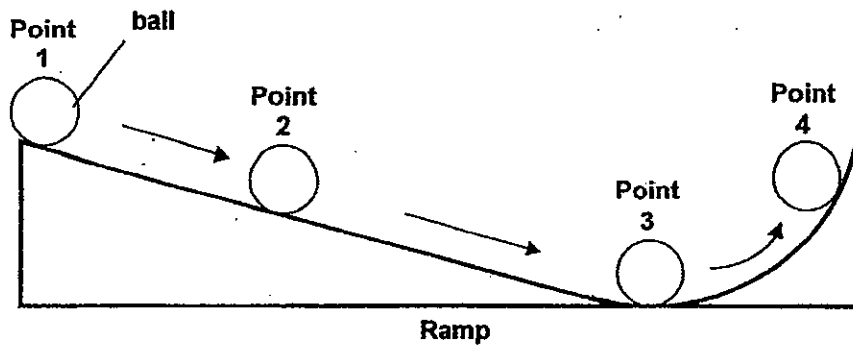

(a) What energy(s) did the ball has/have at Point 2? [1]

(b) The graph shows the changes in the amount of gravitational potential energy as the ball moves over a period of time. Place 2 crosses (x) on the graph to represent Points 1 and 3 and label them. [1]

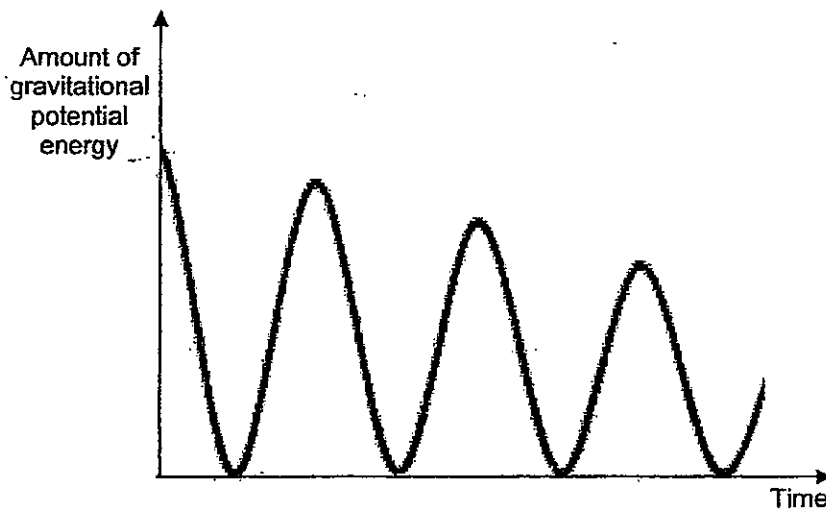

(c) Why did the gravitational potential energy of the ball decrease over the period of time? [1]

(Go on to the next page)

SCORE	3
-------	---

39 The diagrams below show two power stations.

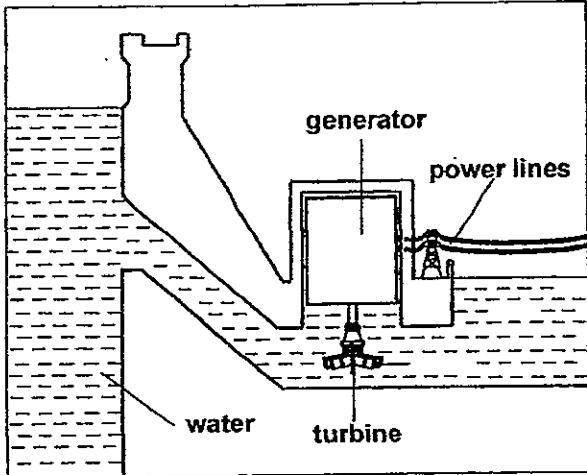

Power station A

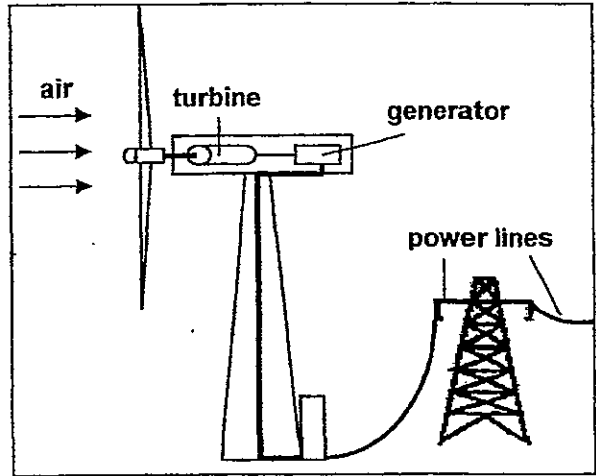

Power station B

(a) What is the source of energy for each of the power stations? [1]

(i) Power station A - _____

(ii) Power station B - _____

(b) What is the advantage of using Power Station A as compared to a power station that uses fossil fuels to produce electricity? [1]

(c) What is the disadvantage of using Power Station B as compared to Power Station A? [1]

End of Paper

SCORE	3
-------	---

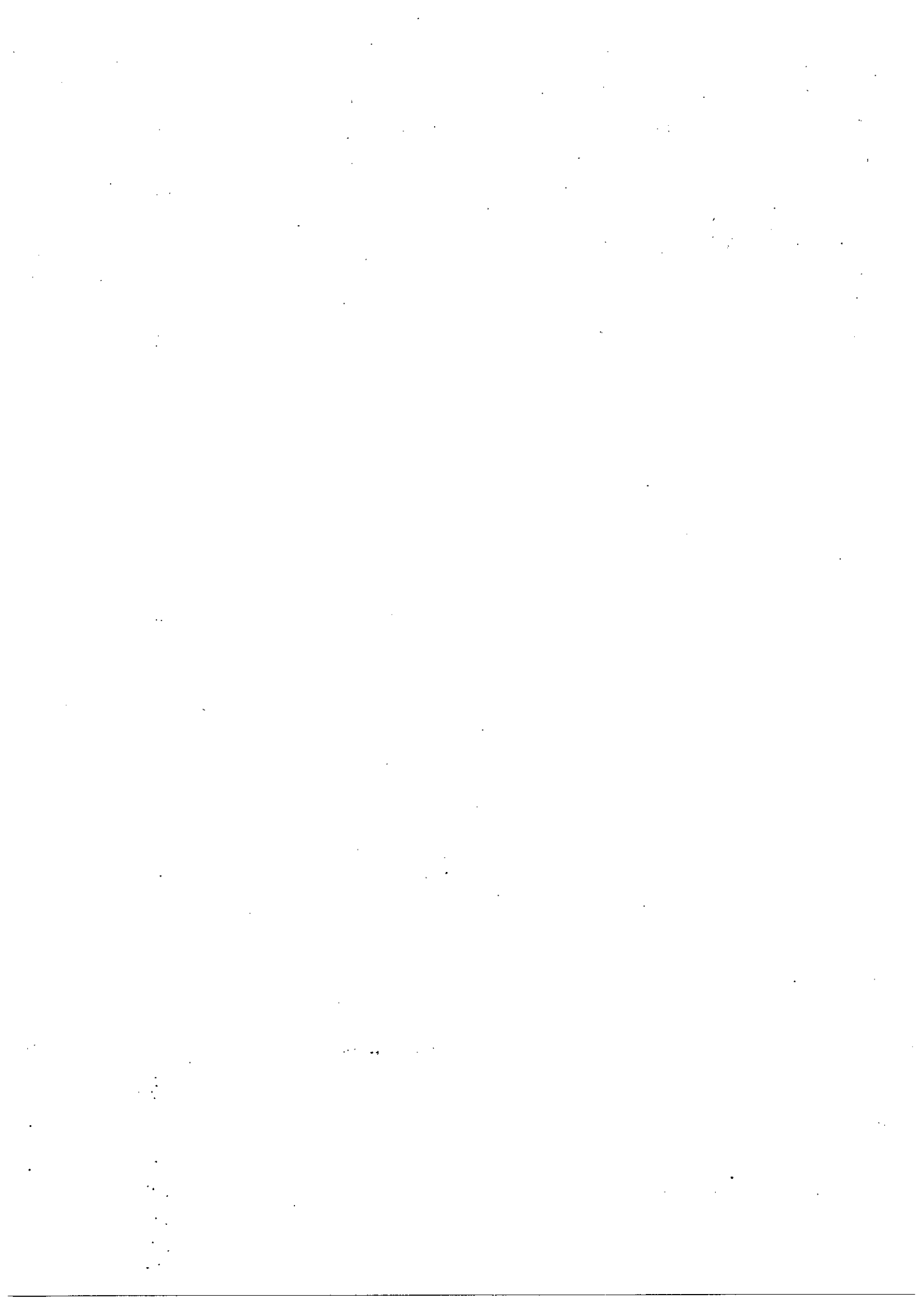

ANSWER SHEET

EXAM PAPER 2012

SCHOOL : ACS

SUBJECT : PRIMARY 5 SCIENCE

TERM : SA2

Q1	Q2	Q3	Q4	Q5	Q6	Q7	Q8	Q9	Q10	Q11	Q12	Q13	Q14	Q15	Q16	Q17
2	2	2	2	3	4	3	3	1	4	3	3	3	3	3	4	2

Q18	Q19	Q20	Q21	Q22	Q23	Q24	Q25
4	4	3	3	4	3	1	4

26)a)P: whale Q: Bat

b)Both animals have hair as their outer covering and lungs.

27)a) -, 1, 2, -, 3, 4

b)Solid occupies space and has a definite volume.

28)a)B: Wind dispersal. C: Explosive dispersal.

b)The fruits are waterproof and have a thick husk that allows them to stay afloat on water.

c)They need to disperse to avoid overcrowding and competition for nutrients.

29)a)

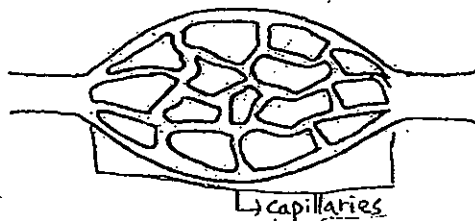

- 29)b) Digested food substances and water.
 c) Phloem and xylem tubes.

- 30)a) Fertilisation.
 b) It will undergo cell division.
 c) Oxygen and digested food.

- 31)a) The leaves and flower of the plant will turn blue and the water level will decrease.
 b) It is to prevent loss of water through evaporation.
 c) It was to prove that roots take in water for the plant for photosynthesis.

- 32)a) So that water vapour can condense on the cool underside of the aluminium sheet to form water droplets.
 b) The water in the beaker evaporated. When the water vapour came into contact with the cool surface of the aluminium sheet, it condensed and formed tiny water droplets.
 c) The water vapour is at a higher temperature than the previous experiment and hence condenses faster and more easily on the relatively cooler surface of the aluminium sheet and inner side of the beaker forming more more water droplets.

33)a)

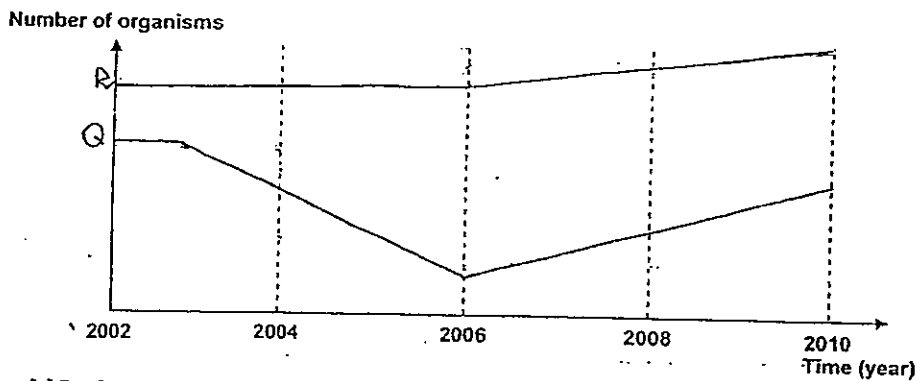

- b) Deforestation and oil spillage.

- 34)a) Jinghao can place the magnet into the small plastic bag, and then place it into the mixture of iron and sawdust filings. The filings will be attracted to the plastic with magnetism side put the plastic bag on plate X. Remove the magnet from the bag. All the iron filings will drop on plate X.
 b) Magnet can attract magnetic materials.

35)a) 2 bulbs.

35)b)

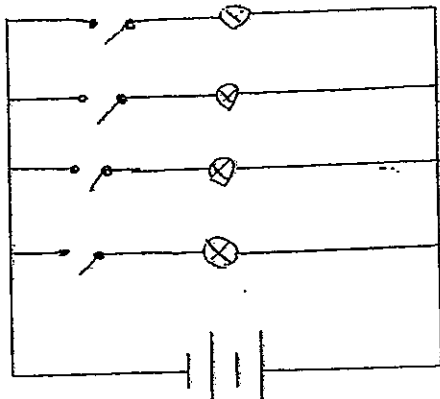

c)The batteries can last longer.

36)a) ✓ ✓ ✓

✓ ✓

b) C O O C

O O C C

c)They are arranged in series with respect to B3.

37)a)The Bunsen burner heats up the glass flask, causing the hot air inside to expand. When there is too much air inside, air will escape as air bubbles in the beaker of water.

b)Chris can increase the number of Bunsen burners.

38)a)Kinetic energy and Gravitational Potential energy.

c)Some of the gravitational potential energy of the ball has been converted to sound energy and heat energy.

39)a)i)Water ii)Wind energy

b)Power station A uses water that can be renewable but a power station that uses fossil fuels cannot be renewable.

c)When there us no wind, power station B cannot be used.

38b)

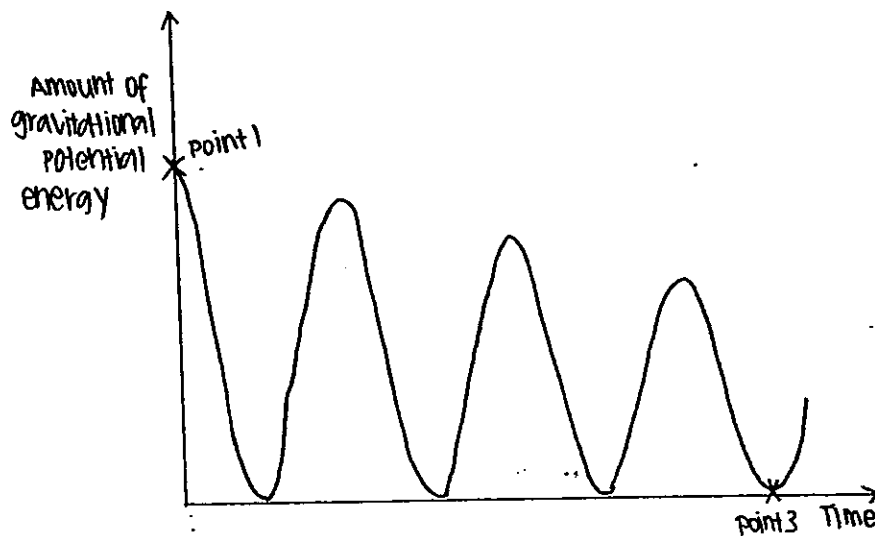

Page 3

127

End

